

Christie Velvet – Merit Series

1.5mm Indoor LED tile

Technical specifications		Christie LED015-M
Display technology	pixel pitch	• 1.5mm
	pixel configuration	• 3-in-1 (1R1G1B)
	pixel density	• 422,500 pixels/m ²
	maximum calibrated brightness	• 800 nits (cd/m ²)
	aspect ratio	• 1:1
	contrast ratio (full field)	• 5000:1
	viewing angle	• 160° H, 140° V
	refresh rate	• ≥3200Hz
	scan rate	• 1/26
	color temperature	• 2700-9300K
	color space	• 110% NTSC
	display colors	• 281 trillion
	Signal	inputs
Power	input rating	• 100-240 VAC @ 50-60Hz
	power consumption per cabinet	• 50W typical • 160W maximum
	heat output	• 246 BTU/hr typical • 737 BTU/hr maximum
Environment	operating temperature	• 32-104°F (0-40°C)
	operating humidity	• 10-90% non-condensing
	storage temperature	• 14-131°F (-10-55°C)
	environment	• Indoor
	IP rating	• 30
	LED lifespan (50% brightness)	• 100,000 hrs
	runtime	• 24/7
	Physical	tile dimensions (installed)
tile area		• 2.48 ft ² (0.2304m ²)
tile resolution		• 312 x 312 pixels
tile weight		• 23.4lbs (11.5kg)
cabinet design		• Die-cast aluminum
service access		• Front and rear service only
module dimensions		• (WxH): 9.45 x 4.72" (240.0 x 120.0mm)
module resolution		• 156 x 78 pixels
installation options		• Flat • hanging • concave
stacking height		• 20 units ¹
orientation		• 360 degrees ²
Certification	• UL60950 • FCC • CE • EMC RoHS, RCM	
Warranty	<ul style="list-style-type: none"> • Three year parts and labor limited warranty • Contact an authorized Christie representative for full details of our limited warranty • Extended warranty option available for a one-time fee at time of purchase 	

¹ With appropriate structure. Contact Christie if height exceeds 20 units.

² Varies by local building codes.

Front view

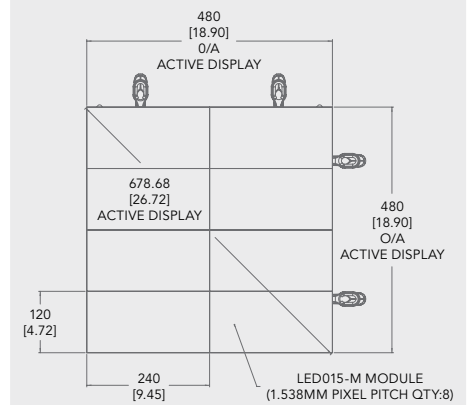

Back view

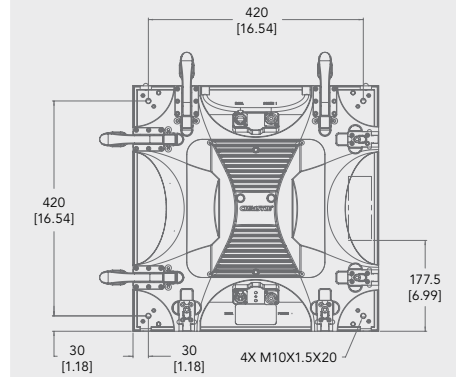

Side view

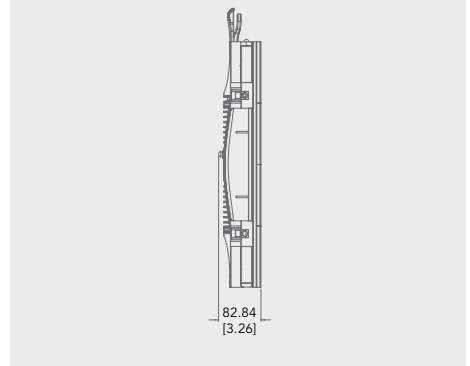

Corporate offices

Christie Digital Systems USA, Inc.
Cypress
ph: 714 236 8610

Christie Digital Systems Canada Inc.
Kitchener
ph: 519 744 8005

Worldwide offices

Australia
ph: +61 (0) 7 3624 4888

Brazil
ph: +55 (11) 2548 4753

China (Beijing)
ph: +86 10 6561 0240

China (Shanghai)
ph: +86 21 6278 7708

France
ph: +33 (0) 1 41 21 44 04

Germany
ph: +49 2161 664540

India
ph: +91 (080) 6708 9999

Japan (Tokyo)
ph: 81 3 3599 7481

Korea (Seoul)
ph: +82 2 702 1601

Mexico
ph: +52 55-4744-1790

Republic of South Africa
ph: +27 (0) 11 510 0094

Russian Federation and Eastern Europe
ph: +36 (0) 1 47 48 100

Singapore
ph: +65 6877 8737

Spain
ph: +34 91 633 9990

United Arab Emirates
ph: +971 4 3206688

United Kingdom
ph: +44 (0) 118 977 8000

United States (Arizona)
ph: 602 943 5700

United States (New York)
ph: 646 779 2014

Independent sales consultant offices

Italy
ph: +39 (0) 2 9902 1161

For the most current specification information, please visit www.christiedigital.com



Copyright 2015 Christie Digital Systems USA, Inc. All rights reserved. All brand names and product names are trademarks, registered trademarks or tradenames of their respective holders. Christie Digital Systems Canada Inc.'s management system is registered to ISO 9001 and ISO 14001. Performance specifications are typical. Due to constant research, specifications are subject to change without notice. Printed in Canada on recycled paper. 4147 Nov 15

CHRISTIE