

User Guide
020-103845-06

CineLife+ 2.0

CHRISTIE®

NOTICES

COPYRIGHT AND TRADEMARKS

Copyright © 2026 Christie Digital Systems USA Inc. All rights reserved.

All brand names and product names are trademarks, registered trademarks or trade names of their respective holders.

GENERAL

Every effort has been made to ensure accuracy, however in some cases changes in the products or availability could occur which may not be reflected in this document. Christie reserves the right to make changes to specifications at any time without notice. Performance specifications are typical, but may vary depending on conditions beyond Christie's control such as maintenance of the product in proper working conditions. Performance specifications are based on information available at the time of printing. Christie makes no warranty of any kind with regard to this material, including, but not limited to, implied warranties of fitness for a particular purpose. Christie will not be liable for errors contained herein or for incidental or consequential damages in connection with the performance or use of this material. Our centers of excellence for manufacturing in Kitchener, Ontario, Canada and in Shenzhen, China are ISO 9001:2015 Quality Management System-certified.

Christie is committed to making our documents free from language bias; however, we are not responsible for the language used on any linked or third-party documentation.

For the most current technical documentation and office contact information, visit <https://www.christiedigital.com/>.

Warranty

Products are warranted under Christie's standard limited warranty, the details of which are available at <https://www.christiedigital.com/help-center/warranties/> or by contacting your Christie dealer or Christie.

PREVENTATIVE MAINTENANCE

Preventative maintenance is an important part of the continued and proper operation of your product. Failure to perform maintenance as required, and in accordance with the maintenance schedule specified by Christie, voids the warranty. For preventative maintenance schedules, refer to www.christiedigital.com.

REGULATORY

The product has been tested and found to comply with the limits for a Class A digital device, pursuant to Part 15 of the FCC Rules. These limits are designed to provide reasonable protection against harmful interference when the product is operated in a commercial environment. The product generates, uses, and can radiate radio frequency energy and, if not installed and used in accordance with the instruction manual, may cause harmful interference to radio communications. Operation of the product in a residential area is likely to cause harmful interference in which case the user will be required to correct the interference at the user's own expense. Changes or modifications not expressly approved by the party responsible for compliance could void the user's authority to operate the equipment

CAN ICES-3 (A) / NMB-3 (A)

이 기기는 업무용(A급)으로 전자파적합등록을 한 기기이오니 판매자 또는 사용자는 이점을 주의하시기 바라며, 가정 외의 지역에서 사용하는 것을 목적으로 합니다.

ENVIRONMENTAL



The product is designed and manufactured with high-quality materials and components some of which can be recycled and reused. This symbol  means electrical and electronic equipment, at their end-of-life, should be disposed of separately from regular waste. Please dispose of the product appropriately and according to local regulations. In the European Union, separate collection systems are for used electrical and electronic products.

If printing this document, consider printing only the pages you need and select the double-sided option.

Please help us to conserve the environment we live in!

Notation

Learn the hazard and information symbols used in the product documentation.



Danger messages indicate a hazardous situation which, if not avoided, results in death or serious injury.



Warning messages indicate a hazardous situation which, if not avoided, could result in death or serious injury.



Caution messages indicate a hazardous situation which, if not avoided, could result in minor or moderate injury.



Notice messages indicate a hazardous situation which, if not avoided, may result in equipment or property damage.



Information messages provide additional information, emphasize or provide a useful tip.

Content

Important safety guidelines.	10
General safety precautions.	10
AC power precautions.	11
Laser safety precautions.	11
Lamp safety precautions.	12
Light intensity hazard distance.	12
Introduction.	15
Software version.	15
Models.	15
What's new in the guide?.	15
Accessing product documentation.	16
Cinema calculator tool.	17
Viewing Christie University product training videos.	17
Technical support.	17
Operating the projector.	18
Projector power modes.	18
System operation for CP4440-RGB, CP4445-RGB, CP4450-RGB, and CP4455-RGB projectors only.	19
Turning on or off the projector.	19
LED status indicators.	19
Logging into the projector.	20
Logging out of the projector.	20
Changing the session timeout.	20
Determining the projector IP address.	21
Resetting the projector IP address to the default.	22
Using the web user interface (Web UI).	23
Turning on or off the touch panel.	23
Understanding the Christie touch panel interface and web user interface.	24
Enabling service mode.	25
Disabling service mode.	25
Turning on the light source with service mode enabled.	26
Turning on or off the light source.	26
Opening or closing the shutter.	26

Adding a network time protocol server.	27
Deleting a network time protocol server.	27
Changing the time zone.	27
Changing the time format.	28
Changing the date format.	28
Changing the orientation of the projected image.	28
Changing the projector hostname.	29
Changing the temperature display.	29
Disabling serial authentication requirement.	29
Viewing system status information.	29
Video Input panel.	31
HDMI video source.	34
SDI video source.	34
DisplayPort video source.	35
Integrated Media Block (IMB) video source.	35
HDMI video source connection from an Integrated Media Block (IMB).	35
SDI video source connection from an Integrated Media Block (IMB).	36
GPIO connector.	36
3D sync connector.	38
Hibernate mode.	40
Enabling hibernate mode.	40
Waking up from hibernate mode.	40
Managing the laser light source.	42
Creating a new laser file for non-chiller RGB projectors.	42
Creating a new laser file for RGBH projectors.	43
Creating a new laser file for external chiller-based projectors.	44
Modifying an existing laser file.	45
Copying existing laser settings to a new file.	45
Deleting a laser file.	46
LiteLOC™ sensor-to-screen calibration	46
LiteLOC™ sensor-to-screen calibration: Workflow.	46
Creating a new calibration file.	47
Recalibrating an existing calibration file.	48
Editing the existing calibration file parameters.	49
Verifying the sensor-to-screen calibration	50
Adding a calibration file to the Channel Setup.	50

Managing the lamp. 51

- Turning on the lamp. 51
- Turning off the lamp. 51
- Adjusting the lamp power. 51
- Changing the lamp power percentage. 51
- Enabling lamp overdrive. 52
- Using LampLOC™ to adjust the lamp position. 52
- Manually adjusting the lamp position. 52
- Viewing lamp information. 53
- Setting a lamp warranty date alarm. 53
- Setting a lamp half-life alarm. 53
- Lamp power ratings and warranty hours. 53

Managing user accounts. 55

- Roles and permissions. 55
- Adding a user account. 56
- Changing user account permissions. 56
- Changing a user account password. 56
- Deleting a user account. 56

Network settings. 57

- Connecting the projector to the theater network. 57
- Activating SNMP. 57
- Downloading MIB information. 58

Managing content, playlists, and storage. 59

- Customizing 3D mover delay. 59

Setting up an integrated media block. 60

- Selecting Integrated Media Block (IMB) preferences. 60
- Activating marriage. 60
- Enabling Integrated Media Block (IMB) Powered in Standby mode. 61

Working with channels. 62

- Adding a channel for HDMI input. 62
- Adding a channel for SDI input. 63
- Adding a channel for DisplayPort input. 65
- Adding a channel for Integrated Media Block (IMB) input. 66
- Selecting the active channel. 67

Editing an existing channel.	67
Renaming a channel.	68
Copying existing channel settings to a new channel.	68
Viewing the channel list.	68
Moving a channel up or down the channel list.	68
Deleting a channel.	69
Managing color setting files.	70
Custom color space conversion files.	70
Importing a custom color space file.	73
Creating an MCGD file.	73
Editing an existing MCGD file.	73
Copying existing MCGD file settings to a new file.	74
Deleting an MCGD file.	74
Creating a TCGD file.	74
Editing an existing TCGD file.	75
Copying existing TCGD file settings to a new file.	75
Deleting a TCGD file.	75
Managing EDID files.	76
Importing an EDID file.	76
Deleting an EDID file.	76
Adjusting the image size and position.	77
Intelligent Lens System (ILS).	77
Activating the Intelligent Lens System.	77
Creating a new ILS file.	77
Automatically calibrating the ILS.	78
Editing ILS file settings.	78
Copying existing ILS file settings.	78
Deleting an ILS file.	78
Resetting the lens.	78
Electronic Color Convergence (ECC).	79
Electronically adjusting convergence.	79
Disabling geometry correction.	80
Creating a source file.	81
Editing source file settings.	81
Copying existing source file settings to a new source file.	81
Deleting a source file.	81

Creating a screen file.	82
Editing screen file settings.	82
Copying existing screen file settings to a new screen file.	82
Deleting a screen file.	82
Activating a warp file.	83
Adjusting the image.	84
Correcting vignetting.	84
Correcting keystone effect.	84
Using 2D keystone correction.	85
Masking the screen edges.	85
Test patterns.	87
Displaying a test pattern.	87
Turning off a test pattern.	87
Importing a test pattern.	88
Deleting a test pattern.	88
Keeping on the test pattern.	88
Working with the scheduler.	89
Scheduling automation.	89
Editing a scheduled event.	89
Copying and pasting an existing scheduled event.	90
Copying and pasting scheduled events for an entire day.	90
Cutting and pasting a scheduled event.	90
Deleting a scheduled event.	91
Deleting scheduled events for an entire day.	91
Changing the day of the week the scheduler starts.	91
Turning off the scheduler.	91
Automation.	92
Available macro actions.	92
Fire alarm macro.	93
Christie ACT actions.	93
JNIOR actions.	94
Dolby cinema processor actions.	94
SKA-3D actions.	95
Creating a macro.	95
Running a macro.	96

Adding an action item to an existing macro. 96

Adding a macro to an existing macro. 96

Renaming an existing macro. 96

Deleting a macro. 97

Enabling press and hold function. 97

Adding an automation device to your auditorium. 97

Disabling automation warnings. 98

Modifying automation device settings. 98

Removing an automation device from your auditorium. 98

Creating, editing, and deleting playlist triggers. 99

 Creating a new global trigger. 99

 Editing existing global trigger settings. 99

 Deleting a global trigger. 99

Importing a device library. 99

 Viewing a device library. 100

 Deleting a device library. 100

Rental mode. 101

 Applying a rental mode license file. 101

 Viewing rental mode license expiry. 101

Backing up, restoring, and upgrading files. 103

 Creating a new backup file. 103

 Downloading a backup file. 103

 Importing a backup file. 103

 Sorting backup files by name and date created. 104

 Deleting a backup file. 104

 Restoring settings from a backup file. 104

 Restoring factory default settings. 104

 Upgrading the projector software. 104

Accessing projector diagnostics. 106

 Retrieving and downloading system logs. 106

 Running the projector interrogator. 106

 Viewing laser diagnostic information. 107

 Downloading a certificate. 107

Regulatory. 108

 Safety. 108

Electro-magnetic compatibility.	108
Emissions.	108
Immunity.	108
Environmental.	109

Important safety guidelines

Learn about the safety precautions related to the Christie CineLife+ projector. This projector is intended for use in a cinema environment.

General safety precautions

Read all safety and warning guidelines before installing or operating the projector.



Warning! If not avoided, the following could result in death or serious injury.

- TRIP OR FIRE HAZARD! Position all cables where they cannot contact hot surfaces, be pulled, be tripped over, or damaged by persons walking on or objects rolling over the cables.
- This product must be installed within a restricted access location not accessible by the general public.
- Only personnel who are trained on the precautions for the restricted access location can be granted entry to the area.
- Install the product so users and the audience cannot enter the restricted area at eye level.
- ELECTRICAL and BURN HAZARD! Use caution when accessing internal components. Wait for the product to cool down before accessing the internal components for installation, service, or performing optical adjustments.
- High leakage current present when connected to IT power systems.
- FIRE AND SHOCK HAZARD! Use only the attachments, accessories, tools, and replacement parts specified by Christie.
- FIRE HAZARD! Do not use a power cord, harness, or cable that appears damaged.
- Lift equipment must be used to position the product.
- Do not install or operate the projector in any position that does not meet the stated product specifications for alignment and orientation.



Caution! If not avoided, the following could result in minor or moderate injury.

- Only Christie qualified technicians are permitted to open product enclosures.

AC power precautions

Read all safety and warning guidelines before connecting to AC power.



Warning! If not avoided, the following could result in death or serious injury.

- SHOCK HAZARD! Only use the AC power cord provided with the product or recommended by Christie.
- FIRE AND SHOCK HAZARD! Do not attempt operation unless the power cord, power socket, and power plug meet the appropriate local rating standards.
- SHOCK HAZARD! Do not attempt operation if the AC supply is not within the specified voltage and current, as specified on the license label.
- SHOCK HAZARD! The UPS power cord must be inserted into an outlet with grounding.
- SHOCK HAZARD! Disconnect the product from AC before installing, moving, servicing, cleaning, removing components, or opening any enclosure.
- Install the product near an easily accessible AC receptacle.



Caution! If not avoided, the following could result in minor or moderate injury.

- FIRE HAZARD! Do not use a power cord, harness, or cable that appears damaged.
- FIRE OR SHOCK HAZARD! Do not overload power outlets and extension cords.
- SHOCK HAZARD! Power supply uses double pole/neutral fusing.

Laser safety precautions

Read all safety and warning guidelines before operating the projector laser.



Warning! If not avoided, the following could result in death or serious injury.

- Do not operate the cinema projector without all of its covers in place.
- LASER RADIATION HAZARD! This projector has a built-in Class 4 laser module. Never attempt to disassemble or modify the laser module.
- Do not look directly into the lens when the light source is on. The extreme high brightness can cause permanent eye damage.
- Possible hazardous optical radiation emitted from this product. (Risk group 3)

Lamp safety precautions

Read all safety and warning guidelines before installing the projector lamp.



Warning! If not avoided, the following could result in death or serious injury.

- This procedure must be performed by Christie qualified technicians.
- EXPLOSION HAZARD! Always wear protective safety clothing (gloves, jacket, face shield) approved by the manufacturer whenever the lamp door is open or when handling the lamp. Any local or federal specifications take precedence over Christie's protective clothing recommendations.
- Do not open the lamp door while the lamp is on.
- EXPLOSION HAZARD! Allow sufficient time for the lamp to cool down before powering down the product, disconnecting it from AC, and opening the lamp door.
- EXPLOSION HAZARD! Do not stress the glass of a lamp or bare bulb in any way.
- EXPLOSION HAZARD! Lamps and bare bulbs, even when packaged, may explode if dropped or mishandled.
- EXPLOSION HAZARD! Handle a lamp by the cathode and anode end shafts only. Do not handle the lamp by the glass.
- EXPLOSION HAZARD! Do not over-tighten the lamp.
- Do not look directly into the lens when the light source is on. The extreme high brightness can cause permanent eye damage.
- FIRE HAZARD! Keep hands, clothes, and all combustible material away from the concentrated light beam of the projector.



Caution! If not avoided, the following could result in minor or moderate injury.

- Improper installation of the lamp can damage the projector.
- Incorrect lamp power supply and igniter connections can damage the product.

Light intensity hazard distance

This projector has been classified as Risk Group 3 as per the IEC 62471-5:2015 standard due to possible hazardous optical and thermal radiation being emitted.



Warning! If not avoided, the following could result in serious injury.

- PERMANENT/TEMPORARY BLINDNESS HAZARD! No direct exposure to the beam must be permitted.
- PERMANENT/TEMPORARY BLINDNESS HAZARD! Operators must control access to the beam within the hazard distance or install the product at the height that prevents exposure of spectators' eyes within the hazard distance. The hazard and no access zones are based on the type of venue the projector is installed in. For restrained environments, the hazard zone must be no lower than 2.5 meters/8.2 feet (US installations) or 2.0 meters/6.6 feet (global installations) above any surface upon which any persons are permitted to stand and the horizontal clearance to the hazard zone must be a minimum 1.0 meters (3.3 feet). For unrestrained environments, the hazard zone must be no lower than 3.0 meters (9.8 feet) above the floor and the horizontal clearance to the hazard zone must be a minimum 2.5 meters (8.2 feet).
- EXTREME BRIGHTNESS! Do not place reflective objects in the product light path.

The following show the zones for ocular and skin hazard distances.

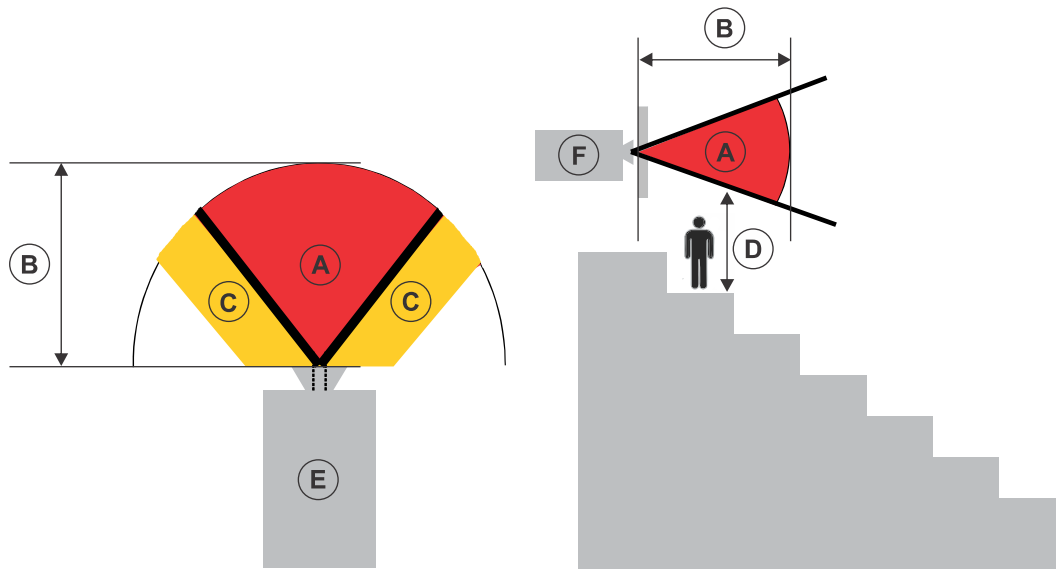

- A—Hazard zone. The region of space where the projection light from the projector is above emission limits for Risk Group 2. The light intensity may cause eye damage after a momentary or brief exposure (before a person can avert their eyes away from the light source). The light may cause skin burns to occur.
- B—Hazard distance. Operators must control access to the beam within the hazard distance or install the product preventing potential exposure of the spectators' eyes from being in the hazard distance.
- C—No access zone. The no access zone must be followed based on the type of venue the projector is installed in.
 - For restrained environments like theaters and facilities where the audience is controlled with formal structures, supervision, or physical constraints, the no access zone must be no less than 1.0 meters (3.3 feet).
 - For unrestrained environments like a concert venue or facility that has actions by individuals that are not controlled or guided by formal structures, supervision, or physical constraints and therefore may include unexpected actions that increase the likelihood of accidental hazardous exposure to optical radiation, the no access zone must be no less than 2.5 meters (8.2 feet).
- D—Vertical distance to hazard zone. The hazard zone above the floor must be followed based on the type of venue the projector is installed in.
 - For restrained environments like theaters and facilities where the audience is controlled with formal structures, supervision, or physical constraints, the hazard zone must be no lower than 2.5 meters/8.2 feet (US installations) or 2.0 meters/6.6 feet (global installations) above any surface upon which any persons are permitted to stand.
 - For unrestrained environments like a concert venue or facility that has actions by individuals that are not controlled or guided by formal structures, supervision, or physical constraints and therefore may include unexpected actions that increase the likelihood of accidental hazardous exposure to optical radiation, the hazard zone must be no lower than 3.0 meters (9.8 feet) above the floor.

If the vertical distance to hazard zone requirement (Zone D) is satisfied, the horizontal clearance distance (Zone C) is not needed.

- E—Represents the top view of the projector.

- F—Represents the side view of the projector.

For information detailing the hazard distance for each lens, refer to the product's *Installation and Setup guide*.

For Installations in the United States

The following must be in place for laser-illuminated projector installations in the United States:

- The projection room shall be clearly identified by the posting of laser warning and restricted access signs, and by restricting entry through physical means. The projection room sign must display the warning "No direct exposure to beam shall be permitted".
- The Christie Laser Projection System Installation Checklist must be fully completed after the installation and sent to lasercompliance@christiedigital.com. A copy can remain on-site. This checklist can be found as a separate document in the accessory box with the manual.
- Certain US states have additional laser regulatory requirements. Contact lasercompliance@christiedigital.com for additional regulatory requirements.

Introduction

This manual is intended for operators of Christie CineLife+ projection systems.
For complete product documentation and technical support, go to www.christiedigital.com.

Software version

This guide is intended for use of the CineLife+™ software version 2.0 or later.
For projectors using earlier software versions, see *CineLife+ User Guide (P/N: 020-103073-XX)*.

Models

This guide applies to the following models.

- All Christie Series 4 laser projectors:
 - CP44xx-RGB
 - CP24xx-RGB
- All Christie Series 4 xenon projectors:
 - CP2415-Xe
 - CP2420-Xe
 - CP4420-Xe
- All Christie Series 4 laser plus phosphor projectors:
 - CP44xxm-RGBH

What's new in the guide?

The following updates have been made to the guide.

-06 updates

- Updated the *Models* (on page 15) list of projector formatting.
- Moved the *service mode* (on page 25) topics to the Operating the projector chapter.
- Updated *Enabling service* (on page 25) topic to include phosphor drive level wording for CP44xxm-RGBH models.
- Updated the *Determining the projector IP address* (on page 21) and *Resetting the projector IP address* (on page 22) topics to provide full wording for the ENG SW button on CP44xxm-RGBH models.
- Provided the date format options in the *Changing the date format* (on page 28) topic.

- Updated *Changing the orientation of the projected image* (on page 28) topic regarding inverted positions.
- Updated *Video Input panel* (on page 31) topic for the CAVE LP section.
- Added *3D sync connector* (on page 38) topic.
- Updated all input channel options in the *Working with channels* (on page 62) chapter.
- Updated wording regarding which test patterns cannot be deleted in the *Deleting a test pattern* (on page 88) topic.
- Removed information from *Creating a macro* (on page 95) topic as now macro names accept spaces and special characters.

-05 updates

- Added the following new topics:
 - *Software version* (on page 15)
 - *Changing the date format* (on page 28)
 - *Hibernate mode* (on page 40)
 - *Creating a new laser file for RGBH projectors* (on page 43)
 - *Custom color space conversion files* (on page 70)
 - *Enabling press and hold function* (on page 97)
 - *Disabling automation warnings* (on page 98)
- Added hibernate mode in the *Projector power modes* (on page 18) topic.
- Updated *LED status indicators* (on page 19) to include hibernate mode statuses.
- Added recommended screen resolution for *using the web user interface (web UI)* (on page 23).
- Updated *Video Input panel* (on page 31) topic to include CAVE LP + VOM CI faceplate description.
- Updated *LiteLOC™ sensor-to-screen calibration* (on page 46) chapter to distinguish workflows for different models.

Accessing product documentation

For installation, user, and service information, see the product documentation available on the Christie website. Read all instructions before installing, using, or servicing this product.

1. Access the documentation from the Christie website:
 - Go to one of the following URLs:
 - <https://bit.ly/3vxrm4Y>
 - <https://www.christiedigital.com/products/cinema/projection/cinelife-plus-series/>
 - Scan the QR code using a QR code reader app on a smartphone or tablet.



2. To access service information, sign into the Partner Portal.
3. On the product page, select the model and switch to the **Downloads** tab.

Cinema calculator tool

Use Christie's cinema calculator tool to determine the right projector, lens, and lamp based on the unique needs of your installation, as well as your preferred projector type, screen configuration, and brightness requirements.

To learn more and use the tool, go to <https://cinemaster.christiedigital.com/>.

Viewing Christie University product training videos

Christie University provides select product training videos that are helpful for understanding and using your product.

To view the available videos for your product:

1. Go to Christie University: <https://training.christiedigital.com>.
2. Select **I'm a Christie partner or customer**.
3. Log into your profile.
4. Select **Catalog**.
5. Select **Videos**.
6. Select **Product Training Videos**.
7. Navigate to the folder for your product.

Technical support

Technical support for Christie Cinema products is available at:

- Support.cinema@christiedigital.com
- +1-877-334-4267

Operating the projector

Learn how to operate the projector and adjust projector settings.

Projector power modes

The CineLife+ projectors track laser operation hours for the laser optical subsystems (LOS) and the lamp operation hours for xenon lamps.

The projector operates with the following power modes:

Mode	Description
Standby	<ul style="list-style-type: none"> • CineLife+™ electronics remain on standby with the light engine off. • Fans, laser optical sub-systems (LOS) or xenon lamp, and thermo-electric cooler (TEC) devices are off. • Integrated Media Block (IMB) is off—IMB automation does not function. • Fire alarm does not function.
Standby (IMB On)	<ul style="list-style-type: none"> • CineLife+™ electronics and the IMB are powered on with the light engine off. • Power is available to the optional touch panel and laser optical sub-systems (LOS). • Power is available to the thermo-electric cooler (TEC) devices; however, the drivers are disabled. • Some fans are low speed (depending on projector type). • Pumps are off. • Chiller is off (if applicable). <p>This mode is set from Service Setup > Preferences > IMB.</p>
Hibernate	<p>Only applies to: CP44xxm-RGBH projectors</p> <ul style="list-style-type: none"> • Ethernet PHY for Wake On LAN (WOL) magic packet and Hibernate Interface switch powered and enabled. • Other parts of the projector are off.
Projector on	<ul style="list-style-type: none"> • CineLife+™ electronics and light engine are on. • LOS and TEC devices are off. • Chiller is on (CP4440-RGB, CP4445-RGB, CP4450-RGB, and CP4455-RGB projectors only). • IMB is on.
Light source on	<ul style="list-style-type: none"> • CineLife+™ electronics and light engine are on. • LOS and TEC devices are on.

Mode	Description
	<ul style="list-style-type: none"> • Fans run at full speed. • Chiller is on (CP4440-RGB, CP4445-RGB, CP4450-RGB, and CP4455-RGB projectors only). • IMB is on.

System operation for CP4440-RGB, CP4445-RGB, CP4450-RGB, and CP4455-RGB projectors only

Understand the correct sequence for powering up and operating CP4440-RGB, CP4445-RGB, CP4450-RGB, and CP4455-RGB systems.

The connected chiller must always be turned on first and turned off only after the projector is turned off. Once the chiller is connected to AC and the chiller communication cable is connected to the projector, the projector controls the chiller automatically to maintain the required coolant temperature.



Christie recommends powering on the projector 30 minutes before use to allow time for the chiller to set the coolant to the set temperature.

The system is ready to operate when the following steps are completed:

1. The connected chiller unit is powered on.
2. The projector's main power switches are on.
3. Communication between the projector and the connected chiller is confirmed and coolant temperatures are correctly maintained.

If a thermal shutdown occurs in a dual projector installation, verify the chiller communication cables are connected correctly between each projector-chiller pair. This makes sure no cross-connection exists relative to the coolant lines.

Turning on or off the projector

Turn on the projector to display content or turn off the projector to conserve energy or service the projector.

In the right toolbar, select and hold **Power**. 

LED status indicators

Red, yellow, blue, and green LEDs on the top and rear corners of the projector indicate the status of the projector.

This following table provides the status indicator LED action and its meaning. The LEDs can be solidly lit, flash frequently, or flash intermittently.

LED action	Projector state	Description
Solid green	Power on	Power is on, light source is on.
Flashing green one time per second	Standby mode	Power is off, light source is off. Power saving mode.
Solid blue	Hibernate mode	Hibernate mode is on, power and light source are off. Power saving mode.
Flashing blue one time per second	Boot-up mode	Projector is booting up when waking up from Hibernate mode.
Flashing green three times per second	Warming up mode	Projector is warming up.
Flashing green and yellow	Cool-down mode	Power is on, light source is off. The light source can be turned on when in this mode.
Flashing yellow	Warning	Warning exists but has not been acknowledged by the operator.
Flashing red	New critical alarm or warning	New critical alarm or warning has not been acknowledged by the operator.
Solid red	Existing critical alarm or warning	Critical alarm or warning exists but has been acknowledged by the operator.

Logging into the projector

Log into the projector to access projector menus.

1. From the login page, in the User list, select a username.
2. Enter your password.
3. Select **Login**.

Logging out of the projector

Log out of the projector to restrict access to projector menus or to change access permissions.

- Select **Logout**.

Changing the session timeout

Session Timeout automatically logs a user out after a pre-determined duration of inactivity when using the Touch Panel Control or the Web User Interface (UI).

1. In the navigation menu, select **Service Setup**.
2. Select **Preferences**.
3. Select **General**.

4. In the System area, select Session Timeout duration:
 - 30 minutes—this is the default duration for Web UI.
 - 1 hour
 - 2 hours
 - 5 hours
 - 12 hours—this is only available for Web UI.
 - Never—this is only available for the Touch Panel Control and is the default.

Determining the projector IP address

Before accessing the projector user interface remotely, determine the IP address of the projector. Use the following method to determine the projector IP address when no touch panel is installed.

1. Connect the projector to the theater network using an Ethernet cable.
2. Make sure the projector is not in Standby mode:
 - For CP44xx-RGB, CP24xx-RGB, CP24xx-Xe, and CP44xx-Xe models, select the recessed button between the USB-C port and the USB port on the Video Input panel. Pressing the recessed button transitions the projector from Standby to powered on.

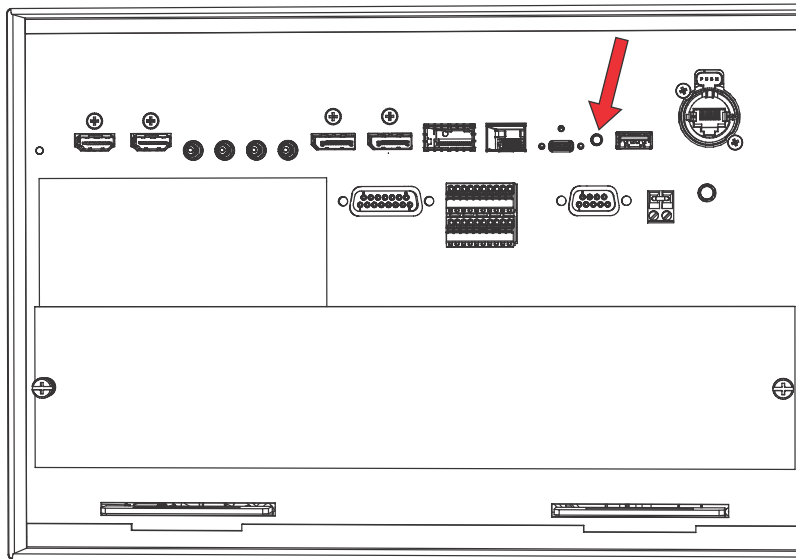

- For CP44xxm-RGBH models, select the ENG SW button located between the Hibernate port and USB-C port on the Video Input panel. Pressing the ENG SW button transitions the projector from Standby to powered on.

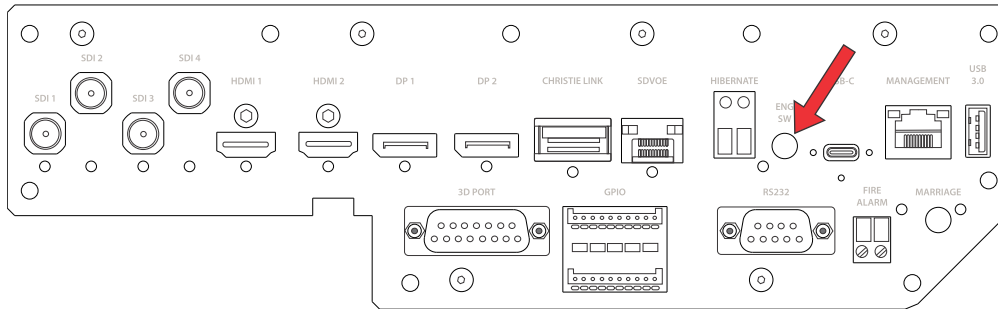

3. Make sure the path in front of the lens is clear and ready for the IP address to be projected as continuing to step 4 turns on the light source and projects the IP address on the screen.
4. Once the unit is powered on, select and hold the **Marriage** button on the projector for 5 to 25 seconds.
 The projector turns on the light source and displays a test pattern with the projector's IP address and any currently active alarms.
 The light source remains on.
5. To turn the light source off, select and hold the **Marriage** button for 5 to 25 seconds.

Resetting the projector IP address to the default

Use the following method to reset the projector IP address to the default value (192.168.206.110) and the subnet is 255.255.255.0 when no touch panel is installed.

1. Connect the projector to the theater network using an Ethernet cable.
2. Make sure the projector is not in Standby mode:
 - For CP44xx-RGB, CP24xx-RGB, CP24xx-Xe, and CP44xx-Xe models, select the recessed button between the USB-C port and the USB port on the Video Input panel.
 Pressing the recessed button transitions the projector from Standby to powered on.

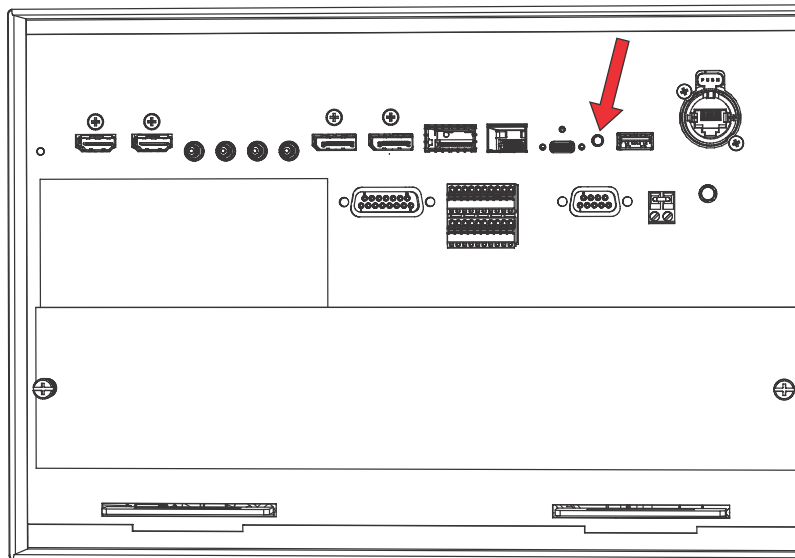

Before resetting the IP address to factory default, the light source turns on and remains on. The IP address is shown as described in *Determining the projector IP address* (on page 21).

- For CP44xxm-RGBH models, select the ENG SW button located between the Hibernate port and USB-C port on the Video Input panel.

Pressing the ENG SW button transitions the projector from Standby to powered on.

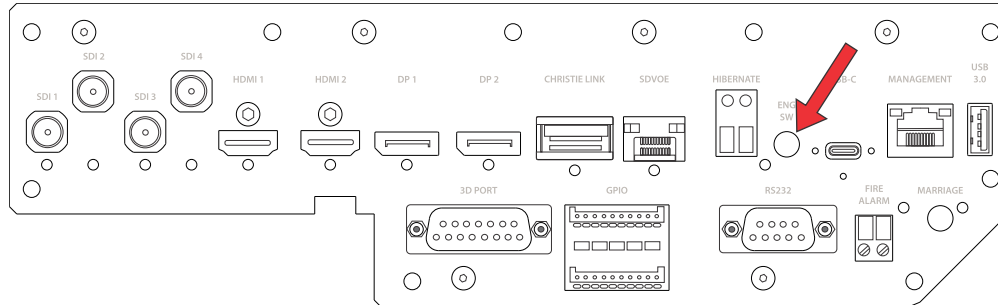

Before resetting the IP address to factory default, the light source turns on and remains on. The IP address is shown as described in *Determining the projector IP address* (on page 21).

3. Once the unit is powered on, select and hold the **Marriage** button on the projector for 30 seconds.
The IP address of the projector is reset to the default.
4. Once you have reset the IP address, turn off the light source by selecting and holding the **Marriage** button for 5 to 25 seconds.

Using the web user interface (Web UI)

Use a web browser to use the web user interface (Web UI) to access projector functionality.



For optimal web user interface viewing, Christie recommends using a screen resolution of 1280 x 800 or higher, preferably with a widescreen aspect ratio such as 16:9 or 16:10.

1. In a web browser, enter the IP address of the projector.
The default IP address is 192.168.206.110.
2. Log into the Web UI.
3. To access the projector menu, select the left navigation menu.
4. To upload or download files from the projector, navigate to the feature.
5. If the projector has a GDC IMB SR-1000 installed and configured, access the GDC IMB Web UI by navigating to the left navigation menu and selecting **IMB**.

Turning on or off the touch panel

Turn on the touch panel to view projector menus, or turn off the touch panel to conserve energy.

- To turn on or off the touch panel, select the **Power** button  (A) on the top of the touch panel.

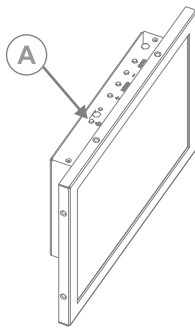

Understanding the Christie touch panel interface and web user interface

Use the touch panel or web UI to control the projector and perform functions such as turning on or off the light, selecting channels, and viewing status information.



If no touch panel is installed, use the web UI feature. See *Using the web user interface (Web UI)* (on page 23).

By default, the menu is not displayed. To access the menu, select the left navigation menu.

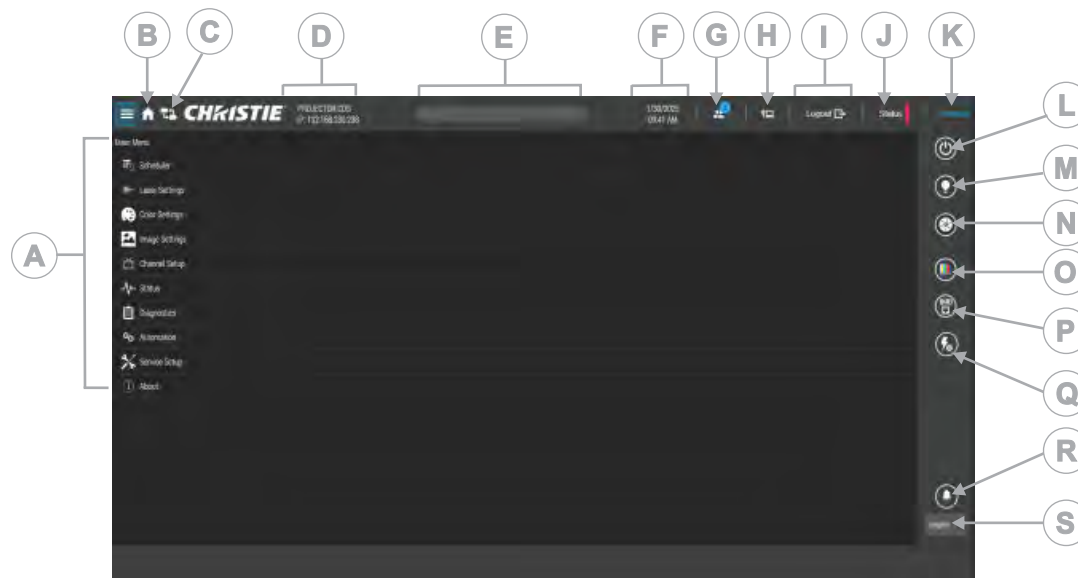

A	Left navigation menu Access permissions determine the available options.	K	Current access permissions
B	Dashboard Displays default dashboard. The dashboard displays Upcoming Events, Status, and Alarms (and Scheduler toggle).	L	Power Turns the projector on or off.
C	Discover	M	Light Turns the light on or off.

	Provides a list of projectors on the same network. This is only available on the web UI.		
D	Projector name and IP address	N	Douser Opens and closes the shutter.
E	Search bar	O	Test Patterns Turns test patterns on or off.
F	Current date and time	P	All Channels Displays channels.
G	Active users Displays how many users are logged into the projector.	Q	Macro Selection Displays automation macros.
H	Network connection status	R	Notification history
I	Logout	S	Language Displays current language preference.
J	System status To display all alarms, select the colored icon.	—	—

Enabling service mode

Service mode limits the laser power to a user-defined lower power for use when performing optical alignment.

When the maximum drive level values are set, they are maintained during a reboot. The drive levels reset when disabling service mode or performing a backup or restore.

1. Log in as service.
2. In the left navigation menu, select **Service Setup > Preferences**.
3. Select **Service Mode**.
4. To enable laser service mode, toggle on **Enable Service Mode**.
5. In the Warning dialog, to edit the maximum drive laser levels, select **Enable**.
The default levels are set to 0.
6. Enter the individual maximum drive levels for red, green, and blue.
For CP44xxm-RGBH models, enter the individual maximum drive levels for red, green, blue and phosphor.
Message appears in bottom right corner when the change is successful. Status warning displays updated entry for each LOS Drive Limit with the updated drive limit values.

Disabling service mode

Restore the maximum drive laser levels to the original values.

1. In the left navigation menu, select **Service Setup > Preferences**.

2. Select **Service Mode**.
3. To disable laser service mode, toggle off **Enable Service Mode**.
4. In the Warning dialog, verify the projector is safe to operate at full brightness without restriction.
5. Select **Disable**.
All maximum driver levels restore to 0. Status page displays LOS Drive Limits as *Disabled*.

Turning on the light source with service mode enabled

When service mode is enabled, LiteLOC™ is disabled.

Service role level is required to perform this procedure.

1. Turn on the light source.
2. In the Warning dialog, verify the requirements are met.
3. If requirements are met, select **Continue**.
4. If requirements are not met, select **Cancel**.
5. Select **Manual Laser Control**.
6. To enable the white display test pattern, toggle on **Display White Test Pattern**.
The RGB maximum limits are the same as the values defined in the service mode setup.
7. To restore the values to the original, disable service mode.

Turning on or off the light source

Turn on the light source to display content or view test patterns. Turn off the light to extend the life of the light source.

- To turn on or off the light source, in the right toolbar, select and hold **Light**. 

If turning on the light source when the projector power is off, power is turned on automatically.



- For laser projector models, allow the projector to cool down for 3 minutes after turning it off.
- For xenon projector models, allow the projector to cool down for 10 minutes after turning it off.



If you turn on the laser source while the projector is cooling down, the lasers turn on.

Opening or closing the shutter

Open the shutter (douser) to display light on the screen, or close the shutter to remove light from the screen.

1. In the right toolbar, select and hold **Douser**. 
 - If the shutter was closed, the shutter opens. 
 - If the shutter was open, the shutter closes. 

The shutter sensor prevents light source activation when the shutter is closed.

2. If the shutter is not functioning, use the **Permit light source activation when shutter is nonfunctional** option to permit activation of the light source.

To enable this option, select **Service Setup > Preferences > Lens/ILS** and enable **Permit light source activation when shutter is nonfunctional**.

To avoid damage to the projector, only enable this option when the shutter can be verified as open.

Adding a network time protocol server

Add a network time protocol (NTP) server to synchronize the time on all installed projectors in the same region.

1. In the left navigation menu, select **Service Setup > Time Setup**.
2. Switch to the **Projector Time Settings** tab.
3. Select **Sync to NTP Server**.
4. Select **New NTP Server**.
5. In the Add New NTP Server dialog, select a local or a public NTP server:
 - To use a local NTP server, select **Local Server** and enter the IP address in the IP Address field.
 - To use a public NTP server, select **Public Server** and complete the Country and Server fields.
6. To test the connection, select **Test**.
7. Select **Add**.

Deleting a network time protocol server

Remove a network time protocol (NTP) server if you do not need to synchronize the time on all installed projectors in the same region.

1. In the left navigation menu, select **Service Setup > Time Setup**.
2. Switch to the **Projector Time Settings** tab.
3. Select **Sync to NTP Server**.
4. In the NTP Server Address list, select an NTP server.
5. Select **Delete**. 
6. At the confirmation dialog, select **Delete**.

Changing the time zone

Change the time zone settings to make the projector time match the local time zone.

1. In the left navigation menu, select **Service Setup > Time Setup**.
2. Select **Time Zone**.

3. In the Region list, select a region.
4. In the Time Zone list, select the time zone.
5. To automatically adjust the projector time to follow Daylight Saving Time, select **Automatically adjust for Daylight Saving Time**.
The color of the slider changes to green to indicate it is active.
6. Select **Save**.

Changing the time format

You can use the 12-hour or 24-hour format to display projector time. The 24-hour format reduces ambiguity.

1. In the left navigation menu, select **Service Setup > Preferences**.
2. Select **General**.
3. In the System area, select a time format option:
 - To use the 12-hour format, select **12 Hours**.
 - To use the 24-hour format, select **24 Hours**.

Changing the date format

Select the preferred date format to display in the user interface.



1. In the left navigation menu, select **Service Setup > Preferences**.
2. Select **General**.
3. In the System area, select a date format option:
 - MM/DD/YYYY
 - DD/MM/YYYY
 - YYYY-MM-DD

Changing the orientation of the projected image

Change the orientation of the projected image from normal to inverted to support multi-projector installations where deflection mirrors are used.

1. In the left navigation menu, select **Service Setup > Preferences**.
2. Select **General**.
3. From the Projected Image Orientation list, select the required orientation for the projected image.

Orientation	Description
Normal Front	Projection from behind the audience with the projector in the normal, upright position.
Inverted Front	Projection from behind the audience with the projector in an inverted position (upside down).

Orientation	Description
	 <p>Inverted positioning is not supported for all CineLife+ projectors. For more information, see the Installation and Setup guide for your projector model.</p>
Normal Rear	Projection from behind the screen with the projector in the normal, upright position.
Inverted Rear	<p>Projection from behind the screen with the projector in an inverted position (upside down).</p>  <p>Inverted positioning is not supported for all CineLife+ projectors. For more information, see the Installation and Setup guide for your projector model.</p>

Changing the projector hostname

Change the projector hostname to make it easier to identify.

1. In the left navigation menu, select **Service Setup** > **Preferences**.
2. Select **General**.
3. In the Projector Hostname field, enter a name.
4. Select **Update**.

The projector hostname is displayed above the IP address at the top of the screen.

Changing the temperature display

Set the touch panel to display temperatures in Celsius or Fahrenheit degrees.

1. In the left navigation menu, select **Service Setup** > **Preferences**.
2. Select **General**.
3. In the Temperature Units list, select **Celsius** or **Fahrenheit**.

Disabling serial authentication requirement

By default, Require Serial Authentication is turned on. If Require Serial Authentication is not required, you can manually disable this feature.

1. In the left navigation menu, select **Service Setup** > **Preferences**.
2. Select **Automation**.
3. To disable serial authentication requirement, toggle off **Require Serial Authentication**.

Viewing system status information

View alarms, warnings, and errors of the Christie CineLife+.

1. In the top right of the dashboard, select **Status**.

You can also select **Status** from the left navigation menu.

2. Navigate to the status category you want to view and select it.

Video Input panel

The Video Input panel, located on the projector side input panel (operator side), has a variety of ports that can supply alternative video content to the projector.

CAVE Video Input panel

Only applies to: CP2415-RGB, CP2420-RGB, CP4415-RGB, CP4420-RGB, CP4425-RGB, CP4430-RGB, CP4435-RGB, CP4440-RGB, CP4445-RGB, CP4450-RGB, CP4455-RGB, CP2415-Xe, CP2420-Xe, CP4420-Xe

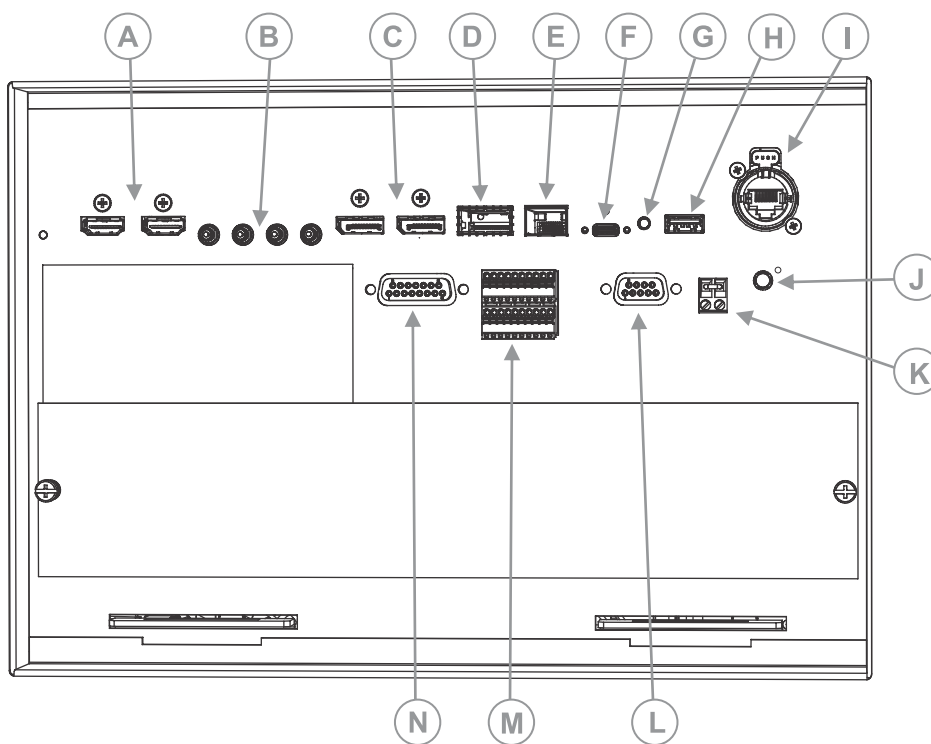

ID	Port	Description
A	HDMI input 1 and HDMI input 2	Type A connector Accepts digital video data from HDMI v2.0 input supporting EDID 1.3 with HDCP v1.4 and 2.2 support.
B	SDI input 1, SDI input 2, SDI input 3, and SDI input 4	75 ohm Micro-BNC Connector Multi-Rate SDI in accordance with SMPTE ST 259 (270 Mb/s), ST 292-1 (1.5 Gb/s), ST 424 (3.0 Gb/s), ST 2081-1 (6 Gb/s) and ST 2082-1 (12 Gb/s)
C	DisplayPort (DP1 and DP2)	Accepts digital video data from DisplayPort 1.2 input supporting EDID 1.3 with HDCP 1.3 support.

ID	Port	Description
D	Christie Link port	Not used.
E	Software-Defined Video over Ethernet (SDVoE) port	Not used.
F	USB-C port	Connects the projector touch panel.
G	Recessed button	Select the button to transition the projector from Standby mode to Power ON mode.
H	USB port	Connects to external memory device for import and export of projector software, configuration files, and status information.
I	Management port	Connects to the local network and can send CineLife+™ serial commands and used for Web UI access.
J	Marriage button	<p>Used during the Integrated Media Block (IMB) marriage setup process.</p> <ul style="list-style-type: none"> • Select and hold the button for 5 seconds to display the IP address and status information. • Select and hold the button for 30 seconds to reset the IP address to the default address. <p>The marriage status LED indicator is located to the right of the Marriage button. In full power mode, a green LED indicates the projector is properly married and encrypted content can be displayed. A red LED indicates marriage is broken and encrypted content cannot be displayed.</p>
K	Fire alarm connection	Connects to the Theater Fire Management system for automatic shut down in emergency situations.
L	RS232 communication port	Not used.
M	GPIO port	Connects the projector to external automation or automation devices.
N	3D sync connector	Connects the projector to 3D devices.

CAVE LP Video Input panel

Only applies to: CP2415-RGB, CP2420-RGB, CP4415-RGB, CP4420-RGB, CP4425-RGB, CP4430-RGB, CP4435-RGB, CP4440-RGB, CP4445-RGB, CP4450-RGB, CP4455-RGB, CP4410m-RGBH, CP4415m-RGBH, CP4420m-RGBH

For projectors using the CAVE LP Video Input panel, the projector cannot be downgraded below version 2.4.0.

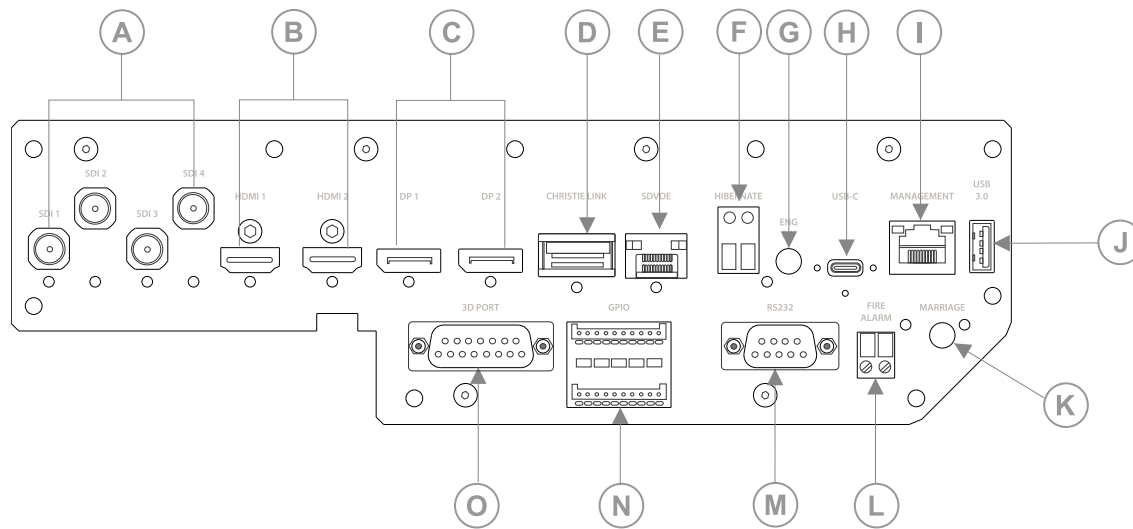

ID	Port	Description
A	SDI input 1, SDI input 2, SDI input 3, and SDI input 4	75 ohm BNC Connector Multi-Rate SDI in accordance with SMPTE ST 259 (270 Mb/s), ST 292-1 (1.5 Gb/s), ST 424 (3.0 Gb/s), ST 2081-1 (6 Gb/s) and ST 2082-1 (12 Gb/s)
B	HDMI input 1 and HDMI input 2	Type A connector Accepts digital video data from HDMI v2.0 input supporting EDID 1.3 with HDCP v1.4 and 2.2 support.
C	DisplayPort (DP1 and DP2)	Full size DisplayPort connector Accepts digital video data from DisplayPort 1.2 input supporting EDID 1.3 with HDCP 1.3 support.
D	Christie Link port	Not used.
E	Software-Defined Video over Ethernet (SDVoE) port	Not used.
F	Hibernate	Two-wire terminal block to permit the user to connect a contact switch to bring the projector out of hibernate mode.
G	ENG SW	Select the button to transition the projector from Standby mode to Power ON mode or bring the projector out of hibernate mode.
H	USB-C port	Connects the projector touch panel.
I	Management port	Connects to the local network and can send CineLife+™ serial commands and used for Web UI access.
J	USB 3.0 port	Connects to external memory device for import and export of projector software, configuration files, and status information.
K	Marriage button	Used during the Integrated Media Block (IMB) marriage setup process. <ul style="list-style-type: none"> Select and hold the button for 5 seconds to display the IP address and status information.

ID	Port	Description
		<ul style="list-style-type: none"> Select and hold the button for 30 seconds to reset the IP address to the default address. <p>The marriage status LED indicator is located to the right of the Marriage button. In full power mode, a green LED indicates the projector is properly married and encrypted content can be displayed. A red LED indicates marriage is broken and encrypted content cannot be displayed.</p>
L	Fire alarm connection	Connects to the Theater Fire Management system for automatic shut down in emergency situations.
M	RS232 communication port	Not used.
N	GPIO port	Connects the projector to external automation or automation devices.
O	3D sync connector	15-pin Subminiature D-Type, Female Proprietary 3D communication protocol with combined RS 232-C and GPIO communication. Used for controlling external active and passive 3D polarization systems and glasses.

HDMI video source

For the projector to accept digital video data from HDMI sources, plug the HDMI source directly into the Video Input panel.

The input configurations listed below are supported.

Input configuration	Description
Single-input	Accepts connection of one HDMI cable. Supports both 2D and 3D frame-packed, top and bottom. In this configuration, the HDMI input supplies the entire video raster.
Dual-input	Enables connection of two HDMI cables in support of 3D LR, where HDMI Input 1 = left eye and HDMI Input 2 = right eye.

For supported video formats for your projector model, see *CineLife+ Supported Video Formats technical reference (P/N: 020-104085-XX)*.

SDI video source

For the projector to accept digital video data from 12G, 6G, 3G, or HD/SD SDI video source, plug the source directly into the Video Input panel.

The input configurations listed below are supported.

Input configuration	Description
Single-link	Accepts connection of 12G, 6G, 3G, and HD/SD SDI input standards.
Dual-link	Accepts connection of dual-link 6G, 3G, and HD SDI input standards.
Quad-link	Accepts connection of quad-link (2SI) 6G or 3G SDI input standards. Accepts connection of quad-link (SQ div) 6G, 3G, or 1.5G SDI input standards.

For supported video formats for your projector model, see *CineLife+ Supported Video Formats technical reference (P/N: 020-104085-XX)*.

DisplayPort video source

For the projector to accept digital video data, plug the DisplayPort source directly into the Video Input panel.

The input configurations listed below are supported.

Input configuration	Description
Single-input	Enables connection of one DisplayPort cable. Supports both 2D and 3D frame sequential transmission format. In this configuration the DisplayPort input supplies the entire video raster.
Dual-input	Enables connection of two DisplayPort cables. Supports both 2D and 3D frame sequential transmission format.

For supported video formats for your projector model, see *CineLife+ Supported Video Formats technical reference (P/N: 020-104085-XX)*.

Integrated Media Block (IMB) video source

Christie Series 4 projectors support both the legacy Series 2 (S2) and newer Series 4 (S4) HDRConnect™ IMB interfaces to send digital video data from an IMB to the projector.

Contact Christie Technical Support to learn which S2 and S4 IMB devices are compatible with Christie projectors.

For supported video formats for your projector model, see *CineLife+ Supported Video Formats technical reference (P/N: 020-104085-XX)*.

HDMI video source connection from an Integrated Media Block (IMB)

The projector can accept digital video data from HDMI sources connected to applicable Integrated Media Block (IMB) devices. The input configurations supported are determined by the IMB device directly.

Contact Christie Technical Support to learn which IMB devices provide HDMI source selection from the projector user interface.

HDMI input selection directly from the IMB may also be possible using the IMB user interface. The input configurations supported are determined by the IMB make and model.

SDI video source connection from an Integrated Media Block (IMB)

The projector can accept digital video data from SDI sources connected to applicable Integrated Media Block (IMB) devices.

The input configurations supported are determined by the IMB device directly. Contact Christie Technical Support to learn which IMB devices provide SDI source selection from the projector user interface.

SDI input selection directly from the IMB may also be possible using the IMB user interface. The input configurations supported are determined by the IMB make and model.

GPIO connector

The General Purpose Input Output (GPIO) connector provides a flexible method of interfacing with the projector. Two pins are reserved for ground and power.

The GPIO connector is located on the input panel (*M* in the CAVE Video Input panel image and *N* in the CAVE LP Video Input panel image (on page 31)).

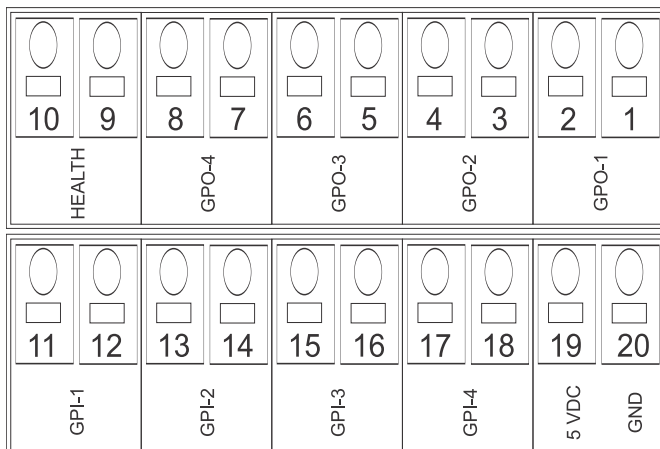

Pin number	Signal name	Direction
Pin 1	GPO1_POS	Out
Pin 2	GPO1_NEG	Out
Pin 3	GPO2_POS	Out
Pin 4	GPO2_NEG	Out
Pin 5	GPO3_POS	Out
Pin 6	GPO3_NEG	Out
Pin 7	GPO4_POS	Out
Pin 8	GPO4_NEG	Out
Pin 9	HEALTH_POS	Out
Pin 10	HEALTH_NEG	Out

Pin number	Signal name	Direction
Pin 11	GPI1_POS	In
Pin 12	GPI1_NEG	In
Pin 13	GPI2_POS	In
Pin 14	GPI2_NEG	In
Pin 15	GPI3_POS	In
Pin 16	GPI3_NEG	In
Pin 17	GPI4_POS	In
Pin 18	GPI4_NEG	In
Pin 19	+5V_ISO	—
Pin 20	GND_ISO	—

GPIO power

The +5 V_{ISO} (pin 19) provides an isolated +5 V power source, referenced to the GND_{ISO} (pin 20), and can supply up to 150 mA. This isolated power is intended to supply user circuits connected to the GPIO inputs and outputs.

GPIO inputs

The voltage and input current values applied across _POS and _NEG depend on the following input states:

- ON state (Logic '1')—The voltage range is 2 to 40 V with an input current up to 3.5 mA.
- OFF state (Logic '0')—The voltage range is less than 1 V with an input current range of less than 100 µA.

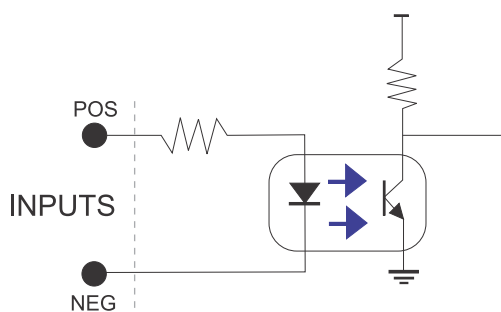

GPIO outputs

The voltage, output current, and sink values applied to _POS and _NEG depend on the following output states:

- ON state—The voltage range is less than 0.5 V with the output sink up to 1 A.
- OFF state—The voltage range is up to 25 V with an output current of less than 0.1 mA.

The negative polarity current is less than 1 A.

The minimum ON/OFF period is 1 ms.

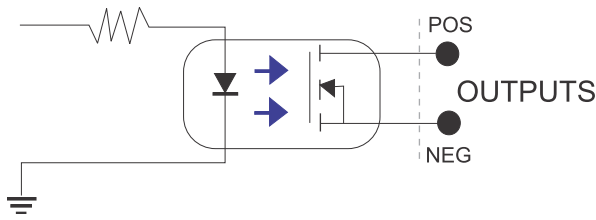

3D sync connector

The 3D sync connector provides a flexible method of interfacing with the projector.

Eleven pins are available on the 3D sync connector port. Two pins are reserved for ground, and two pins are reserved for power to the 3D device. All *_P* and *_N* signal pairs are galvanically isolated from ground (GND)/projector chassis as well as from other pairs.

The 3D sync connector is located on the input panel (*N in the CAVE Video Input panel image and O in the CAVE LP Video Input panel image (on page 31)*).

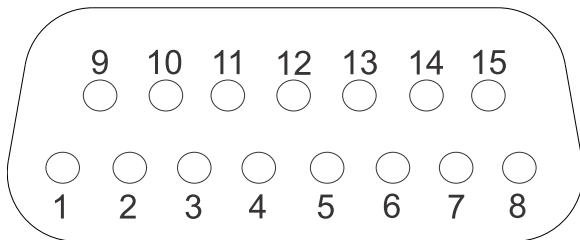

Pin number	Signal name	Direction
Pin 1	12V_3D The 12 V outputs are referenced to the GND pins (Pin 2 and Pin 3) as well as the projector chassis and is rated up to 1 A.	Out
Pin 2	GND	—
Pin 3	GND	—
Pin 4	3D_RS232_RX Signals are referenced to the GND pins (Pin 2 and Pin 3) and the projector chassis.	In
Pin 5	3D_RS232_TX Signals are referenced to the GND pins (Pin 2 and Pin 3) and the projector chassis.	Out
Pin 6	3D_MODE_P	Out
Pin 7	3D_SYNC_P	Out
Pin 8	3D_INPUT_REF_P	In
Pin 9	12V_3D	Out

Pin number	Signal name	Direction
	The 12 V outputs are referenced to the GND pins (Pin 2 and Pin 3) as well as the projector chassis and is rated up to 1 A.	
Pin 10	3D_INPUT_REF_N	In
Pin 11	3D_DISPLAY_REF_P	In
Pin 12	3D_DISPLAY_REF_N	In
Pin 13	3D_MODE_N	Out
Pin 14	3D_SYNC_N	Out
Pin 15	not connected	—

3D sync connector input

The voltage and input current values applied across _P and _N depend on the following input states:

- ON state (Logic '1')—The voltage range is 2 to 40 V with an input current range of 1.5 to 3.5 mA.
- OFF state (Logic '0')—The voltage range is 0 to 1 V with an input current range of less than 0.1 mA.

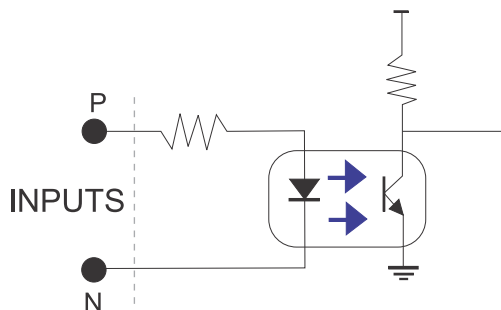

3D sync connector output

The voltage, output current, and sink values applied to _P and _N depend on the following output states:

- ON state—The voltage range is less than 1 V with the output sink up to 5 mA.
- OFF state—The voltage range is up to 25 V with an output current of less than 0.1 mA.

The minimum ON/OFF period is 80 μ s.

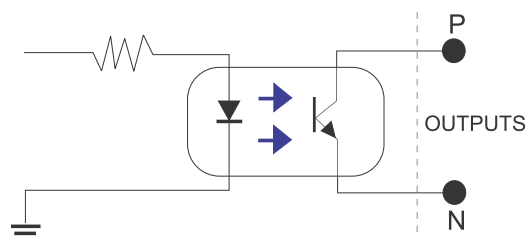

Hibernate mode

Hibernate mode achieves low standby power with restricted operational capability. Hibernate mode is disabled by default and only available through serial or Ethernet commands. **Only applies to:** CP4410m-RGBH, CP4415m-RGBH, CP4420m-RGBH

Enabling hibernate mode

Enable hibernate mode through the projector Ethernet port.

When hibernate mode is enabled, the touch panel control and web user interface are unavailable. For more information, see the *CineLife+ Serial Commands Guide (P/N: 020-103075-XX)*.

Only applies to: CP4410m-RGBH, CP4415m-RGBH, CP4420m-RGBH

1. To connect to the projector Ethernet port, change the IP address of your computer to place your computer on the same subnet as the projector.
2. Connect to the projector using port 5000 from your computer. Use a Telnet client, such as Net-Terminal, Kore Librarian, or PuTTY, to connect to the projector.
3. Log in as operator:
(UID "operator" "operator")
4. Send the following serial command:
(PWR -2)
A blue light appears underneath the Hibernate port when hibernate mode is on.

Waking up from hibernate mode

Learn how to wake up the projector from hibernate mode.

Once the projector wakes up from hibernate mode, it goes into standby mode or a pre-configured mode for initial power-on. To wake up from hibernate mode, choose one of the following methods.

Only applies to: CP4410m-RGBH, CP4415m-RGBH, CP4420m-RGBH



When starting up, a 45-second delay occurs before the projector touch panel displays the interface.

Option	Steps
ENG SW button	<ol style="list-style-type: none"> 1. Access the Video Input panel on the electronics side of the projector. 2. Press the ENG SW button located between the Hibernate port and the USB-C port .

Option	Steps
Hibernate port	<ol style="list-style-type: none"> 1. Access the Video Input panel on the electronics side of the projector. 2. Connect a relay or automation device to the Hibernate port.
Wake-on-LAN (WoL) Magic Packet program This option requires the IP address and MAC address of your projector.	<ol style="list-style-type: none"> 1. Make sure the projector is on a local subnet. 2. Open a WoL program. 3. Follow the prompts.
AC power breaker switch	<ol style="list-style-type: none"> 1. Access the rear of the projector. 2. Move the MAIN breaker switch to the OFF position. 3. Move the MAIN breaker switch to the ON position.

Managing the laser light source

Learn how to configure a laser file and use the projector's LiteLOC™ feature.

Use the laser file to control the power settings of the lasers. The LiteLOC™ feature ensures that color and brightness are held at the level you set.

Create multiple laser files to manage varying screen sizes, brightness requirements, and types of content (such as 2D, 3D, and alternative content).

For external chiller-based projectors, the laser files also contain maximum expected humidity.

Creating a new laser file for non-chiller RGB projectors

Create a laser file to store the power settings for the RGB laser light source and the maximum expected room temperature for the projection booth.

Only applies to: CP2415-RGB, CP2420-RGB, CP4415-RGB, CP4420-RGB, CP4425-RGB, CP4435-RGB

If you make significant change to the brightness level when refining the laser power settings, it takes a few minutes for the color and brightness to stabilize.

1. Log in as service.
2. Turn on the laser.
3. *Set a channel to use the appropriate calibration file (on page 62) and activate the channel (on page 67).*
4. Display a test pattern, such as DC4K 17 L Point, to locate the center of the screen.
5. Set up the color meter to aim at the center of the screen.
6. In the left navigation menu, select **Laser Settings > Laser Power/LiteLOC Setup**.
7. Select **Display White Test Pattern**.
8. To create a new laser file, select **Create**. 
9. In the Create dialog, enter a name for the new laser file and select **Create**.
10. In the White Coordinates dialog, set the required white point.
For a typical cinema setup, the white point is Digital Cinema Initiative (DCI) white $x=0.314$ and $y=0.351$.
11. Select **Apply**.
12. Adjust the brightness level until you achieve the required brightness at the specified white point.
13. If the laser file will be associated with a 3D channel, complete the following steps:

- a) Engage the 3D system in the light path by enabling **3D Sync** when selecting the test pattern.
- b) Mount a 3D glass or filter on the color meter to measure the brightness.
- c) Select **3D Sync** on the LiteLOC™ setup page.
- d) Adjust the brightness level until you achieve the required brightness while the 3D system is engaged.



14. To save the new laser file, select **Save**. 

Creating a new laser file for RGBH projectors

Create a laser file to store the power settings for the laser light source and the maximum expected room temperature for the projection booth.

Only applies to: CP4410m-RGBH, CP4415m-RGBH, CP4420m-RGBH

If you make significant change to the brightness level when refining the laser power settings, it takes a few minutes for the color and brightness to stabilize.



1. Log in as service.
2. Turn on the laser.
3. *Set a channel to use the appropriate calibration file (on page 62) and activate the channel (on page 67).*
4. Display a test pattern, such as DC4K 17 L Point, to locate the center of the screen.
5. Set up the color meter to aim at the center of the screen.
6. In the left navigation menu, select **Laser Settings > Laser Power/LiteLOC Setup**.
7. Select **Display White Test Pattern**.
8. To create a new laser file, select **Create**. 
9. In the Create dialog, enter a name for the new laser file and select **Create**.
10. Adjust the brightness level until you achieve the required brightness at the specified white point.
11. If the laser file will be associated with a 3D channel, complete the following steps:
 - a) Engage the 3D system in the light path by enabling **3D Sync** when selecting the test pattern.
 - b) Mount a 3D glass or filter on the color meter to measure the brightness.
 - c) Select **3D Sync** on the LiteLOC™ setup page.
 - d) Adjust the brightness level until you achieve the required brightness while the 3D system is engaged.
12. To save the new laser file, select **Save**. 

Creating a new laser file for external chiller-based projectors

Create a laser file to store the power settings for the RGB laser light source and the maximum expected relative humidity.

Only applies to: CP4440-RGB, CP4445-RGB, CP4450-RGB, CP4455-RGB

To make sure color and brightness are held at the required levels for your installation, enable LiteLOC™ for each laser file you create. If you make significant change to the brightness level when refining the laser power settings, it takes a few minutes for the color and brightness to stabilize.

1. Log in as service.
2. Turn on the laser.
3. *Set a channel to use the appropriate calibration file (on page 62) and activate the channel (on page 67).*
4. Display a test pattern, such as DC4K 17 L Point, to locate the center of the screen.
5. Set up the color meter to aim at the center of the screen.
6. In the left navigation menu, select **Laser Settings > Laser Power/LiteLOC Setup**.
7. Select the **Display White Test Pattern** slider.
8. To create a new laser file, select **Create**. 
9. In the Create dialog, enter a name for the new laser file and select **Create**.
10. For CP4440-RGB and CP4450-RGB models only, set the maximum expected humidity.
The projector uses this information and the ambient temperature to determine the optimum maximum brightness allowed.
11. In the White Coordinates dialog, set the required white point.
For a typical cinema setup, the white point is Digital Cinema Initiative (DCI) white $x=0.314$ and $y=0.351$.
12. Select **Apply**.
13. Adjust the brightness level until you achieve the required brightness at the specified white point.
14. If the laser file will be associated with a 3D channel, complete the following steps:
 - a) Engage the 3D system in the light path by enabling **3D Sync** when selecting the test pattern.
 - b) Mount a 3D glass or filter on the color meter to measure the brightness through the glasses.
 - c) Select **3D Sync** on the LiteLOC™ setup page.
 - d) Adjust the brightness level until you achieve the required brightness while the 3D system is engaged.
15. To save the new laser file, select **Save** .

Modifying an existing laser file

Modify the settings in the laser file to change the laser power settings or the chiller setpoint.

If you make significant change to the brightness level when refining the laser power settings, it takes a few minutes for the color and brightness to stabilize.

1. Log in as service.
2. Turn on the laser.
3. Display a test pattern, such as DC4K 17 L Point or DC2K 17 L Point, to locate the center of the screen.
4. In the left navigation menu, select **Laser Settings > Laser Power/LiteLOC Setup**.
5. To begin modifying the settings, select **Display White Test Pattern**.
6. From the Laser File list, select the laser file to edit.
7. For external chiller-based projectors only, set the maximum expected humidity.
The projector uses this information and the ambient temperature to determine the optimum Chiller set temperature.
8. For all models except CP44xxm-RGBH, in the White Coordinates dialog, set the required white point.
9. Select **Apply**.
10. Set the brightness levels as required for your projection environment and allow the projector to stabilize for a few minutes.
System stability may be affected if you set a power level below the minimum power level recommended.
11. If white or brightness is not at the target level, adjust the settings to achieve the target and allow the projector to re-stabilize for an additional three to five minutes.



The projector is considered stable when no further adjustments are required and you obtain the same screen state results after two sets of measurements, five minutes apart.

12. To save the new settings, select **Save**. 

Copying existing laser settings to a new file

Copy an existing laser file when creating a new file with similar settings.

1. In the left navigation menu, select **Laser Settings > Laser Power/LiteLOC Setup**.
2. From the Laser File list, select the file to copy.
3. To save the new laser file, select **Save As**. 
4. Enter a new name for the laser file and then select **Save**.
5. Adjust the settings as required for the new configuration.
6. Select **Save**.

Deleting a laser file

Delete a laser file when the configuration is no longer required.

1. In the left navigation menu, select **Laser Settings > Laser Power/LiteLOC Setup**.
2. In the Laser File list, select the file to delete.
3. Select **Delete**. 
4. To confirm the deletion, select **Delete**.

LiteLOC™ sensor-to-screen calibration

The LiteLOC™ sensor-to-screen calibration is performed in the factory under specific setup conditions which include the type of lens, screen, and the spectroradiometer used for measuring screen color and brightness.

Your projector's setup conditions may not match the factory setup which may result in a discrepancy in color accuracy. Upon first installation, check the accuracy of the color point and if unsatisfactory, perform this calibration. Doing this calibration captures all the variables of your setup and achieves the best results. By doing this calibration, you do not overwrite the factory calibration. Once satisfied, some scenarios may exist in which you may need to redo the calibration in the future.

Redoing this calibration is required if the following is replaced:

- Color sensor board

Christie recommends redoing this calibration if any of the following are replaced:

- Light engine
- Lens
- Light source
- Screen
- Port window
- Any other optical components in the optical path between the light source and the screen

After replacing these components, check the accuracy of the color point and if unsatisfactory, redo this calibration.

LiteLOC™ sensor-to-screen calibration: Workflow

Identify the recommended order for performing the sensor-to-screen calibration.



LiteLOC™ sensor-to-screen calibration requires the following:

- Spectroradiometer
- Service user is the minimum level user access

The following workflow applies to CP44xx-RGB and CP24xx-RGB models:

- *Create a new calibration file* (on page 47).
- *Recalibrate the calibration file* (on page 48), if required.

- *Edit the existing calibration file parameters* (on page 49) on the Sensor-to-screen menu, if required.
- *Verify the calibration* (on page 50), if required.
- *Add the calibration file to the Channel Setup* (on page 50).

The following workflow applies to CP44xxm-RGBH models:

- *Add the calibration file to the Channel Setup* (on page 50).

Creating a new calibration file

The Sensor-to-screen Calibration wizard guides you through the steps required to create a new calibration file.

Only applies to: CP44xx-RGB and CP24xx-RGB

1. Set up a spectroradiometer to obtain screen measurements later in the process.
2. In the left navigation menu, select **Color Settings > Sensor-to-screen Calibration**.
3. To create a new calibration file, select **Create** .

The projector checks if the light source is on and the douser is open. If either condition is not met, a warning dialog is displayed prompting you to make sure these conditions are met before starting the wizard.

4. In the Create dialog, enter a name for the new calibration file and select **Create**.
5. In step 1 of the Sensor-to-screen Calibration wizard, set the maximum brightness and color point.
 - a) Enable the **Display White Test Pattern** option.
 - b) Adjust the RGB sliders to set the brightness and color point.
 - c) Select **Next**.
6. Wait 20 minutes for the projector to stabilize or select **Skip** during the stabilization time period.
7. In step 2 of the Sensor-to-screen Calibration wizard, measure and enter the screen values.
 - a) To trigger the measurement at a specific operating point, under Sensor to screen, select **Capture**.

The Capture button changes color to indicate the capture process is activated. Only one Capture button is active at a time but the buttons can be selected in any order.

The projector automatically sets the red, green, and blue output laser powers to the pre-determined settings calculated and displayed in the Drive Percentage (Calculated) area of the wizard.

A 30 second countdown begins to allow the projector white point and brightness to stabilize and no changes can be made. At the end of the countdown period, the Color Sensor values fields are automatically populated by the projector for the currently selected drive percentage value.

- b) When the countdown ends, take x, y, and fL measurements using the spectroradiometer. Christie recommends taking meter readings from the center of the screen to obtain accurate screen measurements.
- c) Under Measured Values, using the numeric keypad record the associated spectroradiometer values for x, y, and fL.

- The projector holds the on-screen color and brightness level until the same or another Capture button is selected.
- d) Repeat steps a to c for the remaining drive percentage set points until all x, y, and fL values are entered.

Spectroradiometer measurements can be captured in any order but all three x, y, and fL measurements must be entered before moving onto the next capture. You can recapture a specific measurement at any time during the process by selecting the Capture button. In this case, the measured spectroradiometer and color sensor values are reset.
 - e) Once all the color sensor and measured values are entered for all rows, select **Apply and Save**.
8. Verify and complete the calibration.
- a) Select a white point to measure by selecting either the **DCI**, **D65**, or **Custom** white point buttons.

Once selected, the projector automatically enables LiteLOC™, selects a White test pattern with uncorrected colors at the white point specified, and sets the brightness to 80%.
 - b) Using a spectroradiometer, measure screen x and y values at the center of the screen.

To verify the calibration has been successfully applied, the measured white point must be within the expected tolerance.
 - c) When complete, select **Finish**.

The projector output is configured according to the currently selected calibration file and you are returned to the Sensor-to-screen Calibration menu.

Recalibrating an existing calibration file

The Sensor-to-screen Calibration wizard guides you through the steps required to re-calibrate an existing calibration file, if required.

Only applies to: CP44xx-RGB and CP24xx-RGB

1. Select **Menu > Color Settings > Sensor-to-screen Calibration**.
2. Select a user-defined calibration file to recalibrate.
3. Select **Recalibrate**.

The projector checks if the light source is on and the douser is open. If either condition is not met, a warning dialog is displayed prompting you to make sure these conditions are met before starting the wizard.
4. In step 1 of the Sensor-to-screen Calibration wizard, set the maximum brightness and color point.
 - a) Enable the **Display White Test Pattern** option.
 - b) Adjust the RGB sliders to set the brightness and color point.
 - c) Select **Next**.
5. Wait 20 minutes for the projector to stabilize or select **Skip** during the stabilization time period.
6. In step 2 of the Sensor-to-screen Calibration wizard, measure and enter the screen values.
 - a) To trigger the measurement at a specific operating point, under Sensor to screen, select **Capture**.

The Capture button changes color to indicate the capture process is activated. Only one Capture button is active at a time but the buttons can be selected in any order.

The projector automatically sets the red, green, and blue output laser powers to the pre-determined settings calculated and displayed in the Drive Percentage (Calculated) area of the wizard.

A 30 second countdown begins to allow the projector white point and brightness to stabilize and no changes can be made. At the end of the countdown period, the Color Sensor values fields are automatically populated by the projector for the currently selected drive percentage value.

- b) When the countdown ends, under Measured Values, using the numeric keypad capture and record the associated spectroradiometer values for x, y, and fL.

The projector holds the on-screen color and brightness level until the same or another Capture button is selected.

- c) Repeat steps a and b for the remaining drive percentage set points until all x, y, and fL values are entered.

Spectroradiometer measurements can be captured in any order but all three x, y, and fL measurements must be entered before moving onto the next capture. You can recapture a specific measurement at any time during the process by selecting the Capture button. In this case, the measured spectroradiometer and color sensor values are reset.

- d) Once all the color sensor and measured values are entered for all rows, select **Apply and Save**.

7. Verify and complete the calibration.

- a) Select a white point to measure by selecting either the **DCI, D65**, or **Custom** white point buttons.

Once selected, the projector automatically enables LiteLOC™, selects a White test pattern with uncorrected colors at the white point specified, and sets the brightness to 80%.

- b) Using a spectroradiometer, measure screen x and y values at the center of the screen.

To verify the calibration has been successfully applied, the measured white point must be within the expected tolerance.

- c) When complete, select **Finish**.

The projector output is configured according to the currently selected calibration file and you are returned to the Sensor-to-screen Calibration menu.

Editing the existing calibration file parameters

Make corrections to the existing calibration file parameters, when the values from the spectroradiometer were entered in error.

Only applies to: CP44xx-RGB and CP24xx-RGB

1. Select **Menu > Color Settings > Sensor-to-screen Calibration**.
2. Select a user-defined calibration file.
3. Edit any of the x, y, or fL values by selecting the field under Measured Values and using the numeric keypad to enter the updated value.
 - x and y value range: 0.0001 to 0.9999
 - fL value range: 0.01 to 9999.99.
4. To save the updated file to the projector, select **Save**.

Verifying the sensor-to-screen calibration

Check the integrity of the calibration, if required.

Only applies to: CP44xx-RGB and CP24xx-RGB

1. Navigate to **Menu > Color Settings > Sensor-to-screen Calibration.**
2. In the right toolbar, select **Test Patterns.** 

3. Select the **White** test pattern.
4. Close the Test Patterns window.
5. Select **Verify Calibration.**

If the douser is closed and/or the light source is off, a dialog is displayed informing the user that the douser must be open and the light source turned on before verification can occur. Step 3 of the Calibration wizard opens.

6. Verify and complete the calibration.
 - a) Select a white point to measure by selecting either the **DCI, D65,** or **Custom** white point buttons.
Once selected, the projector automatically enables LiteLOC™, selects a White test pattern with uncorrected colors at the white point specified, and sets the brightness to 80%.
 - b) Using a spectroradiometer, measure screen x and y values at the center of the screen.
To verify the calibration has been successfully applied, the measured white point must be within the expected tolerance.
 - c) When complete, select **Finish.**
The projector output is configured according to the currently selected calibration file and you are returned to the Sensor-to-screen Calibration menu.

Adding a calibration file to the Channel Setup

Select any of the available calibration files stored on the projector system by accessing the 2D Sensor-to-Screen Calibration File or 3D Sensor-to-Screen Calibration File list in the Channel Setup menu.

By default, the 2D and 3D sensor-to-screen calibration files are set to the factory or field calibration data identified as Default in the list. The Default selection references the factory calibration data as long as no field calibration data is available. If field calibration data is available, it is selected as the Default. When a 2D and 3D Sensor-to-screen Calibration file is selected in the Channel Setup, the active channel automatically applies the calibration data according to the 2D or 3D operation of the projector.

1. In the left navigation menu, select **Channel Setup.**
2. Select the channel you want to add the calibration file to.
3. From either the **2D Sensor-to-Screen Calibration File** or **3D Sensor-to-Screen Calibration File** list, select the calibration file.
4. Select **Save.**

Managing the lamp

Optimizing lamp performance can make sure you receive the brightest, most uniform image possible for the life of the lamp.

Only applies to: CP2415-Xe, CP2420-Xe, CP4420-Xe

For more information on Christie Xenolite® lamps, refer to <https://www.christiedigital.com/products/cinema/cinema-lamps/>.

Turning on the lamp

Learn how to turn on the lamp.

Do not attempt operation if the AC supply is outside the specified voltage range.

1. Turn on the circuit breaker for the projector.
2. Select and hold **Power** for two seconds.
3. Select and hold **Lamp On** for two seconds.

Turning off the lamp

Learn how to turn off the lamp and projector.

1. Select and hold **Lamp Off** for two seconds.
2. Select and hold **Power Off** for two seconds.
3. Wait for the lamp to cool down and then disconnect the projector from AC power and turn off the circuit breaker for the projector.

Adjusting the lamp power

Learn how to adjust the lamp power.

1. In the left navigation menu, select **Lamp Settings > Lamp Power/LiteLOC Setup**.
2. Increase or decrease the **Power %** value.
3. Select **Set Target**.
4. Select **Enable LiteLOC**.

Changing the lamp power percentage

Learn how to change the lamp power percentage.

Entering a new Lamp Power percentage temporarily disables LiteLOC™ settings.

1. In the left navigation menu, select **Lamp Settings > Lamp Power/LiteLOC Setup**.

2. Increase or decrease the **Power %** value.
3. Save the changes.

Enabling lamp overdrive

Learn how to enable the lamp overdrive feature to accommodate an unusual situation. This feature is not meant for regular use.



Lamp overdrive allows the lamp to be driven up to 10% higher than the maximum power covered by the Champion warranty or up to the maximum output of the power supply. Enabling this feature can void warranty. Check to see if your lamp supports lamp overdrive.

1. Select **Service Setup > Preferences > Light Source**.
2. Select **Enable Lamp Overdrive**.
3. At the confirmation prompt, select **OK**.
4. To disable the lamp overdrive, *perform a factory restore* (on page 104).

Using LampLOC™ to adjust the lamp position

To ensure optimal lamp performance and peak brightness at the screen for the life of the lamp, use LampLOC™ to adjust the lamp position when you install a new lamp in the projector. After making the adjustment, the lamp is well-centered and distanced correctly from the remainder of the illumination system.

Before adjusting LampLOC, make sure the lamp is on and the douser (shutter) is open during the adjustment. Christie recommends a 10 minute warm-up.

1. In the left navigation menu, select **Lamp Settings > LampLOC**.
2. Toggle the **Display White** test pattern button.
This test pattern enables you to view the LampLOC progress on-screen.
3. Select **Align Auto**.

Manually adjusting the lamp position

Manually adjust the lamp position using a light meter.

1. In the right menu, select **Test pattern**.
2. Select **RGB-12bit-Full Screen White**.
3. Mount a light meter on a tripod and center it with the lens.
The distance from the lens does not matter. You may need an attenuator or an internal foil aperture.
4. In the left navigation menu, select **Lamp Settings > Lamp LOC**.
5. Select the directional arrows to adjust the value displayed in the Z field.
The brightness reading in front of the lens should be maximized.
6. Select the directional arrows to adjust the values displayed in the X and Y fields.
The brightness reading in front of the lens should be maximized.
7. Repeat steps 5 to 6 taking your readings at the screen instead of at the lens.

8. If required, run **LampLOC > Auto Align**.

Viewing lamp information

View information on the lamps previously installed in the projector or when a new lamp was added.

In the left navigation menu, select **Lamp Settings > Lamp Manager**.

Setting a lamp warranty date alarm

Set an alarm to indicate when a lamp reaches its warranty date.

1. In the left navigation menu, select **Service Setup > Preferences**.
2. In the **Alarm Triggers** area, select **Lamp Expiry**.

Setting a lamp half-life alarm

Set an alarm to indicate when a lamp has reached its half-life.

1. In the left navigation menu, select **Service Setup > Preferences**.
2. In the **Alarm Triggers** area, select **Lamp Half Life**.

Lamp power ratings and warranty hours

Determine the minimum and maximum lamp power ratings and warranty hours for each lamp.

Find more information about Cinema lamp warranties on the Christie website:

<https://www.christiedigital.com/help-center/warranties/cinema-warranties/>

CP2415-Xe

Lamp model	Champion Warranty hours	Minimum lamp power	Minimum lamp power (%)	Maximum lamp power	Maximum lamp power (%)
CDXL-14M	3,000	1,000	70%	1,430	100%
CDXL-16M	3,000	1,000	63%	1,600	100%
CDXL-18SD	1,750	1,260	70%	1,800	100%
CDXL-20SD	1,000	1,400	70%	2,000	100%
CDXL-23S	700	1,610	70%	2,300	100%
CDXL-23SUP	900	1,610	70%	2,300	100%

CP2420-Xe and CP4420-Xe

Lamp model	Champion Warranty hours	Minimum lamp power	Minimum lamp power (%)	Maximum lamp power	Maximum lamp power (%)
CDXL-20	2,400	1,400	70%	2,000	100%
CDXL-20LB	2,400	1,400	70%	2,000	100%
CDXL-20SP	3,200	1,400	70%	2,000	100%
CDXL-30	1,500	2,100	70%	3,000	100%
CDXL-30SD	1,000	2,100	70%	3,000	100%
CDXL-30SP	1,900	2,100	70%	3,000	100%
CDXL-30SUP	1,500	2,100	70%	3,000	100%

Managing user accounts

Learn how to create new user accounts, modify the properties of those accounts, and remove the accounts. A user account is a set of credentials consisting of both a username and password allowing access to projector settings.

Roles and permissions

The following table outlines the high-level permissions for a given role.

Feature	Operator	Manager	Installer	Service
Scheduler	X	X	X	X
Playlist Editor*		X	X	X
Content Manager*		X	X	X
Laser/lamp settings			X	X
Color settings			X	X
Image Settings			X	X
Channel setup			X	X
Status	X	X	X	X
Diagnostics	X	X	X	X
Automation			X	X
Service setup		X	X	X
About	X	X	X	X

* Available when the IMB-S4 is installed.



- The Manager role has limited access to the Service Setup menu.
- The Operator role has limited access to the Scheduler menu.
- A Marriage role exists for the purpose of marrying a projector and the installed media block. It has similar permissions to the Installer role.

Adding a user account

Adding a user account allows users to access projector menus.

1. In the left navigation menu, select **Service Setup > User Accounts**.
2. Select **+**.
3. Complete the Name, Permissions, Password, and Confirm Password fields.
4. Select **Save**.

Changing user account permissions

Change user account permissions to limit or increase access to projector menus and functionality.

1. In the left navigation menu, select **Service Setup > User Accounts**.
2. In the left pane, select a user account.
3. Select **Edit**.
4. In the Permissions list, select a new permissions setting.
5. Select **Save**.

Changing a user account password

Periodically change a user account password to limit access to projector menus and functionality to authorized users.

1. In the left navigation menu, select **Service Setup > User Accounts**.
2. In the left pane, select a user account.
3. Select **Edit**.
4. Select **Change password**.
5. Complete the New Password and Confirm Password fields.
6. Select **Save**.

Deleting a user account

Delete a user account to prevent access to projector menus and functionality.

1. In the left navigation menu, select **Service Setup > User Accounts**.
2. In the left pane, select a user account.
3. Select **Delete**. 
4. To confirm the deletion, select **Delete**.

Network settings

Learn how to connect the projector to media devices and wired networks.



The system provides the MAC address of the projector automatically.

Connecting the projector to the theater network

Connect the projector to the theater network to control it remotely and allow it to communicate with other network devices.

1. Connect the Ethernet cable from the theater network to the **Management** port on the input panel.
2. In the left navigation menu, select **Service Setup > Network Settings**.
3. Select the **Ethernet Settings** tab.
4. In the Port list, select **Management**.
5. Enter the network settings:
 - To obtain the network settings automatically, select **Automatic**.
 - To enter the settings manually, select **Manual** and complete these fields:

Field	Description
IP Address	IP address of the projector
Subnet Mask	Subnet mask to which the IP address belongs
Gateway	IP address for the network gateway
Primary DNS	IP address of the primary DNS server
Secondary DNS	IP address of the secondary DNS server

6. Select **Save**.

Activating SNMP

Activate the Simple Network Management Protocol (SNMP) to monitor the theater network for conditions that indicate communication or hardware failures.

On CineLife+ projectors, SNMP is enabled by default.

1. In the left navigation menu, select **Service Setup > Network Settings**.
2. Select the **SNMP** tab.
3. Select the **SNMP** slider.
The color of the slider changes to blue to indicate it is active.

4. In the SNMP Settings area, select the SNMP version.
5. Complete the Trap Receiver IP fields.
A trap receiver captures, displays, and logs SNMP traps. Traps are event notices sent immediately to the trap receiver from a network device. The SNMP device does not need to use resources to poll for these event notices.
6. In the Blocked SNMP Traps area, select the SNMP traps you want to block.
7. Select **Save**.

Downloading MIB information

A Management Information Base (MIB) file contains the definitions for the device being managed by the SNMP protocol.

1. In the left navigation menu, select **Service Setup > Network Settings**.
2. Select the **SNMP** tab.
3. Select **Download MIB**.
4. Depending on your browser settings, browse to the location where you want to save the MIB file.
5. In the Name field, enter a name for the MIB file.
6. Select **Accept**.
7. Select **OK**.

Managing content, playlists, and storage

Content, playlists, storage, and audio settings are managed through the Integrated Media Block (IMB). For detailed information on installing and operating the IMB, refer to the documentation provided with your IMB device. Tasks include the following:

- Installing the IMB in the projector
- Connecting portable or enterprise storage
- Managing content, including key delivery message (KDM) and security keys
- Managing and scheduling playback
- Setting up audio
- Setting up playback automation

Customizing 3D mover delay

3D mover delay provides a preset delay to the 3D signal connected to the passive 3D system when transitioning between 3D clips in a playlist.

1. In the left navigation menu, select **Service Setup > Preferences**.
2. Select **Configuration**.
3. Navigate to the 3D Mover Delay section.
4. In the 3D Mover Delay (ms) field, enter a value in milliseconds between 1 and 2000. The default value is 0.

Setting up an integrated media block

Configure the CineLife+ projector to work with an Integrated Media Block (IMB).

Selecting Integrated Media Block (IMB) preferences

Choose from the available options to set the type of Integrated Media Block (IMB).

1. In the left navigation menu, select **Service Setup > Preferences**.
2. Select **IMB**.
3. In the Type list, select the **Christie IMB** for the IMB-S4.
4. For the IMB to power on when the projector is in Standby mode, enable the **IMB Powered in Standby** slider.
Enable the **IMB Powered in Standby** option if content ingest should be done in off hours (when projector is in Standby mode) or disabled when power savings is a higher priority and content ingest is only done when the projector is in Power On mode
5. To determine the homepage content when logging in, select **Upcoming Events** if using the IMB-S4 scheduler or **Status** to see the projector status instead.
6. Enable or disable the **Enable IMB FTP Server Access via Projector Management port** option as required.
When enabled, the projector FTP server is accessible using the TCP port 2121 and the IMB FTP server is accessible using the TCP port 21. Christie recommends not performing an ingest while playback is underway.
7. When the system prompts you to reboot the projector, select **Reboot**.
8. After the projector has restarted, log in with your user account.

Activating marriage

After selecting the Integrated Media Block (IMB) type, you must install the IMB and complete marriage to display secure content and to comply with the Digital Cinema Initiatives (DCI) specification. You cannot complete marriage remotely.

For more information on installing the IMB, see the appropriate IMB installation documentation.

You cannot complete marriage remotely because you must select the **Marriage** button on the input panel during the marriage process.

1. If applicable, verify the device is added on the IMB nad has a network connection.

2. Verify the marriage ring is installed correctly and an anti-tamper alarm does not appear on the touch panel.
3. In the left navigation menu, select **Service Setup** > **Marriage Setup**.
4. Select **Start** and complete the Marriage Setup wizard.
At the Arming stage, enter the Marriage password.
5. Select **Finish**.

Enabling Integrated Media Block (IMB) Powered in Standby mode

Enable the projector to turn on the Integrated Media Block (IMB) to allow ingesting of content to the IMB when the projector is in Standby Mode.

1. To set the type of IMB, select **Service Setup** > **Preferences**.
2. Select **IMB**.
3. Enable the **IMB Powered in Standby** option.

Working with channels

Create channels to store customized projector settings for different inputs.

Adding a channel for HDMI input

Create a channel to store customized projector settings for input devices connected to the HDMI port.

1. In the left navigation menu, select **Channel Setup**.
2. Select **+ Create New Channel**.
3. In the Enter a new file name field, enter the channel name.
4. Select **Create**.
5. Complete these fields:

Field Name	Description
Input Type	Select the input signal sources from one of the following: <ul style="list-style-type: none"> • HDMI Input - 1 • HDMI Input - 2 • HDMI 3D LR
Data Format	Bit-depth, sampling format, and color space of the input signal are automatically determined from the metadata carried in the source. Auto (Default)
Scan Type	Scanning format of the input signal (interlaced or progressive) is automatically determined from the metadata carried in the source or by measuring scanning parameters of the source. Auto (Default)
3D Sync Input Mode	Specifies whether a specific frame of input data has left eye or right eye data. Select one of the following. <ul style="list-style-type: none"> • Auto (Default)—The left-eye/right-eye 3D-sync information is automatically determined from the metadata carried in the source or from the specific input type selection. • 2D mode—Forces the input signal to be interpreted as a 2D signal, overriding any metadata in the input signal.
Color Space	The method of color decoding for the current source. Auto (Default)
ILS File	Intelligent Lens System™ (ILS) file associated with the channel.
2D Light Source File	2D light source file associated with the channel. Any changes made to the file settings are applied to all channels using this file.

Field Name	Description
3D Light Source File	3D light source file associated with the channel. Any changes made to the file settings are applied to all channels using this file.
2D Sensor-to-screen Calibration File	2D sensor-to-screen calibration file associated with the channel.
3D Sensor-to-screen Calibration File	3D sensor-to-screen calibration file associated with the channel.
2D MCGD File	Measured Color Gamut Data file associated with the 2D image.
3D MCGD File	Measured Color Gamut Data file associated with the 3D image.
TCGD File	Target Color Gamut Data file associated with the channel.
Screen File	Screen type, masking, cropping, and lens settings for the channel.
Gamma File	Gamma correction required for the proper tonal range of the source material.
3D File	3D settings files associated with the channel.
Source File	Resolution and aspect ratio for the channel.
HDMI EDID File	EDID associated with the channel.
Christie Pureformity Color™ Correction Files	Color correction file associated with the channel. Bypass (Default)
Warp File	Warp file associated with the channel. Bypass (Default)

6. Select **Save**.

Adding a channel for SDI input

Create a channel to store customized projector settings for input devices connected to the SDI port.

1. In the left navigation menu, select **Channel Setup**.
2. Select **+ Create New Channel**.
3. In the Enter a new file name field, enter the channel name.
4. Select **Create**.
5. Complete these fields:

Field Name	Description
Input Type	Select the input signal sources from one of the following: <ul style="list-style-type: none"> • SDI - 1 • SDI - 2 • SDI - 3 • SDI - 4 • SDI - Dual-Link (1,2) • SDI - Dual-Link (3,4)

Field Name	Description
	<ul style="list-style-type: none"> • SDI - Quad-Link (2SI) • SDI - Quad-Link (SQ Div) • SDI 3D LR (1,2) • SDI 3D LR (3,4) • SDI - Dual-Link 3D LR (1,2)(3,4)
Data Format	<p>Bit-depth, sampling format, and color space of the input signal are automatically determined from the metadata carried in the source.</p> <p>Auto (Default)</p>
Scan Type	<p>Determines the input scanning format. Select one of the following:</p> <ul style="list-style-type: none"> • Auto (Default)—The scanning format of the input signal (interlaced or progressive) is automatically determined from the metadata carried in the source or by measuring scanning parameters of the source. • Progressive—Forces the input signal scanning format to progressive, overriding any metadata in the input signal.
3D Sync Input Mode	<p>Specifies whether a specific frame of input data has left-eye or right-eye data. Select one of the following:</p> <ul style="list-style-type: none"> • Auto (Default)—The left-eye/right-eye 3D-sync information is automatically determined from the metadata carried in the source or from the specific input type selection. • 2D mode—Forces the input signal to be interpreted as a 2D signal, overriding any metadata in the input signal.
Color Space	Method of color decoding for the current source.
ILS File	Intelligent Lens System™ (ILS) file associated with the channel.
2D Light Source File	2D light source file associated with the channel. Any changes made to the settings are applied to all channels using this file.
3D Light Source File	3D light source file associated with the channel. Any changes made to the settings are applied to all channels using this file.
2D Sensor-to-screen Calibration File	2D sensor-to-screen calibration file associated with the channel.
3D Sensor-to-screen Calibration File	3D sensor-to-screen calibration file associated with the channel.
2D MCGD File	Measured Color Gamut Data file associated with the 2D image.
3D MCGD File	Measured Color Gamut Data file associated with the 3D image.
TCGD File	Target Color Gamut Data file associated with the channel.
Screen File	Screen type, masking, cropping, and lens settings for the channel.
Gamma File	Gamma correction required for the proper tonal range of the source material.
3D File	3D settings files associated with the channel.
Source File	Resolution and aspect ratio for the channel.

Field Name	Description
Christie Pureformity Color™ Correction Files	Color correction file associated with the channel. Bypass (Default)
Warp File	Warp file associated with the channel. Bypass (Default)

6. Select **Save**.

Adding a channel for DisplayPort input

Create a channel to store customized projector settings for input devices connected to the HDMI port.

1. In the left navigation menu, select **Channel Setup**.
2. Select **+ Create New Channel**.
3. In the Enter a new file name field, enter the channel name.
4. Select **Create**.
5. Complete these fields:

Field Name	Description
Input Type	Select the input signal sources from one of the following: <ul style="list-style-type: none"> • DisplayPort Input - 1 • DisplayPort Input - 2 • DisplayPort Input 3D LR
Data Format	Bit-depth, sampling format, and color space of the input signal are automatically determined from the metadata carried in the source. Auto (Default)
Scan Type	Scanning format of the input signal (interlaced or progressive) is automatically determined from the metadata carried in the source or by measuring scanning parameters of the source. Auto (Default)
3D Sync Input Mode	Specifies whether a specific frame of input data has left-eye or right-eye data. Select one of the following: <ul style="list-style-type: none"> • Auto (Default)—The left-eye/right-eye 3D-sync information is automatically determined from the metadata carried in the source or from the specific input type selection.
Color Space	Method of color decoding for the current source. Auto (Default)
ILS File	Intelligent Lens System™ (ILS) file associated with the channel.
2D Light Source File	2D light source file associated with the channel. Any changes made to the file settings are applied to all channels using this file.
3D Light Source File	3D light source file associated with the channel. Any changes made to the file settings are applied to all channels using this file.

Field Name	Description
2D Sensor-to-screen Calibration File	2D sensor-to-screen calibration file associated with the channel.
3D Sensor-to-screen Calibration File	3D sensor-to-screen calibration file associated with the channel.
2D MCGD File	Measured Color Gamut Data file associated with the 2D image.
3D MCGD File	Measured Color Gamut Data file associated with the 3D image.
TCGD File	Target Color Gamut Data file associated with the channel.
Screen File	Screen type, masking, cropping, and lens settings for the channel.
Gamma File	Gamma correction required for the proper tonal range of the source material.
3D File	3D settings files associated with the channel.
Source File	Resolution and aspect ratio for the channel.
DisplayPort EDID File	EDID associated with the channel.
Christie Pureformity Color™ Correction Files	Color correction file associated with the channel. Bypass (Default)
Warp File	Warp file associated with the channel. Bypass (Default)

6. Select **Save**.

Adding a channel for Integrated Media Block (IMB) input

Create a channel to store customized projector settings for input devices connected to the Integrated Media Block (IMB).

1. In the left navigation menu, select **Channel Setup**.
2. Select **+ Create New Channel**.
3. In the Enter a new file name field, enter the channel name.
4. Select **Create**.
5. Complete these fields:

Field Name	Description
Input Type	Select IMB.
3D Sync Input Mode	For Christie IMB, specifies how 3D input data is encoded. <ul style="list-style-type: none"> • Auto (Default)—Automatically encodes 3D input data. • 2D Mode—No 3D synchronization is applied. 3D Sync Input Mode is not required when using the Christie IMB.
ILS File	Intelligent Lens System™ (ILS) file associated with the channel.

Field Name	Description
2D Light Source File	2D light source file associated with the channel. Any changes made to the file settings are applied to all channels using this file.
3D Light Source File	3D light source file associated with the channel. Any changes made to the file settings are applied to all channels using this file.
2D Sensor-to-screen Calibration File	2D sensor-to-screen calibration file associated with the channel.
3D Sensor-to-screen Calibration File	3D sensor-to-screen calibration file associated with the channel.
2D MCGD File	Measured Color Gamut Data file associated with the 2D image.
3D MCGD File	Measured Color Gamut Data file associated with the 3D image.
TCGD File	Target Color Gamut Data file associated with the channel.
Screen File	Screen type, masking, cropping, and lens settings for the channel.
Gamma File	The gamma correction required for the proper tonal range of the source material.
3D File	3D settings file associated with the channel.
Source File	The resolution and aspect ratio for the channel.
Christie Pureformity Color™ Correction Files	The color correction file associated with the channel. Bypass (Default)
Warp File	Warp file associated with the channel. Bypass (Default)

6. Select **Save**.

Selecting the active channel

Select a channel to use customized projector settings for different inputs.

1. In the right toolbar, select **All Channels**.
The All Channels window displays the available channels and the active channel is highlighted.
2. Select a channel.
In the Channel Setup panel, a green checkmark  indicates the active channel.
3. Select **Close**.

Editing an existing channel

Edit an existing channel when the parameters of the input device change.

1. In the left navigation menu, select **Channel Setup**.
2. In the left pane, select a channel.
3. Edit the channel settings.
4. Select **Save**.

Renaming a channel

Rename an existing channel.

1. In the left navigation menu, select **Channel Setup**.
2. In the left pane, select a channel.
3. Select **Rename Channel**.
4. Enter a new name.
5. Select **Rename**.

Copying existing channel settings to a new channel

Copy a channel to create a new channel with similar settings.

1. In the left navigation menu, select **Channel Setup**.
2. In the left pane, select a channel.
3. Select **Save As**.
4. Enter a name for the new channel and select **Save**.
5. If input type changes, check all settings.



Viewing the channel list

The channel list displays all of the available channels.

- In the left navigation menu, select **Channel Setup**.
Under Channel Setup, the available channels are displayed in the left pane. A green checkmark  indicates the active channel.
Alternatively in the right toolbar, select **All Channels**.
The Channels window displays the available channels and the active channel is highlighted.

Moving a channel up or down the channel list

If a channel is selected frequently, move it to the top of channel list for convenient access. If not selected frequently, move it to the bottom of the channel list.

1. In the left navigation menu, select **Channel Setup**.
2. In the left pane, select a channel.
3. To move the channel up or down the list, select  or .

Deleting a channel

Delete a channel when the settings for the input device are no longer required.

1. In the left navigation menu, select **Channel Setup**.
2. In the left pane, select a channel.
3. Select **Delete**. 
4. To confirm the deletion, select **Delete**.

Managing color setting files

Use the procedures in this section to manage color setting files. When associated with a channel, a color setting file defines the color output for the content.

Custom color space conversion files

Creating a custom color space file requires a specific process and format.

This information provided in this section are for reference purposes only.

The Color Space Conversion (CSC) core in CineLife+™ converts from an arbitrary input color space to an RGB output color space. Both the input and output spaces are assumed to be non-linear (gamma, log, or other). This operation is calculated using three 3x1 matrix multipliers (triple dot product).

A second function of this component is to adjust the offset of the pixel data both before and after color space conversion.

$$\begin{bmatrix} R_{preotf} \\ G_{preotf} \\ B_{preotf} \end{bmatrix} = \begin{bmatrix} C_{preotf1} & C_{preotf2} & C_{preotf3} \\ C_{preotf4} & C_{preotf5} & C_{preotf6} \\ C_{preotf7} & C_{preotf8} & C_{preotf9} \end{bmatrix} * \begin{bmatrix} R_{in} \\ G_{in} \\ B_{in} \end{bmatrix} + \begin{bmatrix} InputOffset1 \\ InputOffset2 \\ InputOffset3 \end{bmatrix}$$

$$\begin{bmatrix} R_{out} \\ G_{out} \\ B_{out} \end{bmatrix} = \begin{bmatrix} C_{postotf1} & C_{postotf2} & C_{postotf3} \\ C_{postotf4} & C_{postotf5} & C_{postotf6} \\ C_{postotf7} & C_{postotf8} & C_{postotf9} \end{bmatrix} * \begin{bmatrix} R_{postotf} \\ G_{postotf} \\ B_{postotf} \end{bmatrix} + \begin{bmatrix} OutputOffset \\ OutputOffset \\ OutputOffset \end{bmatrix}$$

The following table provides the CSC transfer function descriptions.

Parameter	Description
R _{in}	The Red or C _r input pixel data channel received from the input video source
G _{in}	The Green or Y input pixel data channel received from the input video source
B _{in}	The Blue or C _b input pixel data channel received from the input video source
R _{preotf}	The Red pixel data passed into the degamma module
G _{preotf}	The Green pixel data passed into the degamma module
B _{preotf}	The Blue pixel data passed into the degamma module
R _{postotf}	The Red pixel data received from the degamma module
G _{postotf}	The Green pixel data received from the degamma module
B _{postotf}	The Blue pixel data received from the degamma module

Parameter	Description
Cpreotf	Matrix multiplier coefficients with a value from -4 to +4 applied to the input values
Cpostotf	Matrix multiplier coefficients with a value from a -4 to +4 applied to the post degamma values
Input Offset	Values range from -4095 to +4095 and are added to the input pixel data channels
Output Offset	A value from 0 to +1, the values are added to the output pixel data channels
Rout	The Red output pixel value in RGB output color space
Gout	The Green output pixel value in RGB output color space
Bout	The Blue output pixel value in RGB output color space

Example Rec 709 to RGB

Rec 709 specifies how to convert RGB to digital Y'C_BC_R. The reverse process is not specified but is implied in the calculations (from ITU-R REC BT.709).

```
R, G, B gamma encoded video in the range 0 to 1
n = bit depth (8,10,or 12)
Y = 0.2126*R + 0.7152*G + 0.0722*B
Cb = (B-Y) / 1.8556
Cr = (R-Y) / 1.5748
DY = int[(219 * Y + 16) * 2^(n-8)]
DCb = int[(224 * Cb + 128) * 2^(n-8)]
DCr = int[(224 * Cr + 128) * 2^(n-8)]
```

Reversing the steps and scaling so that R, G, B are in range 0 to 4095

```
scaleY = (2^n-1) / (219 * 2^(n-8))
scaleC = (2^n-1) / (224 * 2^(n-8))
Y = scaleY * DY
Cb = scaleC * DCb
Cr = scaleC * DCr
```

Solving for RGB

$$\begin{bmatrix} R \\ G \\ B \end{bmatrix} = \begin{bmatrix} 1.5748 & 1.0000 & 0 \\ -0.4681 & 1.0000 & -0.1873 \\ 0.0000 & 1.0000 & 1.8556 \end{bmatrix} * \begin{bmatrix} C_r \\ Y \\ C_b \end{bmatrix}$$

Combining the scaling operation

$$\begin{bmatrix} R \\ G \\ B \end{bmatrix} = \begin{bmatrix} 1.5748 & 1.0000 & 0 \\ -0.4681 & 1.0000 & -0.1873 \\ 0.0000 & 1.0000 & 1.8556 \end{bmatrix} * \begin{bmatrix} scaleC & 0 & 0 \\ 0 & scaleY & 0 \\ 0 & 0 & scaleC \end{bmatrix} * \begin{bmatrix} C_r \\ Y \\ C_b \end{bmatrix}$$

Resultant Coefficients at 12 bits

$$\begin{bmatrix} R \\ G \\ B \end{bmatrix} = \begin{bmatrix} 1.7994 & 1.1687 & 0.0000 \\ -0.5349 & 1.1687 & -0.2140 \\ 0.0000 & 1.1687 & 2.1202 \end{bmatrix} * \begin{bmatrix} C_r \\ Y \\ C_b \end{bmatrix}$$

Input Offset

This is a signed 16 bit integer value in hex. Examples:

```
0       : 0x0000
256    : 0x0100
2048   : 0x0800
-256   : 0xFF00
-2048  : 0xF800
```

Y'C_BC_R is 8 or 10 bits with the minimum Y value of 16 or 64 respectively. The input is placed at the top of the 12 bit integer, which will make the minimum Y value 256 for both cases. Input offset will be -256, the value is stored in hex, becomes 0xFF00 and is stored in InputOffset2.

For the C_BC_R portion, the nominal value is 128 for 8 bit, or 512 for 10 bits. When this value is stored at the top of a 12 bit integer for both cases the nominal offset is 2048 or half way through 4096. Therefore, the InputOffset1 and InputOffset3 will be -2048, the value is stored in hex and becomes 0xF800.

Output Offset

This is a floating point value from -1.0 to 1.0.

For Y'C_BC_R 709, there is no need for an output offset. Therefore, the value is set to 0.

Final Rec 709 core CSC file

The following example displays the format of the CSC xml file.

```
1  <?xml version="1.0"?>
2  <CoreCSCFile>
3    <PreEotf>
4      <Coefficient1>1.7994</Coefficient1>
5      <Coefficient2>1.1687</Coefficient2>
6      <Coefficient3>0</Coefficient3>
7      <Coefficient4>-0.5349</Coefficient4>
8      <Coefficient5>1.1687</Coefficient5>
9      <Coefficient6>-0.2140</Coefficient6>
10     <Coefficient7>0</Coefficient7>
11     <Coefficient8>1.1687</Coefficient8>
12     <Coefficient9>2.1202</Coefficient9>
13   </PreEotf>
14   <PostEotf>
15     <Coefficient1>1.0</Coefficient1>
16     <Coefficient2>0</Coefficient2>
17     <Coefficient3>0</Coefficient3>
18     <Coefficient4>0</Coefficient4>
19     <Coefficient5>1.0</Coefficient5>
20     <Coefficient6>0</Coefficient6>
21     <Coefficient7>0</Coefficient7>
22     <Coefficient8>0</Coefficient8>
23     <Coefficient9>1.0</Coefficient9>
24   </PostEotf>
25   <InputOffset1>0xF800</InputOffset1>
26   <InputOffset2>0xFF00</InputOffset2>
27   <InputOffset3>0xF800</InputOffset3>
28   <OutputOffset>0</OutputOffset>
29 </CoreCSCFile>
```

Importing a custom color space file

Learn how to import a custom color space file.

1. In the left navigation menu, select **Color Settings > Color Space File Setup**.
2. Select **Import Color Space File**.
3. Browse to the .xml file in one of the following ways.
 - Using the touch panel control—Browse for the file on the USB flash drive.
 - Using the web user interface—Browse for the file on your computer.
4. Open the file in one of the following ways.
 - Using the touch panel control—Select **Accept**.
 - Using the web user interface—Select **Open**.

Creating an MCGD file

Create Measured Color Gamut Data (MCGD) files to correct on-screen colors. A colorimeter is required to complete this procedure.

1. Activate the channel using the light source file the MCGD file is being created for.
2. Turn on the light source and allow it to operate for 20 minutes.
3. In the left navigation menu, select **Color Settings > MCGD File Setup**.
4. Select **Create**.
5. Enter a name for the MCGD file and select **Create**.
6. If the MCGD file will be associated with a 3D channel, select the **3D Sync** slider.
7. In the red area of the chromaticity image, select the empty circle.
The test pattern is automatically displayed.
8. Measure the red chromaticity with the colorimeter.
9. Enter the red chromaticity value in the **x** field.
10. Select **Next** and enter the red chromaticity value in the **y** field.
11. For the green, blue, white (center circle), and black chromaticity measurements, repeat steps 7 to 10.
12. Select **Save**. 

Editing an existing MCGD file

Edit an existing Measured Color Gamut Data (MCGD) file when on-screen color readings change.

1. In the left navigation menu, select **Color Settings > MCGD File Setup**.
2. In the MCGD File list, select a MCGD file.
3. Edit the measured color values.
4. Select **Save**. 

Copying existing MCGD file settings to a new file

Copy an existing Measured Color Gamut Data (MCGD) file when you want to create a new MCGD file with similar settings.

1. In the left navigation menu, select **Color Settings > MCGD File Setup**.
2. In the MCGD File list, select a MCGD file.
3. Select **Save As.** 
4. Enter a name for the MCGD file and select **Save**.

Deleting an MCGD file

Delete a Measured Color Gamut Data (MCGD) file when it is no longer required.

1. In the left navigation menu, select **Color Settings > MCGD File Setup**.
2. In the **MCGD File** list, select a MCGD file.
3. Select **Delete.** 
4. To confirm the deletion, select **Delete**.

Creating a TCGD file

Typically, Target Color Gamut Data (TCGD) file settings are defined by the content provider and are not modified. A colorimeter is required to complete this procedure.

1. Turn on the light source and allow it to operate for 20 minutes.
2. In the left navigation menu, select **Color Settings > TCGD File Setup**.
3. Select **Create**.
4. Enter a name for the TCGD file and select **Create**.
5. To display test clips automatically when selecting a color in the chromaticity image, select **Automatically Display Test Clip**.
6. To modify the white clipping values and improve image detail in bright areas of the image, select **Use White Clip**.
7. Select the option button in the red area of the chromaticity image to display the red test pattern.
8. Measure the red chromaticity with the colorimeter.
9. Enter the red chromaticity values in the **Red x** and **Red y** fields.
10. Adjust the **Gain** value to modify the color brightness.
11. For the magenta, blue, cyan, white, yellow, and green chromaticity measurements, repeat steps 7 to 10.
12. To adjust the color of the white light in a specific area of the screen, select **White Tolerance** and a screen area.
13. Select **Save.** 

Editing an existing TCGD file

Edit an existing Target Color Gamut Data (TCGD) file when color readings change.

1. In the left navigation menu, select **Color Settings > TCGD File Setup**.
2. In the **TCGD File** list, select a TCGD file.
3. Edit the TCGD file settings.
4. Select **Save**. 

Copying existing TCGD file settings to a new file

Copy an existing Target Color Gamut Data (TCGD) file when you want to create a new TCGD file with similar settings.

1. In the left navigation menu, select **Color Settings > TCGD File Setup**.
2. In the TCGD File list, select a TCGD file.
3. Select **Save As**. 
4. Enter a name for the TCGD file and select **Save**.

Deleting a TCGD file

Delete a Target Color Gamut Data (TCGD) file when it is no longer required.

1. In the left navigation menu, select **Color Settings > TCGD File Setup**.
2. In the TCGD File list, select a TCGD file.
3. Select **Delete**. 
4. To confirm the deletion, select **Delete**.

Managing EDID files

Use the procedures in this section to manage EDID files.

Importing an EDID file

Learn how to import an EDID file.

1. In the left navigation menu, select **Service Setup > Preferences**.
2. Select **EDID File Import**.
3. Select **Import EDID**.
4. Browse to the location of the EDID file.
5. Select the EDID file.
6. Select **Open**.

Deleting an EDID file

Delete an EDID file when it is no longer required.

1. In the left navigation menu, select **Service Setup > Preferences**.
2. Select **EDID File Import**.
3. Navigate to the EDID file.
4. Select **Delete**.

Adjusting the image size and position

Learn how to enable and modify projector image settings.

Intelligent Lens System (ILS)

The Intelligent Lens System™ (ILS) automatically recognizes and calibrates a lens.



Warping is disabled when entering the ILS Setup page.

Activating the Intelligent Lens System



Activate the Intelligent Lens System™ (ILS) to automatically adjust the position of the lens.

On CineLife+ projectors, the ILS is enabled by default.

1. In the left navigation menu, select **Service Setup** > **Preferences**.
2. Select **Lens/ILS**.
3. In the right pane, select the **ILS Installed** slider.
The color of the slider changes to blue to indicate the ILS is active.

Creating a new ILS file

Create an Intelligent Lens System™ (ILS) file to set the X, Y, zoom, and focus positions of the lens.

1. In the left navigation menu, select **Image Settings** > **ILS File Setup**.
2. Select **Create**. 
3. Enter a name for the ILS file and select **Create**.
4. In the Lens position area, select the forward, backward, left, or right arrow icons to move the position of the image on the screen.
5. In the **Focus** area, select **Up** (^) or **Down** (v) to increase or decrease image focus.
6. In the **Zoom** area, select **Up** (^) or **Down** (v) to increase or decrease image zoom.
7. Select **Save**. 

Automatically calibrating the ILS

Use the Auto Calibrate feature of the Intelligent Lens System™ (ILS) to find and compensate for motor backlash, and to determine the movement range for the currently installed lens.

1. In the left navigation menu, select **Image Settings > ILS File Setup**.
2. Select **Auto Calibrate**.
3. In the confirmation dialog, select **Continue**.

Editing ILS file settings

Edit Intelligent Lens System™ (ILS) file settings when content requirements change.

1. In the left navigation menu, select **Image Settings > ILS File Setup**.
2. On the right side, in the ILS File list, select an ILS file.
3. Modify the ILS file settings.
4. Select **Save**. 

Copying existing ILS file settings

To duplicate Intelligent Lens System™ (ILS) file settings quickly, copy the settings of an existing file to a new ILS file.

1. In the left navigation menu, select **Image Settings > ILS File Setup**.
2. In the ILS File list, select the ILS file you want to copy.
3. Select **Save As**. 
4. Enter a name for the ILS file and select **Save**.

Deleting an ILS file

Delete an Intelligent Lens System™ (ILS) file when it is no longer required.

1. In the left navigation menu, select **Image Settings > ILS File Setup**.
2. In the ILS File list, select the ILS file you want to delete.
3. Select **Delete**. 
4. To confirm the deletion, select **Delete**.

Resetting the lens

Use the Reset Lens feature to have the Intelligent Lens System™ (ILS) find the home position flags that allow the ILS to compensate for drift over time, or move to its proper position after it has been manually adjusted.

1. In the left navigation menu, select **Image Settings > ILS File Setup**.
2. Select **Reset Lens**.
3. In the confirmation dialog, select **Continue**.

Electronic Color Convergence (ECC)

A lateral convergence error occurs when the red, green, and blue (RGB) primary colors are not converged through projected lenses and is most noticeable at the edges of the screen. To address this, use ECC.

Electronic Color Convergence (ECC) is accomplished by aligning a red, green, and blue sprite, which is displayed at the four corners of the displayed image. For electronic convergence all three colors can be adjusted.

Always align the color components of the sprite to the inner most line color (for each axis). When converged, the three colors should overlap to form white lines. Applying the sprite alignment settings to the screen results in the three colors overlapping to form white lines throughout the image.

One or more poorly converged individual colors may appear adjacent to some or all of the lines.

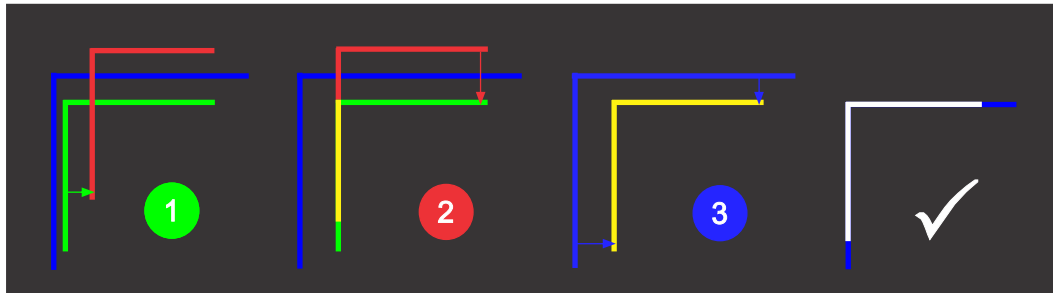

If you wear glasses with corrective lenses when performing this adjustment, make sure you are viewing the test pattern on a straight angle through the optical axis of your glasses and not from a tilted or angled perspective. This avoids a prismatic effect that can appear to shift convergence when viewing at an angle.

Electronically adjusting convergence

Use the electronic color convergence (ECC) feature in the menu to adjust convergence. Only perform electronic convergence when satisfied with the position of the image on the screen.

1. In the left navigation menu, select **Image Settings > ILS File Setup**.
2. Use the arrow to select an ILS file to store the ECC settings.
3. On the ILS File Setup page, select **ECC**.
Each corner of the screen displays three separate sprites, one for each primary color. The user interface displays the Test Pattern controls.
4. Set the Screen Type to **Flat** or **Scope**.
This sets the test pattern and the location of the sprites on the screen. Each sprite appears as the letter L.
5. Set the Sprite Color to **Move** and **Show**.
When first opening the ECC, all Show and all Move colors are selected, so all three sprites are displayed and all three sprites are moved by the directional pad.
6. Select a **Step Size** to control the granularity of the steps from coarse (1/8 pixel per step) to fine (1/64 pixel per step) when using the directional pad.
Sprites can be moved a maximum of 20 pixels.
7. Choose a corner by selecting the circle at a corner of the dashed rectangle.
The selected corner is indicated by a green circle. The X/Y pixel offset (from no correction) displays in red, green, and blue text corresponding to each sprite.

8. Use the directional pad to move the sprites towards the center of the screen.
9. Adjust each sprite so they overlap to create a single white sprite.
 In the example below, the red sprite (in image 1 below) was moved down and the blue sprite (in image 1 below) was moved to the right so they overlap to create the single white sprite (image 2 below).

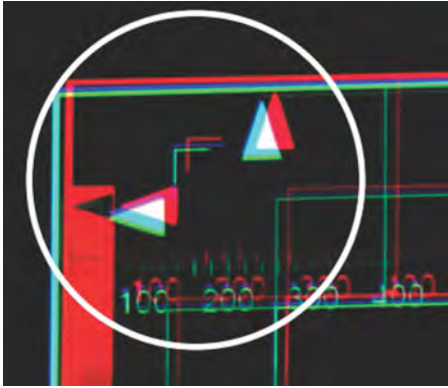

1

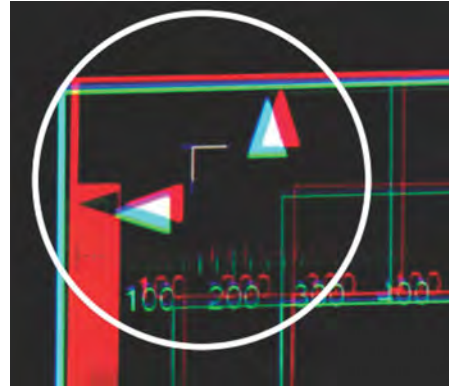

2

10. To set the convergence for that corner of the screen, select **Apply**.

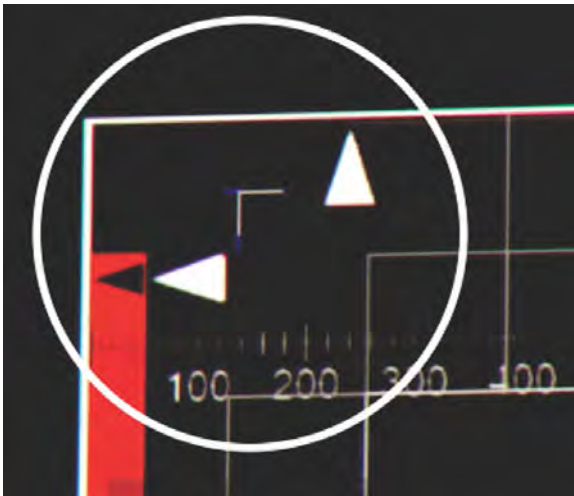

11. Repeat steps 7 to 10 for the remaining corners.
12. If necessary, reset the correction back to zero (no correction) or the previously saved correction by selecting **Reset**.
 In the Reset dialog, reset the current corner or all four corners. When the locations and value are set, select **Reset**.
13. To save the current ECC settings, when the convergence is complete, select **Save** beside the ILS file named at the top of the panel.

Disabling geometry correction



Disable geometry correction when doing convergence.

1. In the left navigation menu, select **Service Setup > Preferences**.

2. Select **Test Patterns**.
3. Select **Uncorrected Geometry**.
Cropping, keystone, warp, and ECC correction are disabled.

Creating a source file

Create source files to store resolution, offset, and aspect ratio settings for input devices. When the Auto Square Pixels file is selected, the incoming video format is automatically detected.

1. In the left navigation menu, select **Image Settings > Source File Setup**.
2. Select **Create**. 
3. Enter a name for the source file and select **Create**.
4. In the Source Media Resolution area, adjust the width and height of the source media.
5. Select an aspect ratio or enter a custom aspect ratio for the source media.
6. In the Position area, adjust the horizontal and vertical position of the source media.
7. Select **Save** .

Editing source file settings

Edit source file settings when the settings of the input device change.

1. In the left navigation menu, select **Image Settings > Source File Setup**.
2. In the Source File list, select a source file.
3. Modify the source file settings.
4. Select **Save**. 

Copying existing source file settings to a new source file

To duplicate existing source file settings quickly, copy the settings of an existing file to a new source file.

1. In the left navigation menu, select **Image Settings > Source File Setup**.
2. In the Source File list, select the source file you want to copy.
3. Select **Save As**. 
4. Enter a name for the source file and select **Save**.



Deleting a source file

Delete a source file when it is no longer required.

1. In the left navigation menu, select **Image Settings > Source File Setup**.
2. In the Source File list, select the source file you want to delete.
3. Select **Delete**. 
4. To confirm the deletion, select **Delete**.

Creating a screen file

Use screen files to define the size of the display panel and image cropping. You can assign the same screen file to multiple input devices.

1. In the left navigation menu, select **Image Settings > Screen File Setup**.
2. Select **Create**. 
3. Enter a name for the screen file and select **Create**.
4. To crop the image in a specific location, select one of the screen icons.
To learn about enabling keystone, see *Using 2D keystone correction* (on page 85).
5. To adjust the amount of cropping on the X or Y axis, move the slider up or down.
6. Select **Save**. 

Editing screen file settings

Edit screen file settings when the image parameters change.

1. In the left navigation menu, select **Image Settings > Screen File Setup**.
2. In the Screen File list, select a screen file.
3. Modify the screen file settings.
To learn about enabling keystone, see *Using 2D keystone correction* (on page 85).
4. Select **Save** 

Copying existing screen file settings to a new screen file

To duplicate screen file settings quickly, copy the settings of an existing file to a new screen file.

Mask and keystone settings are also copied.

1. Select **Image Settings > Screen File Setup**.
2. In the Screen File list, select the screen file you want to copy.
3. Select **Save As** 
4. Enter a name for the source file and select **Save**.

Deleting a screen file

Delete a screen file when it is no longer required.

1. In the left navigation menu, select **Image Settings > Screen File Setup**.
2. In the Screen File list, select the screen file you want to delete.
3. Select **Delete**. 
4. To confirm the deletion, select **Delete**.

Activating a warp file

Activate a warp file to use with a selected channel.

Warp files provide image configuration information to support projection in environments with multiple projectors and complex screen shapes. Warp files are created using an automated process through Christie Mystique™.

For more information on using Christie Mystique in a cinema environment, see the *Mystique User Guide—Cinema Edition (P/N: 020-001240-XX)*.

1. Using Christie Mystique, create the required warp file.
2. Using Mystique, upload the warp file to the projector.
3. On the projector touch panel, navigate to **Image Settings > Warp File Setup**.
4. To activate the warp file, find the file name in the Warp File list and select **Activate**.



If you no longer require a warp file, remove it by selecting **Image Settings > Warp File Setup**. Find the warp file in the list and select **Delete**. 

Adjusting the image

Adjust the projector image. Christie recommends warming the lens before completing these procedures as focus may change as the lens warms.

Correcting vignetting

An image that is brighter at the center than it is at the sides needs vignetting correction.

If your image suffers from vignetting, the lens has reached the end of its offset travel range.

If your installation does not allow the image to be centered with the center of the screen, move the entire projector in the direction of lens travel.

Correcting keystone effect

Keystone effect occurs when you project an image onto the screen at an angle. As a result, the image appears distorted and resembles a trapezoid.



When making the adjustments, set the light source to minimum power.

Horizontal keystone	Vertical keystone
Projector skewed horizontally to the screen	Projector tilted vertically to the screen

1. If the image suffers from slight keystone effect, it can be corrected with electronic cropping.
2. If the keystone effect is severe, unevenly adjust the feet to compensate for projector tilt.
Christie recommends using the lens offset to align the center of the image to the center of the screen before correcting the keystone effect.

3. If one side of the image is longer than another, adjust the tilt and level of the projector.

Using 2D keystone correction

2D keystone correction allows for basic geometry correction.

When Keystone is enabled, features such as masking, electronic color convergence (ECC), and other warping operations defined in the active channel are disabled.

1. In the left navigation menu, select **Image Settings > Screen File Setup**.
2. Toggle on **Keystone**.
3. Select a corner correction point to adjust.
4. Select **Save**.

Masking the screen edges

Conceal the unused edges of a screen with top or side masking.

Typically, you install top and side masking to allow a greater range of adjustment.

1. To create top masking:
 - a) Install movable flat black panels or curtains along the top edge of the screen.
 - b) Raise the curtain for flat images or lower the curtain for scope images.

Top masking theater (1.85 screens)

A	1.85:1 image (flat)
B	2.39:1 image (scope)
C	Masking moved up
D	Top masking to hide screen top

2. To create side masking:
 - a) Install movable flat black panels or curtains along each side of the screen.
 - b) Close the curtain for flat images or open the curtain and zoom for scope images.

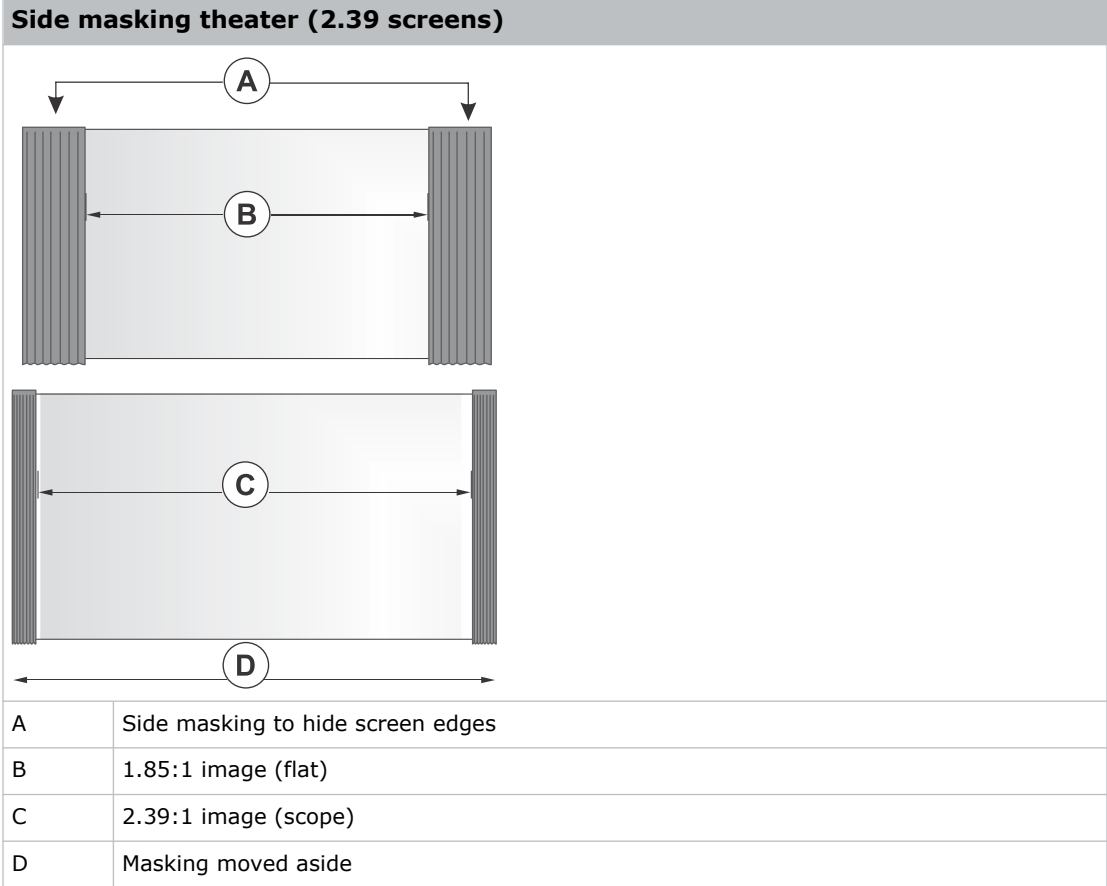

Test patterns

Use the available test patterns to assist with configuration of the projector and to diagnose any issues that may occur.

Displaying a test pattern

Display a test pattern to refine and adjust the projected image or to diagnose and correct image issues.

1. In the right toolbar, select **Test Patterns**. 
2. Select **Full Screen** or **Uncorrected Colors**.
3. Select a test pattern.
When a test pattern is active, a blue bar appears below the test pattern icon in the right pane.
4. To display a 2D test pattern in 3D mode, select the **3D Sync** option.
The **3D Sync** option is selected automatically for 3D test patterns. 3D test patterns cannot be displayed in 2D mode.
5. To change the frame rate of the test pattern display, select from the available Frame Rate options:
 - For 2D test patterns, the available frame rates are 24, 30, 48, and 60 Frames Per Second (FPS). The default value is 24 FPS.
 - For 3D test patterns, the available frame rates are 24 FPS (per eye) and 30 FPS (per eye). The default value is 24 FPS (per eye).

Changing the frame rate of the display can assist with color measurement when working with corrected colors.

When changing the frame rate option, the option is applied to the next test pattern you select unless it is not available for that pattern. If a selected frame rate is not available, the default frame rate is applied for the test pattern display.

Turning off a test pattern

Turn off a test pattern when adjustment of the projected image is complete.

1. In the right toolbar, select **Test Patterns**. 
2. Select **Test Pattern Off**.

Importing a test pattern

Import custom test patterns to meet the specific requirements of your viewing environment.

1. In the right toolbar, select **Test Patterns**. 
2. In the upper right corner, select **Edit**.
3. Select **Import**.
4. Browse to the location of the test pattern file.
5. Select the test pattern file.
6. Select **Open**.
7. In the upper right corner, select **Done**.

Deleting a test pattern

Delete a test pattern no longer required. A test pattern with a lock icon cannot be deleted.

1. In the right toolbar, select **Test Patterns**. 
2. In the upper right corner, select **Edit**.
3. Select a test pattern.
4. Select **Delete**.
5. To confirm the deletion, select **Delete**.
6. In the upper right corner, select **Done**.

Keeping on the test pattern

Learn how to keep on the test pattern when changing channels.

By default, the test pattern turns off when changing channels.

1. In the left navigation menu, select **Service Setup > Preferences**.
2. Select **Test Patterns**.
3. Toggle on **Keep Test Pattern On After Channel Change**.



Working with the scheduler

Use the scheduler to schedule automated events that play automatically on a specific date at a specific time.

Scheduling automation

Schedule automation to run automatically on a specific date and time.

On CineLife+ projectors, the scheduler is enabled by default.

1. In the left navigation menu, select **Scheduler**.
2. To enable scheduled events, move the **Scheduler is off** slider to the right. The color of the slider changes to blue to indicate it is active.
3. To select a date for the scheduled event, select **Calendar**. 
4. Select the week.
5. Select a square below the date and next to the time you want the event to run.
6. Select **+ New Event**.
7. In the Macros tab, select a macro.
8. Select the start time.
9. Select the start date.
10. To repeat the event daily, weekly, or monthly:
 - a) Select the **Recurrence** slider.
 - b) Select the frequency of the recurrence. The options are daily, weekly, or monthly.
 - c) Select the days or months you want the playlist, content, or automation event to play.
 - d) To select an end date for the schedule, select **Calendar**. 
11. To prevent the scheduled event from being overwritten, select the **Lock Event** slider. Locked events cannot be overwritten by pasted events.
12. Select **Create Event**.

Editing a scheduled event

Edit a scheduled event to modify the run time and date.

1. In the left navigation menu, select **Scheduler**.

2. In the calendar view, select the scheduled event.
3. Select **Edit**.
4. Edit the scheduled event settings.
5. Select **Update Event**.

Copying and pasting an existing scheduled event

To run a scheduled event at a different date and time, copy and paste it.

1. In the left navigation menu, select **Scheduler**.
2. In the calendar view, select the scheduled event.
3. Select **Copy**.
4. Select a square below the date and next to the time you want the event to run.
5. Select **Paste**.
6. Adjust the settings for the scheduled event.
7. Select **Paste Event**.

Copying and pasting scheduled events for an entire day

To run an existing full day of scheduled events on a different date, copy and paste the entire day of scheduled events.

1. In the left navigation menu, select **Scheduler**.
2. At the top of the calendar, select the day with the events you want to copy.
3. Select **Copy**.
4. At the top of the calendar, select the new target day.
5. Select **Paste**.
Only unlocked events are copied to the new day.

Cutting and pasting a scheduled event

To move an existing scheduled event to a different date and time, cut and paste it.

1. In the left navigation menu, select **Scheduler**.
2. In the calendar view, select the scheduled event.
3. Select **Cut**.
4. Select the new date in the calendar.
5. Select **Paste**.
6. Adjust the settings for the scheduled event.

7. Select **Paste Event**.
Only unlocked events are copied.

Deleting a scheduled event

Delete an individual scheduled event when it is no longer required.

1. In the left navigation menu, select **Scheduler**.
2. In the calendar view, select the scheduled event.
3. Select **Delete**.
4. To confirm the deletion, select **Delete**.

Deleting scheduled events for an entire day

Delete the scheduled events for an entire day when they are no longer required.

1. In the left navigation menu, select **Scheduler**.
2. At the top of the calendar, select the target day.
3. Select **Clear Day**.
4. To confirm the change, select **Clear Day**.

Changing the day of the week the scheduler starts

Change the start day of the scheduler to match the schedule of the theater.

1. In the left navigation menu, select **Service Setup > Preferences**.
2. Select **General**.
3. In the Scheduler area, select the day of the week to start the scheduler.

Turning off the scheduler

Turn off the scheduler when you do not want scheduled events to run automatically on a specific date and time.

1. In the left navigation menu, select **Scheduler**.
2. To disable scheduled events, move the **Scheduler is on** slider to the left.
The color of the slider changes to grey to indicate it is inactive.

Automation

Use automation to control playback, the projector, and external devices.

- **Macros**—A macro is a list of actions you define. For example, opening the curtains or turning on the house lights at the end of playback. A macro can be activated by a global trigger or it can be added to a playlist.
- **Device Input Triggers**—Input cues wait for events, such as a general purpose input (GPI) state change or an Ethernet message received on the projector management IP address port 5111. An input cue in a playlist delays playback until an event occurs.
- **Global Triggers**—A global trigger combines an input cue with a macro. When the predefined event for the input cue occurs, the output macro is triggered. For example, a fire alarm input signal could cause playback to stop and the house lights to come on. A global trigger is always active and is not dependent on specific playlist definitions.

On CP4450-RGB projectors, playback automation is controlled through the GDC Integrated Media Block (IMB). For more information, refer to the documentation provided with your IMB device.

On CP44xx-RGB projectors, the GDC IMB automation cue *ON_Projector* does not function in Standby mode. To automate your show, first use the Scheduler to power on the IMB.

Available macro actions

The following macro actions are available to control automated events.

Action item	Available actions	Description
Automation	Set Global	Sets a global variable to be used in automation scripting (intended for advanced scripting by Christie).
	Print	Generates a projector log entry when an automation macro runs.
	Get Global	Allows the automation script to read the value of a global variable (intended for advanced scripting by Christie).
	Set GPO	Sets the specified GPO pin to high or low.
	Pulse GPO	Pulses the specified GPO pin.
	Get GPI	Allows an automation script to read the GPI state (intended for advanced scripting by Christie).
	Delay	Delays macro execution.
	Wait On GPI	Pauses the automation script and waits for the specified GPI event to enter the specified state.
Playback*	Pause	Pauses playback.
	Stop	Stops playback.
	Play	Starts or resumes playback.

Action item	Available actions	Description
	Toggle	Pauses playback if content is playing or resumes playback if content is paused.
	Jog	Moves content forward by the time specified.
Projector	Douser Open	Opens the douser (shutter).
	Douser Close	Closes the douser (shutter).
	Light On	Turns the light on.
	Light Off	Turns the light off.
	Standby	Puts the projector in standby mode.
	Channel	Selects a specific projector channel.
	Revert Warp File	Reverts the active warp file to its previous setting.
	Full Power	Places the projector in full power mode.
	Wait	Delays the execution of a macro.

* Available when the IMB-S4 is installed.

Fire alarm macro

By default, the projector is configured with a macro using a building fire alarm as the trigger.

If the projector is connected the building's fire alarm system (recommended installation), the default `FIRE_ALARM` macro puts the projector into Standby mode if a fire alarm occurs.

You can also create a custom macro that uses the fire alarm trigger or edit the default fire alarm macro to perform other actions as needed.

Christie ACT actions

The following built-in commands are available for Christie ACT.

Command	Description
Buzzer	Activates the buzzer for the specified time (in milliseconds).
Button	Simulates pressing or holding the ACT button.
Pulse Relay	Sends a pulse to a specific relay.
Open Relay	Opens a specific relay.
Close Relay	Closes a specific relay.
Pulse GPO	Sends a pulse to a specific GPO pin.
Set All GPOs	Sets the values for all GPO pins.
Run Script	Runs a script on the Christie ACT.
Flash LED	Causes a specific LED to flash.

Command	Description
Set All LEDs	Sets values for all of the LEDs.

JNIOR actions

The following built-in commands are available for JNIOR devices.

Command	Description
Open Relay	Opens a specific JNIOR relay
Close Relay	Closes a specific JNIOR relay
Pulse Relay	Sends a pulse to a specific JNIOR relay for the specified time (in milliseconds)
Execute Macro	Executes a JNIOR macro

Christie provides three JNIOR libraries.

Christie library	Relay outputs	JNIOR model supported
JNIOR	8	JNIOR 310, JNIOR 410
JNIORx12	12	JNIOR 312, JNIOR 412
JNIORx16	16	JNIOR 412 with a 4-relay output expansion model

Note the following:

- You can create macros on the JNIOR device and call them using the `Execute Macro` command. Make sure you use `\\0D` for a carriage return and `\\0A` for a line feed. To create and run macros on the JNIOR, use the JNIOR Support Tool to enable and configure the Cinema.JNIOR application. For additional information, see INTEG Process Group (<https://jnior.com>). Port 9200 is the default Ethernet port for sending automation commands to the JNIOR.
- The jnior login must be disabled on the JNIOR device and the jnior username and password removed in the Christie software to allow the cues to pass over the network.

Dolby cinema processor actions

The following built-in commands are available for Dolby CP650, CP750, CP850, CP950, and CP950A devices:

Command	Description
Mute On/Mute Off	Enables or disables muting.
Set Format (CP650 only)	Selects the format.
Set Fader Level	Sets the fader level.
Send Message	Sends the specified message.

If you need to control additional functions and a built-in command is not available, send a command string in a macro. For example, send this command to enable surround boost on the Dolby CP750:
`cp750.sys.surround_boost 1\\0D`

Make sure you include a carriage return (\\0D) at the end of each command. For more information about controlling other features with serial commands, see the Dolby CP750 documentation.

The default Ethernet port for sending automation commands to the Dolby CP650 is port 61412. For Dolby CP750, CP850, CP950, and CP950A, the default Ethernet port is port 61408.

SKA-3D actions

The following built-in commands are available for SKA-3D devices:

Command	Description
Set Audio Input Channel	Sets the audio input channel.
Mute On/Mute Off	Enables or disables muting.
Set Main Volume	Sets the overall volume for the system.
Set Video Input Channel	Sets the video input channel.
Active Trigger Input	Controls eight SKA-3D presets. To use this command, a trigger input must be associated with each of the SKA-3D presets.

Creating a macro

Create a macro to make the projector perform a specific list of actions.

1. In the left navigation menu, select **Automation > Macro Editor**.
2. Select **+ Create New Macro**.
3. Enter a name for the macro.
4. Select the macro type.
5. Select **Create**.
6. Add an action item to the macro:
 - a) In the right pane, select **+**.
 - b) In the Add New Action Item dialog, select My Auditorium.
 - c) Under Automation or Projector, select an action item.
7. Select **Create**.
8. To save the macro, select **Save**.
9. To test the macro, select **Test**.

Running a macro

Run a macro to have the projector perform a specific list of actions.

1. In the right pane, select **Macro Selection**. 
2. Select a macro.

Adding an action item to an existing macro

Add an action item to a macro to have the projector perform an additional action when the macro runs.

1. In the left navigation menu, select **Automation > Macro Editor**.
2. In the left pane, select a macro from the list.
3. Add an action item to the macro:
 - a) In the right pane, select **+**.
 - b) Under Automation, Playback, or Projector, select the action item.
4. Select **Create**.
5. To save the macro, select **Save**.
6. To test the macro, select **Test**.

Adding a macro to an existing macro

Combine macros to have the projector complete a complex set of actions.

1. In the left navigation menu, select **Automation > Macro Editor**.
2. In the left pane, select a macro.
3. In the right pane, select **+**.
4. In the Add New Action Item dialog, select **Macros**.
5. Select a macro.
6. Select **Create**.
7. To save the macro, select **Save**.
8. To test the macro, select **Test**.

Renaming an existing macro

Learn how to rename an existing macro.

1. In the left navigation menu, select **Automation > Macro Editor**.
2. In the left pane, select the existing macro to rename.
3. Select **Edit**.
4. In the Confirmation dialog, select one of the following:

- Continue—Select this option to proceed with renaming and continue to step 5.
 - Cancel—Select this option to terminate the action.
5. In the Edit Macro dialog, enter the new name for the macro.
 6. Select **Save**.

Deleting a macro

Delete macros when they are no longer required.

1. In the left navigation menu, select **Automation > Macro Editor**.
2. In the left pane, select a macro.
3. Select **Delete**. 
4. To confirm the deletion, select **Delete**.

Enabling press and hold function

When enabled, the press and hold action is required to execute any macro.

This functionality is disabled by default.

Installer or Service role levels are required to perform this procedure.

1. In the right pane, select **Macro Selection**. 
2. Select **Enable Press and Hold**.

Adding an automation device to your auditorium

Add an automation device so it can be controlled remotely and can communicate with other theater hardware.

1. In the left navigation menu, select **Automation > My Auditorium Devices**.
2. Select **+ New Device**.
3. In the Name field, enter a name for the device.
The Name field cannot contain spaces.
4. In the Device Type list, select the device type.
5. In the Select Device list, select the device.
6. Select **Add**.
7. Complete these fields:
 - **IP Address**—The IP address of the automation device.
 - **Port**—The port used by the automation device to communicate with the projector.
 - **Username**—The username used to access the automation device.
 - **Password**—The password used to access the automation device.

- **Keep Alive Message**—The message value sent to the automation device to make sure the projector is not disconnected when inactive.
 - **Keep Alive Interval (ms)**—The time interval (in milliseconds) for sending the Keep Alive Message to the automation device.
8. Select **Save**.
The added device is displayed in the list of auditorium devices in the Macro Editor.

Disabling automation warnings

Learn how to disable automation warning alarm dialogs.

Automation warnings are enabled by default and whenever a factory reset is performed.

1. In the left navigation menu, select **Service Setup > Preferences**.
2. Select **Alarm Triggers**.
3. To disable automation warnings, toggle off **Automation Warnings**.

Modifying automation device settings

Modify the settings of automation devices when parameters such as the username or password change. If the settings are not updated, the automation device might not be able to communicate with other theater hardware or be controlled remotely.

1. In the left navigation menu, select **Automation > My Auditorium Devices**.
2. In the left pane, select an automation device.
3. Modify these fields:
 - **IP Address**—The IP address of the automation device.
 - **Port**—The port used by the automation device to communicate with the projector.
 - **Username**—The username used to access the automation device.
 - **Password**—The password used to access the automation device.
 - **Keep Alive Message**—The message value sent to the automation device to make sure the projector is not disconnected when inactive.
 - **Keep Alive Interval (ms)**—The time interval (in milliseconds) for sending the Keep Alive Message to the automation device.
4. Select **Save**.

Removing an automation device from your auditorium

Remove an automation device when it is no longer required, or it has been physically removed from the theater.

1. In the left navigation menu, select **Automation > My Auditorium Devices**.
2. In the left pane, select an automation device.

3. Select **Delete**.
4. To confirm the deletion, select **Delete**.

Creating, editing, and deleting playlist triggers

Playlist triggers are configured and managed through the Integrated Media Block (IMB).

For more information, refer to the documentation provided with your IMB device.

Creating a new global trigger

Create a global trigger to trigger an output macro. For example, a fire alarm input signal could cause playback to stop and the house lights to come on. A global trigger is always active and is not dependent on specific playlist definitions.

1. In the left navigation menu, select **Automation > Device Input Triggers**.
2. Select **+ New Global Trigger**.
3. Complete the Name, Source, and Trigger Event fields.
The Name field cannot contain spaces.
4. In the Macro Name list, select the macro that will run on trigger detection.
5. Select **Add**.

Editing existing global trigger settings

Edit the settings of an existing global trigger to change its behavior.

1. In the left navigation menu, select **Automation > Device Input Triggers**.
2. To the right of the global trigger you want to edit, select **Edit**.
3. Edit the global trigger settings.
4. Select **Save**.

Deleting a global trigger

Delete a global trigger when it is no longer required.

1. In the left navigation menu, select **Automation > Device Input Triggers**.
2. To the right of the global trigger, select **Delete**.
3. To confirm the deletion, select **Delete**.

Importing a device library

A device library contains commands used to control a specific device.

1. In the left navigation menu, select **Automation > Device Libraries**.
2. Select **Import Device Library**.
3. Browse to the location of the device library file.

4. Select the file and select **Open**.

Viewing a device library

View device libraries to determine if a library exists for the network device.

1. If the device library is not in the list, import it.
2. In the left navigation menu, select **Automation > Device Libraries**.
3. To the right of the device in the View Library column, select **View Library**.
Review the list of actions available for the device.
4. To exit the dialog, select **OK**.

Deleting a device library

Delete a device library when it is no longer required.

1. In the left navigation menu, select **Automation > Device Libraries**.
2. To the right of the device library, select **Delete**.
3. To confirm the deletion, select **Delete**.

Rental mode

Rental Mode licenses are applied to the projector and control the operation of the projector. Rental Mode supports all CineLife+ projectors. The Brightness Restriction functionality is only available for CineLife+™ projectors running v1.3.0 or later.

Applying a rental mode license file

If your projector is a rental unit provided by a vendor, you must apply a rental license to enable certain features.

1. Save the license file in one of the following ways.
 - Using the touch panel control—Save the file to a USB flash drive.
 - Using the web user interface—Save the file to a location on your computer.
2. If using the touch panel control, insert the USB flash drive in the USB port on the projector faceplate.
3. In the right toolbar, select **Rental Mode**. 
4. In the Rental Licenses window, select **Import License**.
5. In the Open File dialog, navigate to the folder containing the license ZIP file and select the file from the list.
6. Select **Open**.
The system displays the rental licenses information.

Viewing rental mode license expiry

View the days remaining and expiry date of the applied rental license.

1. In the right toolbar, select **Rental Mode**. 
2. In the Rental Licenses window, view the following information:
 - Days remaining
 - Expiry date

When a license is nearing expiration, the license information box changes color and the system displays an alert on the Rental Mode icon. 

Warning/alarm	Threshold
Hours warning	140 hours (14 days @ 10 hours/day)
Hours alarm	30 hours (3 days @ 10 hours/day)
Duration warning	14 days

Warning/alarm	Threshold
Duration alarm	3 days

Backing up, restoring, and upgrading files

Learn how to back up, restore, and upgrade projector files.

Creating a new backup file

Create a new backup file to restore projector settings if a failure occurs.

1. In the left navigation menu, select **Service Setup** > **Backup and Restore**.
2. Select **New Backup**.
3. Enter a name for the backup file and select **Backup**.

Downloading a backup file

A disaster recovery plan can include exporting backup files to another location.

1. In the left navigation menu, select **Service Setup** > **Backup and Restore**.
2. If using the web user interface (UI), select a backup file and select **Download**.
The file automatically downloads to the computer's Downloads folder.
3. If using the touch panel control, insert a USB flash drive into the **USB** port on the projector faceplate.
4. Select a backup file and select **Download**.
5. Select  to move up through the file directory.
6. In the Name field, enter a name for the backup file.
7. Select **Accept**.

Importing a backup file

Import a backup file to restore projector settings.

1. In the left navigation menu, select **Service Setup** > **Backup and Restore**.
2. If using the touch panel control, insert a USB flash drive into the **USB** port on the projector faceplate.
3. Select **Import Backup**.
4. Browse to the location of the file or enter a name for the backup file in the Name field.
5. Select the file and select **Open**.

6. If the file already exists, in the confirmation dialog select **Overwrite**.

Sorting backup files by name and date created

Locate a backup file with a specific name or creation date.

1. In the left navigation menu, select **Service Setup > Backup and Restore**.
2. Sort the backup files:
 - To sort the backup files by name, select the **Backup File Name** heading.
 - To sort the files by the date they were created, select the **Date Created** heading.

Deleting a backup file

Delete a backup file if it is no longer required or is uploaded in error.

1. In the left navigation menu, select **Service Setup > Backup and Restore**.
2. Select a backup file and select **Delete** .
3. To confirm, select **Delete**.

Restoring settings from a backup file

Restore projector settings from a backup file.

1. In the left navigation menu, select **Service Setup > Backup and Restore**.
2. Select a backup file and select **Restore**.
3. Select the settings you want to restore and select **Restore**.
4. When the restore is complete, select **OK**.

Restoring factory default settings

Restoring factory settings removes all custom projector settings.

1. In the left navigation menu, select **Service Setup > Backup and Restore**.
2. Select **Factory Restore**.
3. Select the settings you want to restore and select **Restore**.
4. Select **OK**.

Upgrading the projector software

An upgrade package is used to upgrade the projector software to the latest version. The upgrade package is installed from a USB key, the projector's `ftpuser` directory, or from your computer.

To obtain the upgrade package, contact Christie Technical support. Christie recommends backing up your files before installing an upgrade package.

1. Power on the projector and place it in Standby mode.
2. Upload the required upgrade package using one of the following methods:
 - Using the touch panel—Upload the required upgrade package to a USB key or navigate to the projector's `ftpuser` directory.



NTFS-formatted USB drives are not supported for this release.

- Using the web user interface (UI)—Upload the required upgrade package to your computer.
3. If using the USB method, insert the USB key into the projector.
 4. In the left navigation menu, select **Service Setup > System Upgrade**.
The available upgrade packages are displayed on screen.
 5. If you uploaded the upgrade package to your computer, select **+ New Upgrade File**.
 6. Select the upgrade package file from the list.
 7. Select **Open**.
 8. In the right pane, navigate to the upgrade file and select **Upgrade**.
 9. To begin the upgrade, select **Upgrade** in the confirmation dialog.
The projector restarts automatically when the upgrade is complete.

Accessing projector diagnostics

Learn how to access projector system logs and run diagnostic utilities.

Retrieving and downloading system logs

System logs can aid with the identification and correction of projector faults.

1. In the left navigation menu, select **Diagnostics > System Logs/Interrogator**.
2. In the From list, select a start date for the logs.
3. In the To list, select an end date for the logs.
4. Select **Search Logs**.
5. To sort log files by type, message, or date, select a column heading.

Running the projector interrogator

Run the interrogator to identify and correct projector faults.

1. If using the touch panel control, insert a USB flash drive into the **USB** port on the projector faceplate.
2. In the left navigation menu, select **Diagnostics > System Logs/Interrogator**.
3. Select **Run Interrogator**.
4. In the confirmation dialog, select **Interrogate**.

By default, the interrogator excludes the following to limit the size of the log file output:

- Warp files
- LOS data (for warranty purposes)
- Cinema sensor files beyond the 5 most recent
- Core snapshots beyond the 5 most recent
- Core dump files when a crash occurs
- Test patterns

To include the above files in the interrogator log, select the option for **Enhanced**. Including these files significantly increases the size of the interrogator log file (ZIP).

5. If using the web user interface, in the Interrogator dialog, select **Download File**.
6. If using the touch panel control, browse to the location where you want the interrogator file to be saved.
7. In the Name field, enter a name for the interrogator file.

8. Select **Accept**.

Viewing laser diagnostic information

Find diagnostic information on the laser optical subsystems (LOS).

1. In the left navigation menu, select **Laser Settings > Laser Diagnostics**.
2. Review the detailed information for the following:
 - Model
 - Version
 - Serial numbers
 - Power health
 - Drivers
 - Temperature

Downloading a certificate

Follow these steps to download a required certificate.

1. If using the touch panel control, insert a USB flash drive into the **USB** port on the projector faceplate.
2. In the left navigation menu, select **About**.
3. Select a certificate type.
4. Select **Download**.
If using the web user interface, the certificate automatically downloads to your computer's Downloads folder.
5. If using the touch panel control, browse to the location where you want to save the certificate.
6. Select **Accept**.

Regulatory

This product conforms to the latest regulations and standards related to product safety, environmental, and electromagnetic compatibility (EMC) requirements.

Safety

- ANSI/UL 60950-1 – Information Technology Equipment – Safety – Part 1: General Requirements
- CAN/CSA C22.2 No. 60950-1-07 – Information Technology Equipment – Safety – Part 1: General Requirements
- IEC/EN 60825-1 – Safety of Laser Products – Part 1: Equipment Classification and Requirements
- IEC 60950-1 IEC/EN 60950-1 – Information Technology Equipment – Safety – Part 1: General Requirements
- IEC/EN 62471-5 – Photobiological Safety of Lamps and Lamp Systems – Part 5: Image projectors

Electro-magnetic compatibility

Emissions

- CAN ICES-003 (A)/NMB-003 (A) – Information Technology Equipment (Including Digital Apparatus) – Limits and Methods of Measurement
- CISPR 32/EN 55032, Class A – Electromagnetic Compatibility of Multimedia Equipment – Emission Requirements
- FCC CFR47, Part 15, Subpart B, Class A – Unintentional Radiators
- IEC 61000-3-2/EN61000-3-2: Limits for harmonic current emissions for equipment with input current ≤ 16 A
- IEC 61000-3-3/EN61000-3-3: Limitations of Voltage Changes, Voltage Fluctuations, and Flicker input current ≤ 16 A
- IEC 61000-3-11/EN61000-3-11: Limitations of Voltage Changes, Voltage Fluctuations, and Flicker for equipment with rated current ≤ 75 A
- IEC 61000-3-12/EN61000-3-12: Limits for harmonic current emissions for equipment for systems with input current > 16 A and ≤ 75 A per phase

Immunity

- CISPR 24/EN55024 EMC Requirements – Information Technology Equipment

Environmental

- China Ministry of Information Industry (along with 7 other Government Agencies) Order No.32 (01/2016) on the control of pollution caused by electronic information products, hazardous substances concentration limits (GB/T 26572 - 2011), and the applicable product marking requirement (SJ/T 11364 - 2014).
- EU Directive (2011/65/EU) on the restriction of the uses of certain hazardous substances (RoHS) in electrical and electronic equipment and the applicable official amendment(s).
- EU Directive (2012/19/EU) on waste and electrical and electronic equipment (WEEE) and the applicable official amendment(s).
- Regulation (EC) No. 1907/2006 on the registration, evaluation, authorization and restriction of chemicals (REACH) and the applicable official amendment(s).