

User Guide
020-102712-06

Cinema 4K-RGB

CP4315-RGB, CP4320-RGB, CP4325-RGB, CP4330-
RGB

CHRISTIE®

NOTICES

COPYRIGHT AND TRADEMARKS

Copyright © 2021 Christie Digital Systems USA Inc. All rights reserved.

All brand names and product names are trademarks, registered trademarks or trade names of their respective holders.

GENERAL

Every effort has been made to ensure accuracy, however in some cases changes in the products or availability could occur which may not be reflected in this document. Christie reserves the right to make changes to specifications at any time without notice. Performance specifications are typical, but may vary depending on conditions beyond Christie's control such as maintenance of the product in proper working conditions. Performance specifications are based on information available at the time of printing. Christie makes no warranty of any kind with regard to this material, including, but not limited to, implied warranties of fitness for a particular purpose. Christie will not be liable for errors contained herein or for incidental or consequential damages in connection with the performance or use of this material. Manufacturing facilities in Canada and China are ISO 9001 certified.

Warranty

Products are warranted under Christie's standard limited warranty, the details of which are available at <https://www.christiedigital.com/help-center/warranties/> or by contacting your Christie dealer or Christie.

PREVENTATIVE MAINTENANCE

Preventative maintenance is an important part of the continued and proper operation of your product. Failure to perform maintenance as required, and in accordance with the maintenance schedule specified by Christie, will void the warranty. For preventative maintenance schedules, refer to www.christiedigital.com.

REGULATORY

The product has been tested and found to comply with the limits for a Class A digital device, pursuant to Part 15 of the FCC Rules. These limits are designed to provide reasonable protection against harmful interference when the product is operated in a commercial environment. The product generates, uses, and can radiate radio frequency energy and, if not installed and used in accordance with the instruction manual, may cause harmful interference to radio communications. Operation of the product in a residential area is likely to cause harmful interference in which case the user will be required to correct the interference at the user's own expense. Changes or modifications not expressly approved by the party responsible for compliance could void the user's authority to operate the equipment

CAN ICES-3 (A) / NMB-3 (A)

이 기기는 업무용(A급)으로 전자파적합등록을 한 기기이오니 판매자 또는 사용자는 이점을 주의하시기 바라며, 가정 외의 지역에서 사용하는 것을 목적으로 합니다.

ENVIRONMENTAL

The product is designed and manufactured with high-quality materials and components that can be recycled and reused. This symbol  means that electrical and electronic equipment, at their end-of-life, should be disposed of separately from regular waste. Please dispose of the product appropriately and according to local regulations. In the European Union, there are separate collection systems for used electrical and electronic products. Please help us to conserve the environment we live in!

Content

Safety precautions.	10
General safety precautions.	10
Laser safety precautions.	10
AC power precautions.	11
Light intensity hazard distance.	11
Product labels.	13
General hazards.	13
Mandatory action.	14
Electrical labels.	14
Additional hazard labels.	15
Introduction.	16
Product documentation.	16
Related documentation.	17
Projector overview.	17
Contact your dealer.	17
Key features.	18
Understanding the Christie touch panel interface and remote user interface.	18
Using the Remote UI.	19
Technical support.	20
Operating the projector.	21
Projector power modes.	21
Turning the projector on or off.	21
Logging on to the projector.	21
Logging out of the projector.	22
Turning the touch panel on or off.	22
Calibrating the touch panel display.	22
Turning the light source on or off.	22
Opening or closing the shutter.	23
Selecting the active channel.	23
Adding a network time protocol server.	23
Deleting a network time protocol server.	24
Changing the time zone.	24

Changing the time format.	24
Automatically adjusting the time for Daylight Saving Time.	24
Manually adjusting the time offset.	25
Changing the orientation of the projected image.	25
Changing the projector host name.	26
Changing the temperature display.	26
Managing the light source.	27
Creating a new laser file.	27
Modifying an existing laser file.	29
Copying existing laser settings to a new file.	29
Deleting a laser file.	29
Managing user accounts.	30
Default user access permissions.	30
Adding a user account.	30
Changing user account permissions.	30
Changing a user account password.	31
Deleting a user account.	31
Network settings.	32
Connecting the projector to the theater network.	32
Connecting the projector to network attached storage.	32
Connecting the projector to a media or content network.	33
Activating SNMP.	33
Downloading MIB information.	33
Setting up an integrated media block.	35
Selecting IMB preferences.	35
Activating IMB marriage.	35
Managing content.	37
Content manager icons.	37
Ingesting content and keys.	37
Canceling an ingest.	38
Viewing remaining NAS storage capacity.	38
Filtering content by type.	38
Viewing available keys.	38
Filtering the key list.	38
Deleting local content.	39

Deleting keys.	39
Collapsing or expanding columns.	39
Viewing content details.	39
Loading and playing content.	40
Unloading content.	40
Managing playlists.	41
Creating a new playlist.	41
Reordering playlist content.	41
Adding a time offset to a macro.	42
Replacing playlist content.	42
Removing playlist content.	42
Copying a playlist.	43
Opening an intermission playlist.	43
Viewing details about playlist content.	43
Importing a playlist.	43
Exporting a playlist.	44
Deleting a playlist.	44
Working with channels.	45
Adding a channel for HDMI input.	45
Adding a channel for IMB input.	46
Editing an existing channel.	47
Copying existing channel settings to a new channel.	47
Viewing the channel list.	48
Moving a channel up or down the channel list.	48
Deleting a channel.	48
Managing color setting files.	49
Creating a MCGD file.	49
Editing an existing MCGD file.	49
Copying existing MCGD file settings to a new file.	50
Deleting a MCGD file.	50
Creating a TCGD file.	50
Editing an existing TCGD file.	51
Copying existing TCGD file settings to a new file.	51
Deleting a TCGD file.	51
Adjusting the image size and position.	52

Activating the Intelligent Lens System.	52
Creating a new ILS file.	52
Automatically calibrating the ILS.	52
Editing ILS file settings.	53
Copying existing ILS file settings.	53
Deleting an ILS file.	53
Resetting the lens.	53
Creating a source file.	53
Editing source file settings.	54
Copying existing source file settings to a new source file.	54
Deleting a source file.	54
Creating a screen file.	55
Editing screen file settings.	55
Copying existing screen file settings to a new screen.	56
Deleting a screen file.	56
Performing digital convergence.	56
Resetting digital convergence to the default settings.	57
Adjusting the image.	58
Correcting vignetting.	58
Correcting keystone effect.	58
Adjusting the integrator rod and fold mirror.	59
Adjusting the boresight.	62
Adjusting DMD convergence.	64
Masking the screen edges.	66
Test patterns.	68
Displaying a test pattern.	68
Turning off a test pattern.	68
Importing a test pattern.	69
Deleting a test pattern.	69
Working with the scheduler.	70
Scheduling a playlist, content, or automation.	70
Editing a scheduled event.	71
Copying and pasting an existing scheduled event.	71
Copying and pasting scheduled events for an entire day.	71
Cutting and pasting a scheduled event.	71
Deleting a scheduled event.	72

Deleting scheduled events for an entire day. 72

Changing the day of the week the scheduler starts. 72

Turning the scheduler off. 72

Managing storage devices. 73

 Adding a new storage device. 73

 Editing storage device settings. 73

 Setting a storage device as a primary drive. 73

 Deleting a storage device. 74

 Adding a remote ingest source. 74

 Editing remote ingest source settings. 74

 Deleting a remote ingest source. 75

Managing projector setting files. 76

 Creating a 3D file. 76

 Editing an existing 3D file. 76

 Copying a 3D file. 77

 Deleting a 3D file. 77

Managing audio settings. 78

 Setting the global audio delay. 78

 Setting the audio output rate. 78

 Mapping channels. 78

 Enabling Dolby Atmos. 79

 Editing Dolby Atmos settings. 79

 Disabling Dolby Atmos. 79

Setting up multiple projectors. 80

 Enabling multiple projectors. 80

 Adding a secondary projector. 80

 Disabling multiple projectors. 81

 Disabling a secondary projector. 81

 Deleting a secondary projector. 81

Automation. 82

 Available macro actions. 82

 Fire alarm macro. 83

 Christie ACT actions. 83

 JNIOR actions. 84

 Dolby Cinema processor actions. 84

SKA-3D actions.	85
Creating a macro.	85
Running a macro.	85
Adding an action item to an existing macro.	86
Adding a macro to an existing macro.	86
Deleting a macro.	86
Adding an automation device to your auditorium.	86
Modifying automation device settings.	87
Removing an automation device from your auditorium.	87
Creating a new playlist trigger.	88
Editing existing playlist trigger settings.	88
Deleting a playlist trigger.	88
Creating a new global trigger.	88
Editing existing global trigger settings.	89
Deleting a global trigger.	89
Importing a device library.	89
Viewing a device library.	89
Deleting a device library.	90
Enhancements and licensing.	91
Enabling an enhancement.	91
Enabling RealD 3D EQ.	91
Importing a rental license file.	91
Backing up, restoring, and upgrading files.	93
Creating a new backup file.	93
Exporting a backup file.	93
Importing a backup file.	93
Sorting backup files by name and date created.	94
Deleting a backup file.	94
Adding an upgrade package.	94
Installing an upgrade package.	94
Comparing upgrade packages.	95
Deleting an upgrade package.	95
Restoring settings from a backup file.	95
Restoring factory default settings.	95
Accessing projector diagnostics.	96
Retrieving and downloading system logs.	96

Running the projector interrogator.	96
Viewing laser diagnostic information.	97
Downloading a certificate.	97
Regulatory.	98
Safety.	98
Electro-magnetic compatibility.	98
Emissions.	98
Immunity.	98
Environmental.	99

Safety precautions

Learn about the safety precautions related to the Christie Cinema 4K-RGB projector. This projector is intended for use in a cinema environment.

General safety precautions

Read all safety and warning guidelines before installing or operating the projector.



Warning! If not avoided, the following could result in death or serious injury.

- TRIP OR FIRE HAZARD! Position all cables where they cannot contact hot surfaces, be pulled, be tripped over, or damaged by persons walking on or objects rolling over the cables.
- This product must be installed within a restricted access location not accessible by the general public.
- Only personnel who are trained on the precautions for the restricted access location can be granted entry to the area.
- Install the product so users and the audience cannot enter the restricted area at eye level.
- ELECTRICAL and BURN HAZARD! Use caution when accessing internal components.
- High leakage current present when connected to IT power systems.
- FIRE AND SHOCK HAZARD! Use only the attachments, accessories, tools, and replacement parts specified by Christie.
- FIRE HAZARD! Do not use a power cord, harness, or cable that appears damaged.
- A minimum of four people or appropriately rated lift equipment is required to safely lift, install, or move the product.
- Do not install or operate the projector in any position that does not meet the stated product specifications for alignment and orientation.



Caution! If not avoided, the following could result in minor or moderate injury.

- Only Christie qualified technicians are permitted to open product enclosures.

Laser safety precautions

Read all safety and warning guidelines before operating the projector laser.



Warning! If not avoided, the following could result in death or serious injury.

- Do not operate the cinema projector without all of its covers in place.
- LASER RADIATION HAZARD! This projector has a built-in Class 4 laser module. Never attempt to disassemble or modify the laser module.
- Do not look directly into the lens when the light source is on. The extremely high brightness can cause permanent eye damage.
- Possible hazardous optical radiation emitted from this product. (Risk group 3)

AC power precautions

Read all safety and warning guidelines before connecting to AC power.



Warning! If not avoided, the following could result in death or serious injury.

- SHOCK HAZARD! Only use the AC power cord provided with the product or recommended by Christie.
- FIRE AND SHOCK HAZARD! Do not attempt operation unless the power cord, power socket, and power plug meet the appropriate local rating standards.
- SHOCK HAZARD! Do not attempt operation if the AC supply is not within the specified voltage and current, as specified on the license label.
- SHOCK HAZARD! The optional UPS power cord must be inserted into an outlet with grounding.
- SHOCK HAZARD! A dedicated, protected ground or earth wire must be installed on the product by Christie qualified technicians or electricians before it can be connected to power.
- SHOCK HAZARD! Disconnect the product from AC before installing, moving, servicing, cleaning, removing components, or opening any enclosure.
- Install the product near an easily accessible AC receptacle.



Caution! If not avoided, the following could result in minor or moderate injury.

- FIRE HAZARD! Do not use a power cord, harness, or cable that appears damaged.
- FIRE OR SHOCK HAZARD! Do not overload power outlets and extension cords.
- SHOCK HAZARD! Power supply uses double pole/neutral fusing.

Light intensity hazard distance

This projector has been classified as Risk Group 3 as per the IEC 62471-5:2015 standard due to possible hazardous optical and thermal radiation being emitted.



Warning! If not avoided, the following could result in serious injury.

- PERMANENT/TEMPORARY BLINDNESS HAZARD! No direct exposure to the beam must be permitted. Class 1 Laser Product - Risk Group 3 according to IEC 60825-1:2014 and IEC 62471-5:2015.
- PERMANENT/TEMPORARY BLINDNESS HAZARD! Operators must control access to the beam within the hazard distance or install the product at the height that prevents exposure of spectators' eyes within the hazard distance. The hazard zone must be no lower than 2.5 meters (US installations) or 2.0 meters (global installations) above any surface upon which any persons are permitted to stand and the horizontal clearance to the hazard zone must be a minimum 1.0 meters.
- EXTREME BRIGHTNESS! Do not place reflective objects in the product light path.

The following show the zones for ocular and skin hazard distances.

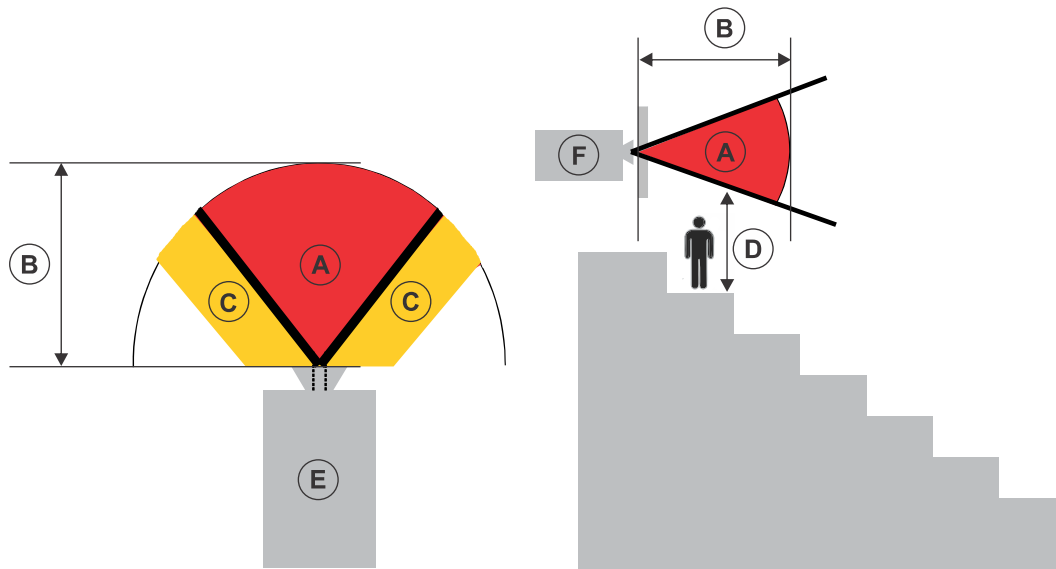

- A—Hazard zone. The region of space where the projection light from the laser-illuminated projector is above emission limits for Risk Group 2. The light intensity may cause eye damage after a momentary or brief exposure (before a person can avert his or her eyes away from the light source). The light may cause skin burns to occur.
- B—Hazard distance. Operators must control access to the beam within the hazard distance or install the product preventing potential exposure of the spectators' eyes from being in the hazard distance.
- C—No access zone. Horizontal clearance of the no access zone must be a minimum of 1.0 meters.
- D—Vertical distance to hazard zone. The hazard zone must be no lower than 2.5 meters (US installations) or 2.0 meters (global installations) above any surface upon which any persons are permitted to stand.
- E—Represents the top view of the projector.
- F—Represents the side view of the projector.

For information detailing the hazard distance for each lens, refer to the product's *Installation and Setup guide*.

For Installations in the United States

The following must be in place for laser-illuminated projector installations in the United States:



- The projection room shall be clearly identified by the posting of laser warning and restricted access signs, and by restricting entry through physical means. The projection room sign must display the warning "No direct exposure to beam shall be permitted".
- The Christie Laser Projection System Installation Checklist must be fully completed after the installation and sent to lasercompliance@christiedigital.com. A copy can remain on-site. This checklist can be found as a separate document in the accessory box with the manual.
- Certain US states have additional laser regulatory requirements. Contact lasercompliance@christiedigital.com for additional regulatory requirements.

Product labels

Learn about the labels that may be used on the product. Labels on your product may be yellow or black and white.

General hazards

Hazard warnings also apply to accessories once they are installed in a Christie product that is connected to power.

Fire and Shock Hazard	
	<p>To prevent fire or shock hazards, do not expose this product to rain or moisture. Do not alter the power plug, overload the power outlet, or use it with extension cords. Do not remove the product enclosure. Only Christie qualified technicians are authorized to service the product.</p>
Electrical Hazard	
	<p>Risk of electric shock. Do not remove the product enclosure. Only Christie qualified technicians are authorized to service the product.</p>



Warning! If not avoided, the following could result in death or serious injury.



Electric shock hazard. To avoid personal injury, disconnect all power sources before performing maintenance or service.



Electrocution hazard. To avoid personal injury, always disconnect all power sources before performing maintenance or service procedures.



Optical radiation hazard. To avoid personal injury, never look directly at the light source.



Voltage hazard. To avoid personal injury, always disconnect all power sources before performing maintenance or service procedures.



Caution! If not avoided, the following could result in minor or moderate injury.



Hot surface hazard. To avoid personal injury, allow the product to cool for the recommended cool down time before touching or handling for maintenance or service.



Burn hazard. To avoid personal injury, allow the product to cool for the recommended cool down time before handling for maintenance or service.



Moving parts hazard. To avoid personal injury, keep hands clear and loose clothing tied back.



Moving fan blade. To avoid personal injury, keep hands clear and loose clothing tied back. Always disconnect all power sources before performing maintenance or service procedures.



Notice. If not avoided, the following could result in property damage.



General hazard.



Not for household use.

Mandatory action



Consult the service manual.



Disconnect all power sources before performing maintenance or service procedures.

Electrical labels



Indicates the presence of a protective earth ground.



Indicates the presence of an earth ground.

Additional hazard labels



Indicates Class 4 laser radiation when open. Avoid eye or skin exposure to direct or scattered radiation.



CLASS 1 LASER PRODUCT IEC 60825-1:2014

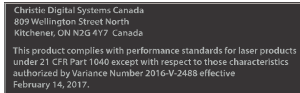

CP4325-RGB FDA laser variance (US projectors only)

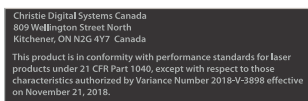

CP4330-RGB FDA laser variance (US projectors only)



Indicates a light hazard. Do not look directly into the lens. The extreme high brightness can cause permanent eye damage. Class 1 Laser Product - Risk Group 3 according to IEC 60825-1:2014 and IEC 62471-5:2015



Indicates high leakage current. Earth connection essential before connecting the power supply.



Indicates a light hazard. Do not look directly into the lens. The extreme high brightness can cause permanent eye damage.

Introduction

This manual is intended for operators of Christie Cinema 4K-RGB projection systems.
For complete production documentation and technical support, go to www.christiedigital.com.

Product documentation

For installation, setup, and user information, see the product documentation available on the Christie website. Read all instructions before using or servicing this product.

1. Access the documentation from the Christie website:

CP4315-RGB

- Go to <https://bit.ly/2JIHhtJ> or <https://www.christiedigital.com/en-us/cinema/cinema-products/digital-cinema-projectors/christie-cp4315-rgb>
- Scan the QR code using a QR code reader app on a smartphone or tablet.

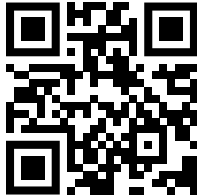

CP4320-RGB

- Go to <https://bit.ly/3n5y11r> or <https://www.christiedigital.com/en-us/cinema/cinema-products/digital-cinema-projectors/christie-cp4320-rgb>
- Scan the QR code using a QR code reader app on a smartphone or tablet.

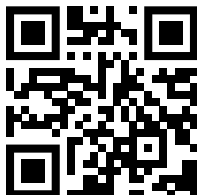

CP4325-RGB

- Go to <http://bit.ly/2BjQLBq> or <https://www.christiedigital.com/en-us/cinema/cinema-products/digital-cinema-projectors/christie-cp4325-rgb>
- Scan the QR code using a QR code reader app on a smartphone or tablet.

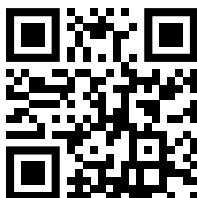

CP4330-RGB

- Go to <https://bit.ly/36PfbWj> or <https://www.christiedigital.com/en-us/cinema/cinema-products/digital-cinema-projectors/christie-cp4330-rgb>
- Scan the QR code using a QR code reader app on a smartphone or tablet.

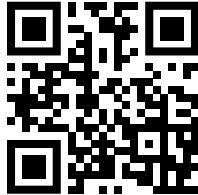

2. Switch to the **Downloads** tab.

Related documentation

Additional information on the projector is available in the following documents.

- *Cinema 4K-RGB Installation and Setup Guide (P/N: 020-102710-XX)*
- *Cinema 4K-RGB Product Safety Guide (P/N: 020-102711-XX)*
- *Cinema 4K-RGB Service Guide (P/N: 020-102713-XX)*
- *CineLife Serial Commands Guide (P/N: 020-102714-XX)*
- *Cinema 4K-RGB Specifications Guide (P/N: 020-102729-XX)*

Projector overview

The Christie Cinema 4K-RGB projectors are medium brightness, RGB laser, digital cinema projectors. The RGB laser optical subassembly is directly coupled to the projector optical path and is housed within the projector chassis.

Contact your dealer

Record the information about your installation and keep this information with your records to assist with any servicing of your product. If you encounter a problem, contact your dealer.

Purchase record
Dealer:
Dealer or Christie Sales/Service contact phone number:
Serial number: The serial number can be found on the license label located on the display panel.
Purchase date:
Installation date:

Key features

Understand the important features of the projector.

- Solid-state Christie ReaLaser™ RGB laser illumination
- Three-chip 1.38 inch 4K DLP™ light engine
- Christie CineLife™ Series 3 electronics
- LiteLOC™ color lock feature for constant image brightness and color
- Direct-coupled laser module integrated in the projector chassis
- Compact form to fit in existing projection booths
- Exhaust air extraction (using optional accessory)

Understanding the Christie touch panel interface and remote user interface

Use the touch panel to control the projector and perform functions such as turning the light on or off, selecting channels, and viewing status information.



The Remote UI is a feature on CineLife projectors for controlling the projector using a web browser. See *Using the Remote UI* (on page 19).

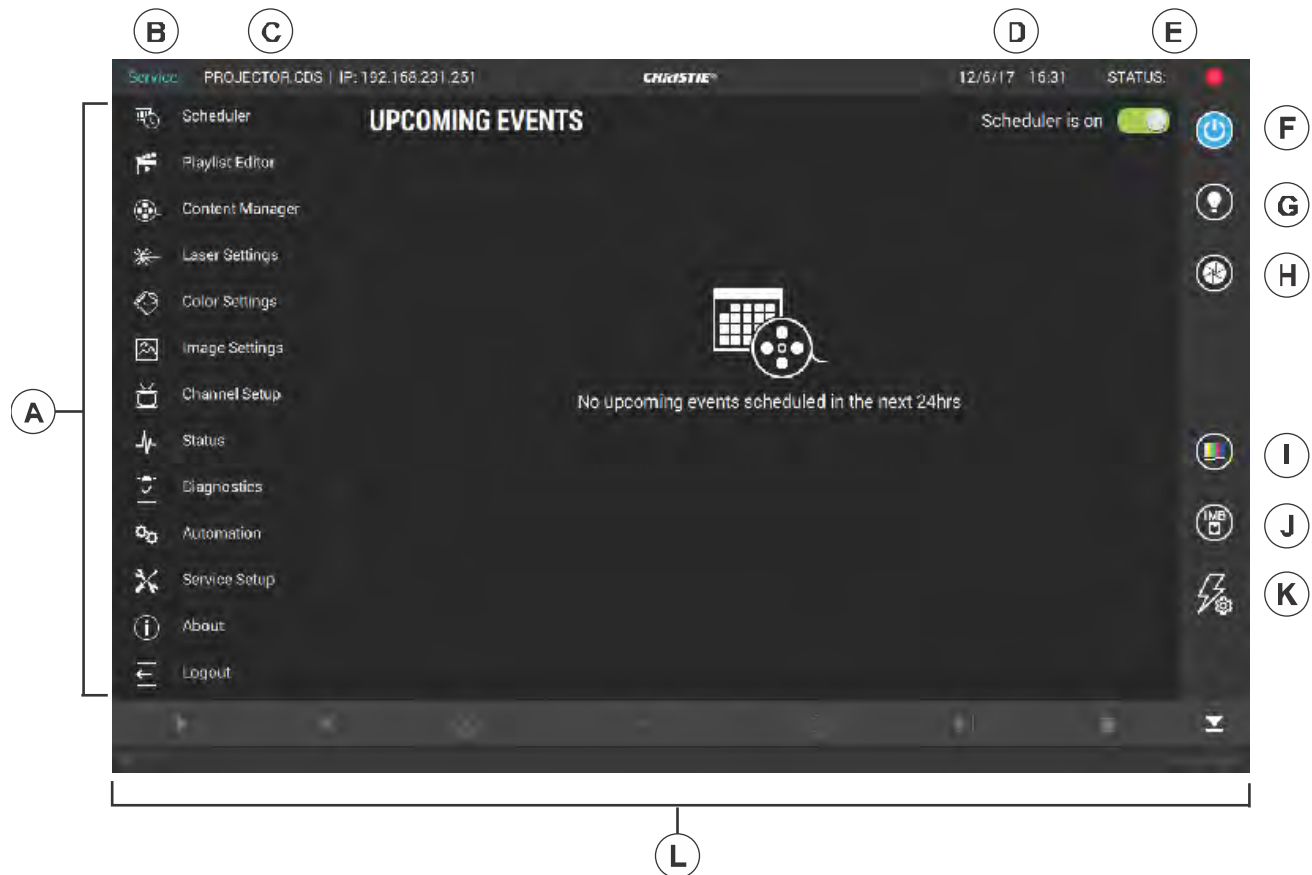

A	Left navigation menu. Your access permissions determine the available options.	G	Turns the light on or off.
B	Current access permissions.	H	Opens and closes the shutter.
C	Projector name and IP address.	I	Turns test patterns on or off.
D	Current date and time.	J	Displays channels.
E	System status. To display all alarms, select the colored icon.	K	Displays macros.
F	Turns the projector on or off.	L	Playback controls. See <i>Loading and playing content</i> (on page 40).

Using the Remote UI

Use the remote UI to access projector functionality.

1. Log into the Remote UI.

2. From the Remote UI default page, access the main projector user interface by clicking the **Projector Control** tab.
3. To upload and download files from the Projector, use the File Menu.
Examples of items that can be uploaded include:
 - Projector Upgrade packages
 - Backup packages to restore from
 - Rental files to license the projector for Rental mode
 - Test Patterns (PNG files only)
 - Gamma filesExamples of items that can be downloaded include:
 - Projector Backup files
 - Projector Certificates (required for content decryption)
 - Interrogator files (for support and troubleshooting)
4. If the projector has a GDC IMB SR-1000 installed and configured, you can access the GDC IMB Web UI by using the **Media Block** tab.

Technical support

Technical support for Christie Cinema products is available at:

- Support.cinema@christiedigital.com
- +1-877-334-4267
- Christie Professional Services: +1-800-550-3061 or NOC@christiedigital.com

Operating the projector

Learn how to operate the projector and adjust projector settings.

Projector power modes

The Cinema 4K-RGB projectors track laser operation hours for the laser optical sub-system (LOS). The projector operates with the following power modes:

Mode	Description
Projector on	<ul style="list-style-type: none"> • CineLife+ electronics and light engine are on • Laser optical sub-system (LOS) and thermo-electric cooler (TEC) devices are off • IMB is on
Light source on	<ul style="list-style-type: none"> • CineLife+ electronics and light engine are on • LOS and TEC devices are on • Fans run at full speed • IMB is on
Standby	<ul style="list-style-type: none"> • CineLife+ electronics remain on standby with the light engine off • Fans, LOS, and TEC devices are off • IMB is off (IMB automation does not function)

Turning the projector on or off

Turn on the projector to display content, or turn off the projector to conserve energy or service the projector.



To operate the projector, the circuit breakers must be in the ON position. If you are servicing the projector or removing the protective covers, ensure that the MAIN and UPS circuit breakers are in the off position.

In the right toolbar, select and hold **Power**. 

If the light source is on when turning off the projector, the light source enters a ten-minute cool-down period automatically.

Logging on to the projector

Log on to the projector to access projector menus.

1. Select **Login**.

2. In the User list, select a user name.
3. Enter your password.
4. Select **Login**.

Logging out of the projector

Log out of the projector to restrict access to projector menus or to change access permissions.

- Select **Logout**.

Turning the touch panel on or off

Turn the touch panel on to view projector menus, or turn the touch panel off to conserve energy.

- To turn the touch panel on or off, press the power button  (A) on the top of the touch panel.

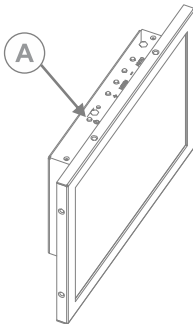

Calibrating the touch panel display

Calibrate the touch panel to improve its appearance and responsiveness to touch commands.

1. Log on to the projector.
2. In the left navigation menu, select **Service Setup > Preferences**.
3. Select **Touch Panel**.
4. To calibrate the touch panel, select **Start Calibration**.
5. Select and hold the center of each point as they appear.
The screen is dismissed after all points are calibrated.

Turning the light source on or off

Turn the light source on to display content or view test patterns, turn the light off to extend the life of the lasers.



- To turn the light source on or off, in the right toolbar, select and hold **Light**. 

If you turn on the light source when the projector power is off, power is turned on automatically.

Allow the projector to cool down for 10 minutes after turning it off.

Opening or closing the shutter

Open the shutter (douser) to display light on the screen, or close the shutter to remove light from the screen.

- In the right toolbar, select and hold **Shutter**. 
- If the shutter was closed, the shutter opens. 
- If the shutter was open, the shutter closes. 

The shutter sensor prevents light source activation when the shutter is closed.



In a situation where the shutter is not functioning, you can use the option for **Permit light source activation when shutter is nonfunctional** to permit activation of the light source. To enable this option, select **Service Setup > Preferences > Lens/ILS** and enable **Permit light source activation when shutter is nonfunctional**.

To avoid damage to the projector, only enable this option when the shutter can be verified as open.

Selecting the active channel

Select a channel to use customized projector settings for different inputs.

1. In the right toolbar, select **Channels**. 

The Channels window displays the available channels.
2. Select a channel.

In the Channel Setup panel, a green checkmark  indicates the active channel.

Adding a network time protocol server

Add a network time protocol (NTP) server to synchronize the time on all installed projectors in the same region.

1. In the left navigation menu, select **Service Setup > Time Setup**.
2. Switch to the **NTP Server** tab.
3. Select the **Time Sync using NTP Server** slider.

The color of the slider changes to green to indicate it is active.
4. Select **+ New NTP Server**.
5. Select a local or a public NTP server:
 - To use a local NTP server, select **Local Server** and type the IP address in the IP Address field.
 - To use a public NTP server, select **Public Server** and complete the Country and Server fields.
6. To test the connection, select **Test**.
7. Select **Add**.

Deleting a network time protocol server

Remove a network time protocol (NTP) server if you do not need to synchronize the time on all installed projectors in the same region.

1. In the left navigation menu, select **Service Setup** > **Time Setup**.
2. Switch to the **NTP Server** tab.
3. If network time protocol (NTP) time synchronization is not active, select **Time Sync using NTP Server**.
The color of the slider changes to green to indicate it is active.
4. In the NTP Server Address list, select an NTP server.
5. Select **Delete**. 
6. At the confirmation dialog, select **Delete**.

Changing the time zone

Change the time zone settings to make the projector time match the local time zone.

1. In the left navigation menu, select **Service Setup** > **Time Setup**.
2. Select the **Time Zone** tab.
3. In the Region list, select a region.
4. In the Time Zone list, select the time zone.
5. Select **Save**.

Changing the time format

You can use the 12-hour or 24-hour format to display projector time. The 24-hour format reduces ambiguity.

1. In the left navigation menu, select **Service Setup** > **Preferences**.
2. Select **General**.
3. In the System area, select a time format option:
 - To use the 12-hour format, select **12 Hours**.
 - To use the 24-hour format, select **24 Hours**.

Automatically adjusting the time for Daylight Saving Time

With automatically adjusted time settings, there is no need to update the projector time when Daylight Saving Time occurs.

1. In the left navigation menu, select **Service Setup** > **Time Setup**.
2. Select the **Time Zone** tab.

3. To automatically adjust the projector time to follow Daylight Saving Time, select **Automatically adjust for Daylight Saving Time**.
The color of the slider changes to green to indicate it is active.
4. Select **Save**.

Manually adjusting the time offset

You cannot manually adjust the time offset if network time protocol (NTP) time synchronization is active.



To turn off NTP time synchronization, select **Service Setup > Time Setup**, select the **NTP Servers** tab, and then select the **Time Sync via NTP Server** slider. The color of the slider changes to gray to indicate it is inactive.

1. In the left navigation menu, select **Service Setup > Time Setup**.
2. Select the **SM Time Adjust** tab.
3. Increase or decrease the time offset:
 - To increase the offset in minutes and seconds, select **Up**. ^
 - To decrease the offset in minutes and seconds, select **Down**. v

The Digital Cinema Initiatives (DCI) specification does not allow time offsets greater than six minutes in a calendar year.

4. Select **Save**.

Changing the orientation of the projected image

Change the orientation of the projected image from normal to inverted to support multi-projector installations where deflection mirrors are used.

1. In the left navigation menu, select **Service Setup > Preferences**.
2. Select **General**.
3. From the Projected Image Orientation list, select the required orientation for the projected image.

Orientation	Description
Normal Front	Projection from behind the audience with the projector in the normal, upright position.
Inverted Front	Projection from behind the audience with the projector in an inverted position (upside down).  Inverted positioning is not supported for Cinema 4K-RGB projectors. For more information, see the <i>Cinema 4K-RGB Installation and Setup Guide</i> (P/N: 020-102710-XX).
Normal Rear	Projection from behind the screen with the projector in the normal, upright position.
Inverted Rear	Projection from behind the screen with the projector in an inverted position (upside down).

Orientation	Description
	 Inverted positioning is not supported for Cinema 4K-RGB projectors. For more information, see the <i>Cinema 4K-RGB Installation and Setup Guide</i> (P/N: 020-102710-XX).

Changing the projector host name

Change the projector host name to make it easier to identify.

1. In the left navigation menu, select **Service Setup** > **Preferences**.
2. Select **General**.
3. In the Projector Hostname field, type a name.
4. Select **Update**.

Changing the temperature display

Set the touch panel to display temperatures in Celsius or Fahrenheit degrees.

1. In the left navigation menu, select **Service Setup** > **Preferences**.
2. Select **General**.
3. In the Temperature Units list, select **Celsius** or **Fahrenheit**.

Managing the light source

Learn how to configure a laser file and use the projector's LiteLOC™ feature.

The laser file allows you to control the power settings of the red, green, and blue (RGB) lasers. The LiteLOC™ feature ensures that color and brightness are held at the level you set.

You can create multiple laser files to manage varying screen sizes, brightness requirements, room temperatures in the projection booth, and types of content (such as 2D, 3D, and alternative content).

Creating a new laser file

Create a laser file to store the power settings for the RGB laser light source and the maximum expected room temperature for the projection booth.

The maximum (MAX) power limit for Red and Green changes according to the value set for the maximum expected room temperature. For Red, Green, and Blue power levels, system stability may be affected if levels are set below the minimum (MIN) power limit shown.

To ensure color and brightness are held at the required levels for your installation, Christie recommends that you enable LiteLOC™ for each laser file you create.

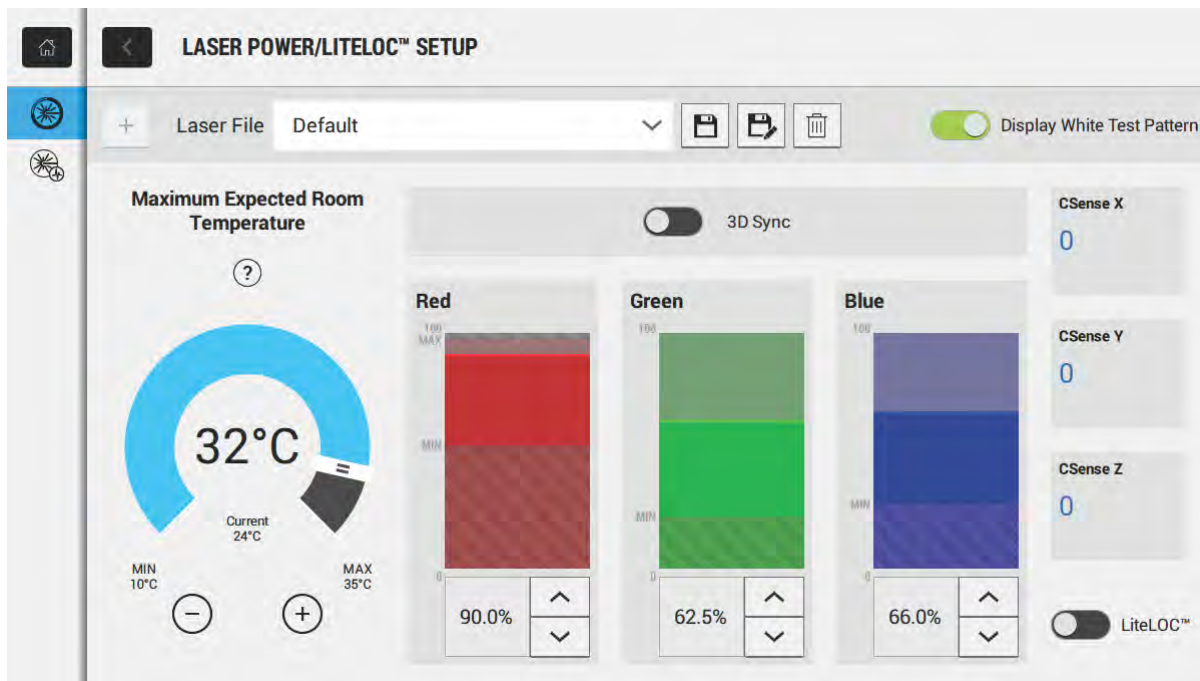

When refining the laser power settings, the amount of time required to re-stabilize the projector depends on the size of the adjustment. For very small adjustments to the expected room temperature

or power settings, the projector requires only 1 or 2 minutes to re-stabilize. For larger adjustments, the projector may require up to 15 minutes to re-stabilize.

1. In the left navigation pane, select **Laser Settings > Laser Power/LiteLOC Setup**.
2. To activate the controls, select the **Display White Test Pattern** slider.
3. To create a new laser file, select **Create**. 
4. In the Create dialog, type a name for the new laser file and select **Create**.
5. If the laser file will be associated with a 3D channel, select the **3D Sync** slider.
6. Under Maximum Expected Room Temperature, select the plus and minus signs (or drag the temperature slider) to indicate the maximum expected room temperature in the projection booth.

The system uses the maximum expected room temperature to calculate the light output. The default maximum expected room temperature setting is 25° C. A lower room temperature generally results in increased brightness and better efficiency. A higher room temperature will reduce the maximum power setting available for the lasers. The maximum expected room temperature setting must reflect actual operating conditions.



If you set a maximum expected room temperature that is below the existing ambient room temperature, the system displays a warning.

7. Set the approximate Red, Green, and Blue power levels as required for your projection environment and allow the projector to stabilize for 15 minutes.
System stability may be affected if you set a power level below the minimum power level recommended.
When setting the Red or Green power level, Christie recommends setting a level below the maximum (MAX) limit shown. A value below the maximum limit ensures an optimal brightness that can be maintained over time.
8. If color or brightness is not at the target level, refine the Red, Green, and Blue power settings to achieve the target, and then allow the projector to re-stabilize for an additional 3 to 5 minutes.



The projector is considered stable when there are no further adjustments and you obtain the same screen state results after two sets of measurements, 5 minutes apart.

9. Once the correct color and brightness are achieved and the projector has stabilized, select the **LiteLOC** slider to lock the settings.
The color of the slider turns to green to indicate the settings are locked. The projector's LiteLOC™ system maintains the brightness and color levels.
 10. To save the new laser file, select **Save**. 
- Color sensor (CSense) data are displayed on the interface to provide feedback on the current color sensor information.

Related information

Viewing laser diagnostic information (on page 97)

Modifying an existing laser file

Modify the settings in the laser file to change the laser power settings or the maximum expected room temperature.

When refining the laser power settings, the amount of time required to re-stabilize the projector depends on the size of the adjustment. For very small adjustments to the expected room temperature or power settings, the projector requires only 1 or 2 minutes to re-stabilize. For larger adjustments, the projector may require up to 15 minutes to re-stabilize.

1. In the left navigation pane, select **Laser Settings > Laser Power/LiteLOC Setup**.
2. To begin modifying the settings, select **Display White Test Pattern**.
3. From the Laser File list, select the laser file to edit.
4. To unlock the file, select the **LiteLOC** slider.
The color of the slider turns to gray to indicate the settings are unlocked.
5. Adjust the Maximum Expected Room Temperature and the power levels for Red, Green, and Blue as required to achieve the correct color and brightness on screen.
6. Once the correct color and brightness are achieved and the projector has stabilized, select the **LiteLOC** slider to lock the settings.
The color of the slider turns to green to indicate the settings are locked.
7. To save the new settings, select **Save**. 

Copying existing laser settings to a new file

Copy an existing laser file when you want to create a new file with similar settings.

1. In the left navigation pane, select **Laser Settings > Laser Power/LiteLOC Setup**.
2. Select the **Display White Test Pattern** slider.
3. From the Laser File list, select the file you want to copy.
4. To save the new laser file, select **Save As**. 
5. Type a new name for the laser file and then select **Save**.
6. Adjust the maximum expected temperature and power settings as required for the new configuration.

Deleting a laser file

Delete a laser file when the configuration is no longer required.

1. In the left navigation menu, select **Laser Settings > Laser Power/LiteLOC Setup**.
2. Select the **Display White Test Pattern** slider.
3. In the Laser File list, select the file to delete.
4. Select **Delete**. 
5. To confirm the deletion, select **Delete**.

Managing user accounts

Learn how to create new user accounts, how to modify the properties of those accounts, and how to remove the accounts. A user account is a set of credentials consisting of both a user name and password that allows access to projector settings.

Default user access permissions

This table lists the Christie touch panel access permissions.

Permission	Description
installer	Can define Ethernet settings (IP network address), restore backup files, and upgrade the system software.
manager	Can activate channels and test patterns, view detailed diagnostic logs for in-depth troubleshooting and view server errors. This is the default level.
marriage	Can access all touch panel windows. Can authorize projector marriage.
operator	Can view basic projector status, diagnostic information and software version information. This is the default level for Serial Communication sessions.
service	Can access all touch panel windows. Cannot authorize projector marriage.

Adding a user account

Adding a user account allows users to access projector menus.

1. In the left navigation menu, select **Service Setup > User Accounts**.
2. Select **+ Add User**.
3. Complete the Name, Permissions, New Password, and Confirm Password fields.
4. Select **Add**.

Changing user account permissions

Change user account permissions to limit or increase access to projector menus and functionality.

1. In the left navigation menu, select **Service Setup > User Accounts**.
2. In the left pane, select a user account.
3. In the Permissions list, select a new permissions setting.
4. Select **Save**.

Changing a user account password

Periodically change a user account password to limit access to projector menus and functionality to authorized users.

1. In the left navigation menu, select **Service Setup > User Accounts**.
2. In the left pane, select a user account.
3. Select **Change password**.
4. Complete the New Password and Confirm Password fields.
5. Select **Save**.

Deleting a user account

Delete a user account to prevent access to projector menus and functionality.

1. In the left navigation menu, select **Service Setup > User Accounts**.
2. In the left pane, select a user account.
3. Select **Delete**. 
4. To confirm the deletion, select **Delete**.

Network settings

Learn how to connect the projector to media devices and wired networks.



The system provides the MAC address of the projector automatically.

Connecting the projector to the theater network

Connect the projector to the theater network to control it remotely and allow it to communicate with other network devices.

1. Connect the Ethernet cable from the theater network to the **Management** port on the input panel.
2. In the left navigation menu, select **Service Setup > Network Settings**.
3. In the Port list, select **Management**.
4. Enter the network settings:
 - To obtain the network settings automatically, select **Automatic**.
 - To enter the settings manually, select **Manual** and complete these fields:

Field	Description
IP Address	The IP address of the projector.
Subnet Mask	The subnet mask to which the IP address belongs.
Gateway	The IP address for the network gateway.
Primary DNS	The IP address of the primary DNS server.
Secondary DNS	The IP address of the secondary DNS server.

5. Select **Save**.

Connecting the projector to network attached storage

To ingest and play content, a network attached storage (NAS) device must be connected to the projector.

1. Connect the NAS device to the NAS port on the input panel.
2. In the left navigation menu, select **Service Setup > Network Settings**.
3. In the Port list, select **Content-NAS**.
4. Enter the network settings:
 - To obtain the network settings automatically, select **Automatic**.

- To enter the settings manually, select **Manual** and complete the IP Address and Subnet Mask fields.
5. Select **Save**.

Connecting the projector to a media or content network

Connect the projector to a media or content network to play content.

1. Using an Ethernet cable, connect the Library Media Server (LMS) network or the network-attached storage (NAS) device to the Media port on the projector.
2. In the left navigation menu, select **Service Setup > Network Settings**.
3. In the Port list, select **Media**.
4. Enter the network settings:
 - To obtain the network settings automatically, select **Automatic**.
 - To enter the settings manually, select **Manual** and complete the IP Address and Subnet Mask fields.
5. Select **Save**.

Activating SNMP

Activate the Simple Network Management Protocol (SNMP) to monitor the theater network for conditions that indicate communication or hardware failures.

On Cinema 4K-RGB projectors, SNMP is enabled by default.

1. In the left navigation menu, select **Service Setup > Network Settings**.
2. Select the **SNMP** tab.
3. Select the **SNMP** slider.
The color of the slider changes to green to indicate it is active.
4. In the SNMP Settings area, select the SNMP version.
5. Complete the Trap Receiver IP fields.
A trap receiver captures, displays, and logs SNMP traps. Traps are event notices that are sent immediately to the trap receiver from a network device. The SNMP device does not need to use resources to poll for these event notices.
6. In the Blocked SNMP Traps area, select the SNMP traps you want to block.
7. Select **Save**.

Downloading MIB information

A Management Information Base (MIB) file contains the definitions for the device being managed by the SNMP protocol.

1. In the left navigation menu, select **Service Setup > Network Settings**.

2. Select the **SNMP** tab.
3. Select **Download MIB**.
4. Browse to the location where you want to save the MIB file.
5. In the Name field, type a name for the MIB file.
6. Select **Accept**.
7. Select **OK**.

Setting up an integrated media block

You can configure Cinema 4K-RGB projectors to work with different models of integrated media blocks (IMB).

Selecting IMB preferences

Choose from the available options to set the type of integrated media block (IMB).

1. To set the type of IMB, select **Service Setup** > **Preferences**.
2. Select **IMB**.
3. In the Type list, select from the available IMB models.
4. When the system prompts you to reboot the projector, select **Reboot**.
5. After the projector has restarted, log in with your user account.

Activating IMB marriage

After selecting the IMB type, you must install the IMB and complete marriage to display secure content. You cannot complete marriage remotely.

The marriage wizard requires you to confirm that the IMB has not been tampered with.

1. Install the IMB in the available slot on the projector.
For more information, see the *Christie IMB-S3 Installation and Setup Manual (P/N: 020-102582-XX)* or the documentation provided by the IMB manufacturer.
2. In the left navigation menu, select **Service Setup** > **Marriage Setup**.
3. Select **Start** and confirm that the security manager (SM), service door, and marriage ring are secure.
4. Select **Next** and complete the marriage checklist, confirming that the following are secure:
 - All fan clips are tightened on the four fan pack at the front of the light engine compartment.
 - Fan pack spring pins are locked in place to prevent removal of the light engine fan pack.
 - Projector front cover is installed.
5. Select **Next** and enter the Marriage user and password credentials.
6. Select **Login**.
7. To start the marriage process, press the Marriage button on the projector within 30 seconds. The system starts the marriage process and indicates when the process is completed successfully.







8. Select **Finish**.

Managing content

Use the procedures in this section to manage content and keys.

Content manager icons

These icons appear in the content manager.

Icon	Description
	The content is presented in flat format.
	The content is presented in scope format.
2D	2D content identifier.
	3D content identifier.
	A subtitle file is included with the content.
	A closed captioning file is included with the content.
2K	2K content identifier.
4K	4K content identifier.
ATMOS	The content includes a Dolby Atmos audio file.
	High frame rate identifier.
	Extended Dynamic Range (EDR) content.

Ingesting content and keys

To ingest content, an ingest device must be connected to the projector. The ingest device must be properly configured and operating correctly.

If an ingest device is not connected to the projector, the Content Manager menu is not displayed.

1. In the left navigation menu, select **Content Manager**.
2. Select the **Ingestible Content** tab.
3. In the Source list, select a source for the content.
Ingest devices connected to the projector are automatically added to the Source list.
4. In the Show list, select the content type.
5. Select the checkbox to the left of the content you want to ingest, or select the empty check box at the top of the column to select all content.

6. Select **Ingest**.
7. To view the ingest progress, select the **Progress** tab.

Canceling an ingest

Cancel an ingest if the operation is taking too long, or if the content has been ingested previously.

1. Through the Content Manager, run an operation to ingest content and keys. See *Ingesting content and keys* (on page 37).
2. Switch to the **Progress** tab.
3. Select the checkbox to the left of the content.
4. Select **Cancel**.

Viewing remaining NAS storage capacity

View the remaining NAS storage capacity to determine if additional storage is required.

1. In the left navigation menu, select **Content Manager**.
2. Review the remaining storage capacity displayed on the **Local Content** select.

Filtering content by type

Filter content by type to locate content of a specific type or reduce the return results.

1. In the left navigation menu, tap **Content Manager**.
2. On the **Local Content** tab in the Show list, select the content type.

Viewing available keys

Keys are required to play encrypted content.

1. In the left navigation menu, select **Content Manager**.
2. To view the available keys, switch to the **Keys** tab.

Filtering the key list

Filter the key list to locate keys of a specific type.

1. In the left navigation menu, select **Content Manager**.
2. Select the **Keys** tab.
3. In the Show list, select one of the following options for filtering the list:
 - All Keys
 - Not Yet Valid
 - Valid

- Expiring Soon
- Expired

In the column heading, select **Resize**. 

Deleting local content

Delete local content to increase local storage space.

1. In the left navigation menu, select **Content Manager**.
2. On the **Local Content** tab, select the check box to the left of the content, or select the empty check box at the top of the column to select all content.
3. Select **Delete**.
4. To confirm the deletion, select **Delete**.

Deleting keys

Delete keys when they are no longer required.



Key Delivery Message (KDM) keys are automatically deleted when they expire.

1. In the left navigation menu, select **Content Manager**.
2. Select the **Keys** tab.
3. Select the check box to the left of the keys.
4. Select **Delete**.
5. To confirm the deletion, select **Delete**.

Collapsing or expanding columns

Expand or collapse columns to display more or less information.

- In the column heading, tap **Resize**. 



Viewing content details

The Properties panel provides detailed information about the selected content.

1. In the left navigation menu, select **Content Manager**.
2. Switch to the **Local Content** tab.
3. Select **Details** .

Loading and playing content

To play content it must be loaded first.

1. In the left navigation menu, select **Content Manager**.
2. Select and hold **Load**. 
3. Load local content or a playlist:
 - To load a playlist, select the **Playlists** tab.
 - To load locally stored content, select the **Local Content** tab.
4. Select to select the playlist or content.
5. Select **Load**. 
- The Loading Media dialog displays progress information.
6. To start playback, select and hold **Play**. 

Unloading content

Unload content when it has finished playing and is no longer required.

1. Stop or pause playback.
2. Select **Unload**. 

Managing playlists



Use the procedures in this section to manage playlists. A playlist is a list of content files and automated events that play in an order that you define.

Creating a new playlist

A playlist is a list of content files and automated events that play in an order that you define.



- To manage minor time gaps between content files, Christie recommends inserting a short period of black screen with no audio. To achieve this, you can insert a BLACK MOS clip into the playlist. BLACK MOS clips are small, silent compositions and are set in varying lengths to accommodate different projection requirements. The clips are available from content distributors.
- When working in a multi-projector environment, make sure each piece of content in a playlist is at least five seconds in length.

1. In the left navigation menu, select **Playlist Editor**.
2. In the right pane, select **New Playlist**. 
3. In the Create New Playlist dialog, type a name for the playlist and select **Create**.
4. Add content or an automation event to the playlist:
 - To add content to the playlist, select the content item shown under the **Local Content** tab.
 - To add an automation event or macro to the playlist, select a content item in the playlist and then switch to the **Automation** tab. Select the automation event or macro item to add it to the playlist.
5. In the right pane, select **Save**. 

Reordering playlist content

Reorder the playlist content to change the time when content plays.

1. In the left navigation menu, tap **Playlist Editor**.
2. In the upper right pane, select a playlist from the list.
3. Tap the content or a macro in the playlist.
4. To select a new position for the content or macro, tap the down arrow and select the number for the new position. For example, selecting **1** moves the item to the top of the playlist.
5. Tap **Save**. 



Adding a time offset to a macro

An offset identifies when a macro plays in a playlist.

1. In the left navigation menu, select **Playlist Editor**.
2. In the upper right pane, select a playlist.
3. Tap a macro in the playlist and then select **Edit**. 
4. In Edit Automation dialog, select one of these options from the Offset Type list:
 - a) To run a macro at a time you define that is offset from the start of the macro you selected in step 3, select **After Clip Start**.
 - b) To run a macro at a time you define that is offset from the end of the content you selected in step 3, select **Before Clip End**.
 - c) To pause playback, select **Before Clip Start**. Playback does not resume until the system runs all of the input cues or macros with a time offset value of Before Clip Start. If **Before Clip Start** is not selected, playback is not paused.
If the content contains an FFMC (First Frame Moving Credits) marker, you can also choose the **FFMC** option to set actions associated with the final credits roll.
5. Under Offset Time, adjust the time the automation occurs.
6. Select **Update**.

Replacing playlist content

Replace playlist content when content has been added in error, or you want to add new content to an existing playlist.

1. In the left navigation menu, tap **Playlist Editor**.
2. In the upper right pane, select a playlist from the list.
3. Tap the content in the playlist.
4. Tap **Replace Content**. 
5. In the Replace Content dialog, select the new content.
6. Tap **Replace**.
7. Tap **Save**. 

Removing playlist content



Remove playlist content when content has been added in error, or you want to update an existing playlist.

1. In the left navigation menu, tap **Playlist Editor**.
2. In the playlist list in the upper right pane, select the playlist you want to update.
3. Tap content in the playlist.
4. Tap **Remove Content**. 

5. Tap **Save**. 

Copying a playlist

Copy a playlist when you want to quickly create a playlist with similar content.

1. In the left navigation menu, select **Playlist Editor**.
2. In the playlist list in the upper right pane, select the playlist you want to copy.
3. Select the menu  and then select **Save As**. 
4. In the Save Playlist dialog, type a new name for the playlist.
5. Select **Save**. 

Opening an intermission playlist

Open an intermission playlist from the top level playlist.

1. In the left navigation menu, tap **Playlist Editor**.
2. Select the playlist with the intermission item to open.
3. In the right pane, tap the intermission item and then tap **Open Intermission Playlist**. 

The intermission playlist items are displayed in the right pane.

Viewing details about playlist content

The Details dialog provides detailed information about the selected content.

1. In the left navigation menu, tap **Playlist Editor**.
2. Under the Local Content tab, to the right of the content, tap **Details**. 

Importing a playlist

Import a playlist from another projector or computer on the network.

1. In the left navigation menu, tap **Playlist Editor**.
2. In the right pane, tap the menu  and then tap **Import Playlists**.
3. In the Import dialog, navigate to the playlist you want to import and select it.
A filter of *.ply is applied automatically to display available playlist files.
4. Tap **Accept**.

Exporting a playlist

Export an existing playlist to another projector or computer on the network.

1. In the left navigation menu, tap **Playlist Editor**.
2. In the right pane, select the playlist you want to export.
3. Tap the menu  and then tap **Export Playlists**.
4. In the Export dialog, navigate to the location you want to export to.
5. Tap **Export**.

Deleting a playlist

Delete a playlist when it is no longer required or when the content has expired.

1. In the left navigation menu, tap **Playlist Editor**.
2. In the playlist list in the upper right pane, select the playlist you want to delete.
3. Tap the menu  and then tap **Delete**.
4. To confirm the deletion, tap **Delete**.

Working with channels

Create channels to store customized projector settings for different inputs.

Adding a channel for HDMI input

Create a channel to store customized projector settings for input devices connected to the HDMI port.

1. In the left navigation menu, select **Channel Setup**.
2. Select **+ Add Channel**.
3. Complete these fields:

Field Name	Description
Name	The channel name.
Input Type	Select one of: <ul style="list-style-type: none"> • HDMI Input 1 • HDMI Input 2 • HDMI 3D LR • Addon Card • IMB
Data Format	The source color depth (8-10-12 bit) for the channel. If the HDMI source is 2K or greater, select one of: <ul style="list-style-type: none"> • 4K 4:4:4 (RGB) 8 bits • 4K 4:2:2 (YCbCr) 12 bits • 4K 4:2:2 (YCbCr) 10 bits • 4K 4:2:2 (YCbCr) 8 bits
Scan Type	The video scan type. The default is Auto.
3D Sync Input Mode	Specifies whether a specific frame of input data has left eye or right eye data. The default is Auto.
Color Space	The method of color decoding for the current source. The default is Unity RGB for all HDMI sources.
ILS File	The ILS file associated with the channel.
2D Laser File	The 2D laser file associated with the channel. Any changes made to the laser file settings are applied to all channels that use this laser file.
3D Laser File	The 3D laser file associated with the channel. Any changes made to the laser file settings are applied to all channels that use this laser file.
2D MCGD File	The Measured Color Gamut Data file associated with the 2D image.

Field Name	Description
3D MCGD Left Eye File	The Measured Color Gamut Data file associated with the left 3D image.
3D MCGD Right Eye File	The Measured Color Gamut Data file associated with the right 3D image.
TCGD File	The Target Color Gamut Data file associated with the channel.
Screen File	The screen type, masking, cropping, and lens settings for the channel.
Gamma File	The gamma correction required for the proper tonal range of the source material.
Clut File	Applies a 3D color cube for increased color accuracy.
3D File	The 3D settings files associated with the channel.
Source File	The resolution and aspect ratio for the channel.
HDMI EDID	The HDMI standard associated with associated with the channel.
Christie Pureformity Color™ Correction File	The color correction file associated with the channel. The default value is Bypass.
Warp File	The warp file associated with the channel. The default value is Bypass.

4. Select **Save**.

Adding a channel for IMB input

Create a channel to store customized projector settings for input devices connected to the IMB.

1. In the left navigation menu, select **Channel Setup**.
2. Select **+ Add Channel**.
3. Complete these fields:

Field Name	Description
Name	The channel name.
Input Type	Select IMB.
3D Sync Input Mode	<p>For third party IMBs, specifies how 3D input data is encoded. The default setting is 2D.</p> <ul style="list-style-type: none"> • 2D Mode: No 3D synchronization is applied. • 3D Frame Interleaved: For input that contains left eye data followed by right eye data. • 3D Frame Interleaved Inverted: For input that contains right eye data followed by left eye data. • 3D White Line/Blue Line: For input that includes metadata describing the 3D encoding. • 3D White Line/Blue Line Inverted: For inverted input that includes metadata describing the 3D encoding. • 3D Line Interleaved: The left eye and right eye data are sent on alternating lines. <p>3D Sync Input Mode is not required when using the Christie IMB.</p>

Field Name	Description
	For GDC IMB devices, the recommended setting is 3D Line Interleaved.
ILS File	The ILS file associated with the channel.
2D Laser File	The 2D laser file associated with the channel. Any changes made to the laser file settings are applied to all channels that use this laser file.
3D Laser File	The 3D laser file associated with the channel. Any changes made to the laser file settings are applied to all channels that use this laser file.
2D MCGD File	The Measured Color Gamut Data file associated with the 2D image.
3D MCGD Left Eye File	The Measured Color Gamut Data file associated with the left 3D image.
3D MCGD Right Eye File	The Measured Color Gamut Data file associated with the right 3D image.
TCGD File	The Target Color Gamut Data file associated with the channel.
Screen File	The screen type, masking, cropping, and lens settings for the channel.
Gamma File	The gamma correction required for the proper tonal range of the source material.
Clut File	Applies a 3D color cube for increased color accuracy.
3D File	The 3D settings file associated with the channel.
Source File	The resolution and aspect ratio for the channel.
Christie Pureformity Color™ Correction File	The color correction file associated with the channel. The default value is Bypass.
Warp File	The warp file associated with the channel. The default value is Bypass.

4. Select **Save**.

Editing an existing channel

Edit an existing channel when the parameters of the input device change.

1. In the left navigation menu, select **Channel Setup**.
2. In the left pane, select a channel.
3. Edit the channel settings.
4. Select **Save**.

Copying existing channel settings to a new channel

Copy a channel to create a new channel with similar settings.

1. In the left navigation menu, select **Channel Setup**.
2. In the left pane, select a channel.
3. Select **Save As**.

4. Type a name for the new channel and select **Save**.

Viewing the channel list

The channel list displays all of the available channels.



- In the left navigation menu, select **Channel Setup**.
Under Channel Setup, the available channels are displayed in the left pane. A green checkmark  indicates the active channel.

Alternatively in the right toolbar, select **Channels**. 

The All Channels window displays the available channels and the active channel is highlighted.

Moving a channel up or down the channel list

If a channel is selected frequently, move it to the top of channel list to make it easier to access. If the channel is not selected frequently, move it to the bottom of the channel list.

1. In the left navigation menu, select **Channel Setup**.
2. In the left pane, select a channel.
3. To move the channel up or down the list, select  or .

Deleting a channel

Delete a channel when the settings for the input device are no longer required.



1. In the left navigation menu, select **Channel Setup**.
2. In the left pane, select a channel.
3. Select **Delete**. 
4. To confirm the deletion, select **Delete**.

Managing color setting files

Use the procedures in this section to manage color setting files. When associated with a channel, a color setting file defines the color output for the content.

Creating a MCGD file

Create Measured Color Gamut Data (MCGD) files to correct on-screen colors. A colorimeter is required to complete this procedure.

1. Activate the channel that uses the laser file the MCGD file is being created for.
2. Turn on the light source and allow it to operate for 20 minutes.
3. In the left navigation menu, select **Color Settings > MCGD File Setup**.
4. Select **Create MCGD File**. 
5. Type a name for the MCGD file and select **Create**.
6. If the MCGD file will be associated with a 3D channel, select the **3D Sync** slider.
7. In the red area of the chromaticity image, select the empty circle.
The test pattern is automatically displayed.
8. Measure the red chromaticity with the colorimeter.
9. Type the red chromaticity value in the **X** field.
10. Select **Next** and type the red chromaticity value in the **Y** field.
11. Repeat steps 8 to 10 for the green, blue, white (center circle), and black chromaticity measurements.
12. Select **Save**. 

Editing an existing MCGD file

Edit an existing Measured Color Gamut Data (MCGD) file when on-screen color readings change.

1. In the left navigation menu, select **Color Settings > MCGD File Setup**.
2. In the MCGD File list, select a MCGD file.
3. Edit the measured color values.
4. Select **Save**. 

Copying existing MCGD file settings to a new file

Copy an existing Measured Color Gamut Data (MCGD) file when you want to create a new MCGD file with similar settings.

1. In the left navigation menu, select **Color Settings > MCGD File Setup**.
2. In the MCGD File list, select a MCGD file.
3. Select **Save As.** 
4. Type a name for the MCGD file and select **Save**.



Deleting a MCGD file

Delete a Measured Color Gamut Data (MCGD) file when it is no longer required.

1. In the left navigation menu, select **Color Settings > MCGD File Setup**.
2. In the **MCGD File** list, select a MCGD file.
3. Select **Delete.** 
4. To confirm the deletion, select **Delete**.

Creating a TCGD file

Typically, Target Color Gamut Data (TCGD) file settings are defined by the content provider and are not modified. A colorimeter is required to complete this procedure.

1. Turn on the light source and allow it to operate for 20 minutes.
2. In the left navigation menu, select **Color Settings > TCGD File Setup**.
3. Select the **Create TCGD File.** 
4. Type a name for the TCGD file and select **Create**.
5. To display test clips automatically when you select a color in the chromaticity image, select **Automatically Display Test Clip**.
6. To modify the white clipping values and improve image detail in very bright areas of the image, select **Use White Clip**.
7. select the option button in the red area of the chromaticity image to display the red test pattern.
8. Measure the red chromaticity with the colorimeter.
9. Type the red chromaticity values in the **Red X** and **Red Y** fields.
10. Adjust the **Gain** value to modify the color brightness.
11. Repeat steps 8 to 10 for the magenta, blue, cyan, white, yellow, and green chromaticity measurements.
12. To adjust the color of the white light in a specific area of the screen, select **White Tolerance** and a screen area.
13. Select **Save.** 

Editing an existing TCGD file

Edit an existing Target Color Gamut Data (TCGD) file when color readings change.

1. In the left navigation menu, select **Color Settings > TCGD File Setup**.
2. In the **TCGD File** list, select a TCGD file.
3. Edit the TCGD file settings.
4. Select **Save**. 

Copying existing TCGD file settings to a new file

Copy an existing Target Color Gamut Data (TCGD) file when you want to create a new TCGD file with similar settings.

1. In the left navigation menu, select **Color Settings > TCGD File Setup**.
2. In the TCGD File list, select a TCGD file.
3. Select **Save As**. 
4. Type a name for the TCGD file and select **Save**.

Deleting a TCGD file

Delete a Target Color Gamut Data (TCGD) file when it is no longer required.

1. In the left navigation menu, select **Color Settings > TCGD File Setup**.
2. In the TCGD File list, select a TCGD file.
3. Select **Delete**. 
4. To confirm the deletion, select **Delete**.

Adjusting the image size and position

Learn how to enable and modify projector image settings.

Activating the Intelligent Lens System



Activate the Intelligent Lens System (ILS) to automatically adjust the position of the lens.

On Cinema 4K-RGB projectors, the ILS is enabled by default.

1. In the left navigation menu, select **Service Setup** > **Preferences**.
2. Select **Lens/ILS**.
3. In the right pane, select the **ILS Installed** slider.
The color of the slider changes to green to indicate the ILS is active.

Creating a new ILS file

Create an Intelligent Lens System (ILS) file to set the X, Y, zoom, and focus positions of the lens.

1. In the left navigation menu, select **Image Settings** > **ILS File Setup**.
2. Select **Create ILS File**. 
3. Type a name for the ILS file and select **Create**.
4. In the Lens position area, select the forward, backward, left, or right arrow icons to move the position of the image on the screen.
5. In the **Focus** area, select **Up** (^) or **Down** (v) to increase or decrease image focus.
6. In the **Zoom** area, select **Up** (^) or **Down** (v) to increase or decrease image zoom.
7. Select **Save**. 

Automatically calibrating the ILS

Use the Auto Calibrate feature of the Intelligent Lens System (ILS) to find and compensate for motor backlash, and to determine the movement range for the currently installed lens.

1. In the left navigation menu, select **Image Settings** > **ILS File Setup**.
2. Select **Auto Calibrate**.
3. In the confirmation dialog, select **Continue**.

Editing ILS file settings

Edit Intelligent Lens System (ILS) file settings when content requirements change.

1. In the left navigation menu, select **Image Settings > ILS File Setup**.
2. In the ILS File list, select an ILS file.
3. Modify the ILS file settings.
4. Select **Save**. 

Copying existing ILS file settings

To duplicate Intelligent Lens System (ILS) file settings quickly, copy the settings of an existing file to a new ILS file.

1. In the left navigation menu, select **Image Settings > ILS File Setup**.
2. In the ILS File list, select the ILS file you want to copy.
3. Select **Save As**. 
4. Type a name for the ILS file and select **Save**.

Deleting an ILS file

Delete an Intelligent Lens System (ILS) file when it is no longer required.

1. In the left navigation menu, select **Image Settings > ILS File Setup**.
2. In the ILS File list, select the ILS file you want to delete.
3. Select **Delete**. 
4. To confirm the deletion, select **Delete**.

Resetting the lens



Use the Reset Lens feature to have the Intelligent Lens System (ILS) find the home position flags that allow the ILS to compensate for drift over time, or move to its proper position after it has been manually adjusted.

1. In the left navigation menu, select **Image Settings > ILS File Setup**.
2. Select **Reset Lens**.
3. In the confirmation dialog, select **Continue**.

Creating a source file

Create source files to store resolution, offset, and aspect ratio settings for input devices. When the Auto Square Pixels file is selected, the incoming video format is automatically detected.

1. In the left navigation menu, select **Image Settings > Source File Setup**.

2. Select **Create Source File.** 
3. Type a name for the source file and select **Create.**
4. In the Source Media Resolution area, adjust the width and height of the source media.
5. Select an aspect ratio or type a custom aspect ratio for the source media.
6. In the Position area, adjust the horizontal and vertical position of the source media.
7. Select **Save** .

Editing source file settings

Edit source file settings when the settings of the input device change.

1. In the left navigation menu, select **Image Settings > Source File Setup.**
2. In the Source File list, select a source file.
3. Modify the source file settings.
4. Select **Save.** 

Copying existing source file settings to a new source file

To duplicate existing source file settings quickly, copy the settings of an existing file to a new source file.

1. In the left navigation menu, select **Image Settings > Source File Setup.**
2. In the Source File list, select the source file you want to copy.
3. Select **Save As.** 
4. Type a name for the source file and select **Save.**

Deleting a source file

Delete a source file when it is no longer required.

1. In the left navigation menu, select **Images Settings > Source File Setup.**
2. In the Source File list, select the source file you want to delete.
3. Select **Delete.** 
4. To confirm the deletion, select **Delete.**

Creating a screen file

Use screen files to define the size of the display panel and image cropping. You can assign the same screen file to multiple input devices.

1. In the left navigation menu, select **Image Settings > Screen File Setup**.
2. Select **Create Screen File**. 
3. Type a name for the screen file and select **Create**.
4. To crop the image in a specific location, select one of the screen icons.



5. To adjust the amount of cropping on the X or Y axis, move the slider up or down.
6. To display all image data and maintain the aspect ratio, select the **Letterbox** slider. The color of the slider changes to green to indicate it is active.
7. If required, adjust the **Anamorphic Lens Factor** value to match the lens installed.
8. Select **Save**. 

Editing screen file settings

Edit screen file settings when the image parameters change.

1. In the left navigation menu, select **Image Settings > Screen File Setup**.
2. In the Screen File list, select a screen file.
3. Modify the screen file settings.
4. Select **Save** .

Copying existing screen file settings to a new screen

To duplicate screen file settings quickly, copy the settings of an existing file to a new screen file.

1. Select **Image Settings** > **Screen File Setup**.
2. In the Screen File list, select the screen file you want to copy.
3. Select **Save As** .
4. Type a name for the source file and select **Save**.

Deleting a screen file

Delete a screen file when it is no longer required.

1. In the left navigation menu, select **Image Settings** > **Screen File Setup**.
2. In the Screen File list, select the screen file you want to delete.
3. Select **Delete**. .
4. To confirm the deletion, select **Delete**.

Performing digital convergence

Perform digital convergence to improve the quality of the on-screen image.

1. In the left navigation menu, select **Image Settings** > **Digital Convergence**.
2. Select the up, down, left, or right arrows to adjust the position of the red, green, or blue digital micromirrors (DMDs).

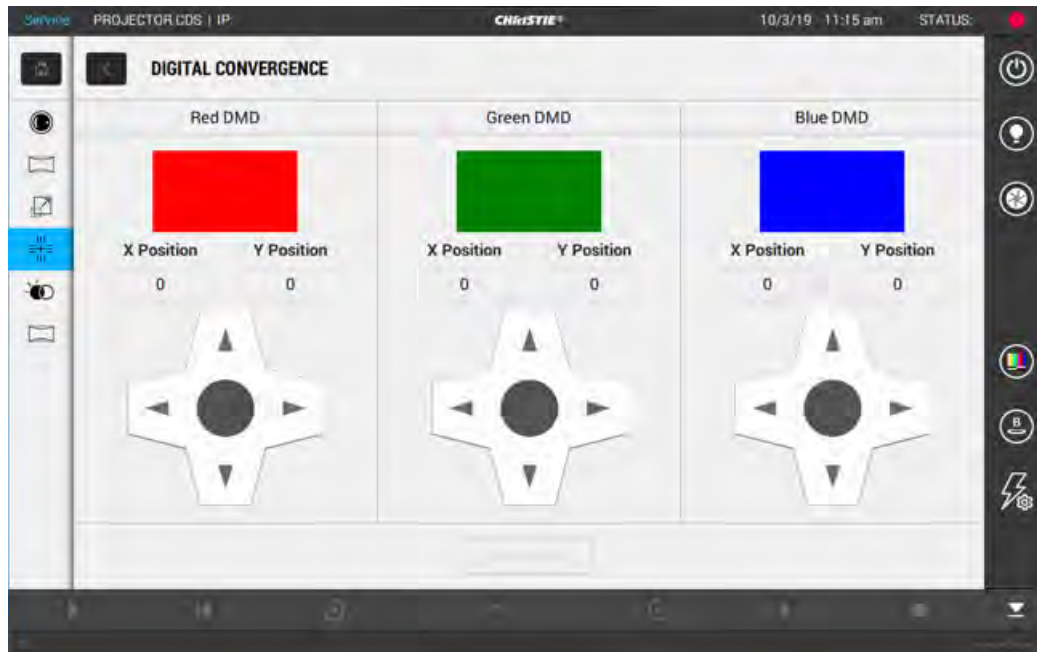

Resetting digital convergence to the default settings

Reset digital convergence to the default settings when image parameters change.

1. In the left navigation menu, select **Image Settings > Digital Convergence**.
2. Select **Reset Defaults**.

Adjusting the image

Adjust the projector image. Christie recommends warming the lens before completing these procedures as focus may change as the lens warms.

Correcting vignetting

An image that is brighter at the center than it is at the sides needs vignetting correction.

If your image suffers from vignetting, the lens has reached the end of its offset travel range.

If your installation does not allow the image to be centered with the center of the screen, move the entire projector in the direction of lens travel.

Correcting keystone effect

Learn how to adjust the image to correct keystone effect.

Keystone effect occurs when you project an image onto the screen at an angle. As a result, the image appears distorted and resembles a trapezoid.

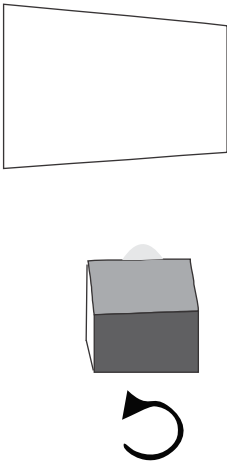
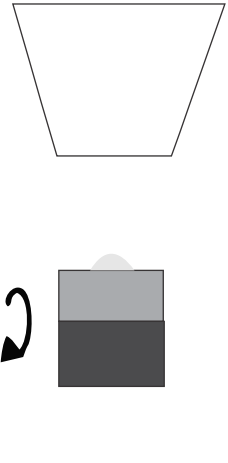

When making the adjustments, set the light source to minimum power.

Horizontal keystone	Vertical keystone
	
Projector skewed horizontally to the screen	Projector tilted vertically to the screen

1. If the image suffers from slight keystone effect, it can be corrected with electronic cropping.
2. If the keystone effect is severe, you can unevenly adjust the feet to compensate for projector tilt.

It is recommended that you use lens offset to align the center of the image to the center of the screen before you correct the keystone effect.

3. If one side of the image is longer than another, adjust the tilt and level of the projector.

Adjusting the integrator rod and fold mirror

Understand how to adjust the integrator rod and fold mirror to control the illumination spot on the DMD.

Extreme misalignment of projection optics can cause permanent damage to critical optical components. Only Christie qualified technicians can perform internal optical adjustments.

The integrator rod and fold mirror adjustments are set by Christie. Make adjustments only if screen shadows are visible.



When adjusting the fold mirror, set the light source to minimum power.

1. In the right toolbar, select **Test Patterns**. 
2. Select the **RGB-4K-Integrator Rod** test pattern and display it full screen.

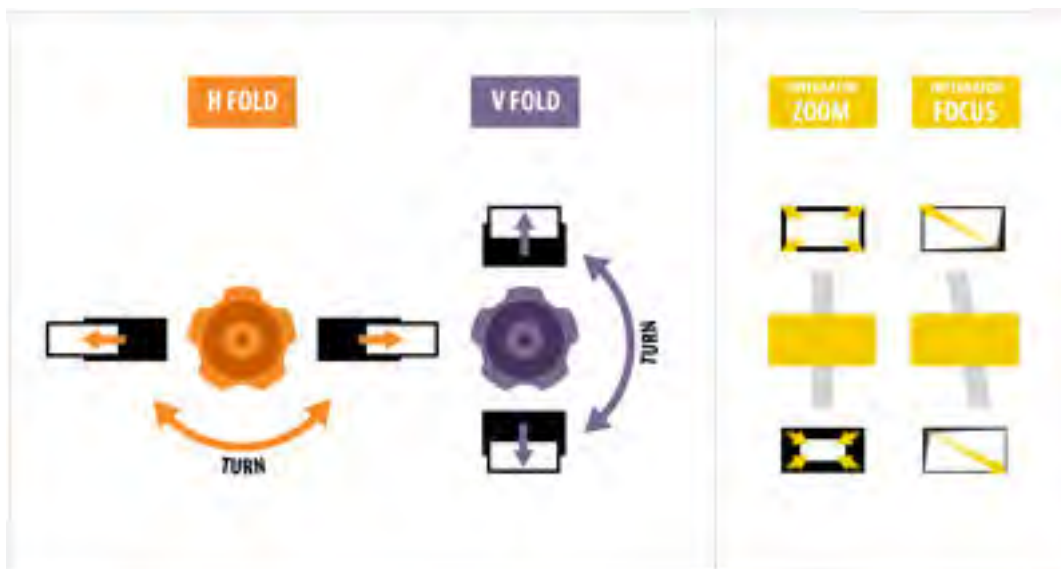

Refer to the test pattern for guidance on making the adjustments. The right panel of the test pattern provides information about the integrator zoom and focus adjustments. The left panel provides information about the fold mirror adjustments.

3. Open the Service door on the side of the projector.
4. To use the integrator rod optical controls, open the access door for the Zoom and Focus paddles.

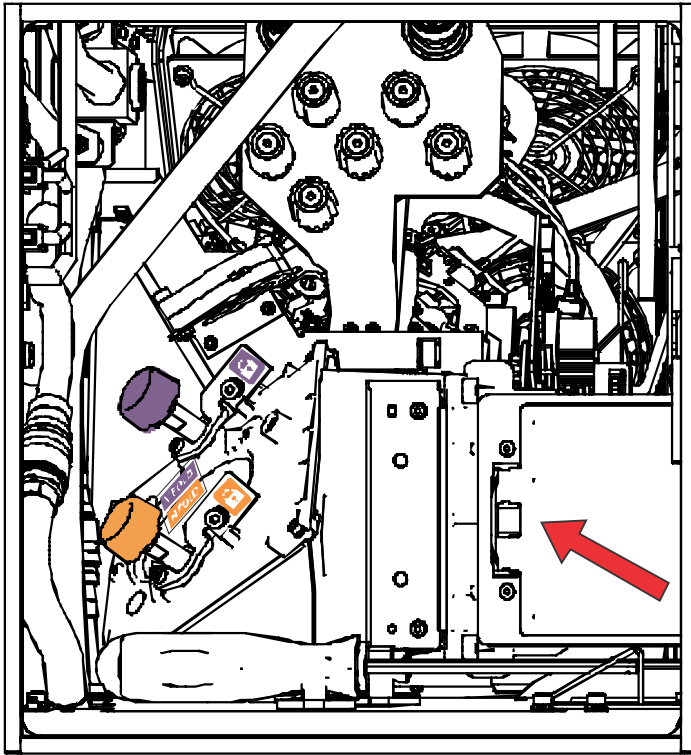

5. Loosen the lock screw for the Zoom and Focus paddles.

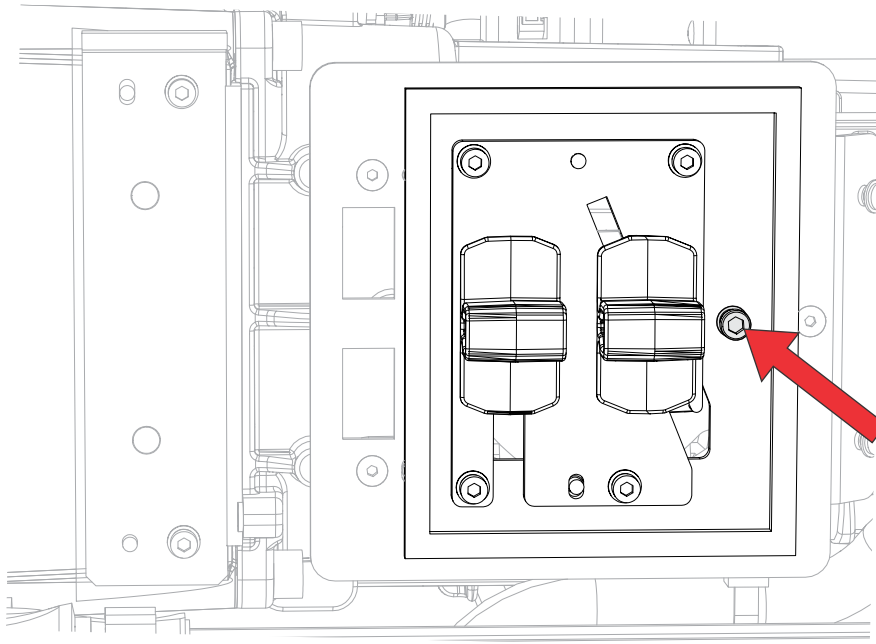

6. Set the integrator rod Zoom paddle to the minimum.
7. Loosen the fold mirror screws to unlock the fold mirror adjustment knobs.

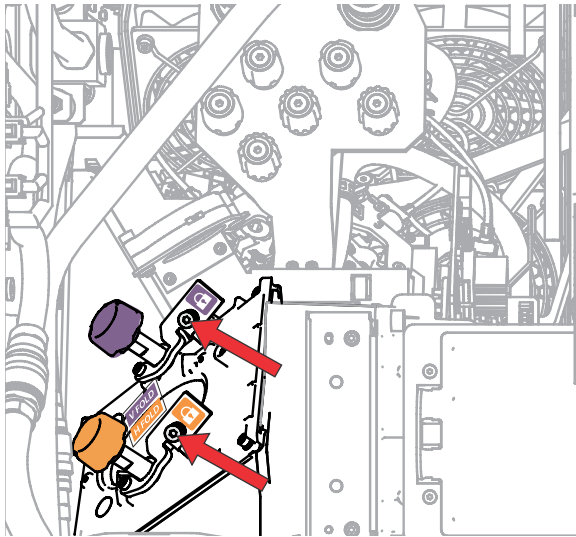

8. To make horizontal adjustments on the fold mirror, use the orange adjustment knob. To make vertical adjustments on the fold mirror, use the purple adjustment knob.

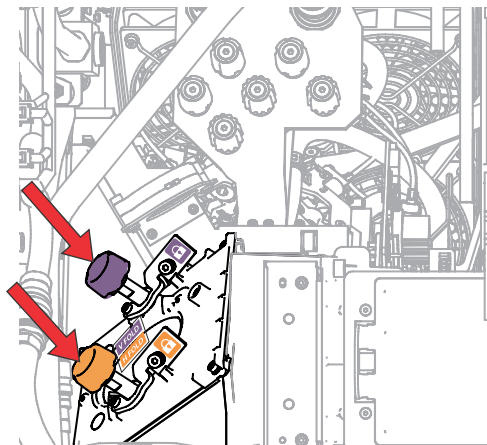

9. Adjust the fold mirror until either the top left edge or the bottom right edge of the illumination spot becomes visible on the DMD.
10. Adjust the integrator rod Focus paddle to optimize focus for one of the following:
 - Along the top edge of the image, approximately one-third across the image from the left.
 - Along the bottom edge of the image, approximately one-third across the image from the right.
11. Adjust the fold mirror to center the image on the DMD array.
12. Use the integrator rod Zoom paddle to increase the zoom until the entire active area is filled, with no dark areas at the edges or corners.
Ensure that overfill is minimized to improve DMD life and system optical efficiency for brightness.
13. Once the adjustments are complete, tighten the lock screw for the Zoom and Focus paddles, and the two fold mirror screws.
14. Close the access door for the Zoom and Focus paddles.

Adjusting the boresight

A boresight adjustment balances the tilt of the lens mount to compensate for screen-to-projector tilt.



Warning! If not avoided, the following could result in death or serious injury.

- Do not look directly into the lens when the light source is on. The extremely high brightness can cause permanent eye damage.
- FIRE HAZARD! Keep hands, clothes, and all combustible material away from the concentrated light beam of the projector.



Caution! If not avoided, the following could result in minor or moderate injury.

- This procedure must be performed by Christie qualified technicians.



When making the adjustments, set the light source to minimum power.

The following steps are intended to achieve the highest quality image distributed across the full screen.

1. Close the shutter on the projector to avoid accidental exposure to the projection beam when working in close proximity to the projection lens.
2. Using a 3 mm driver, unlock the horizontal and vertical lock screws (Lock A, B, and C). To unlock the vertical lock screw (Lock C), flip open the cover flap (G) using the screwdriver.

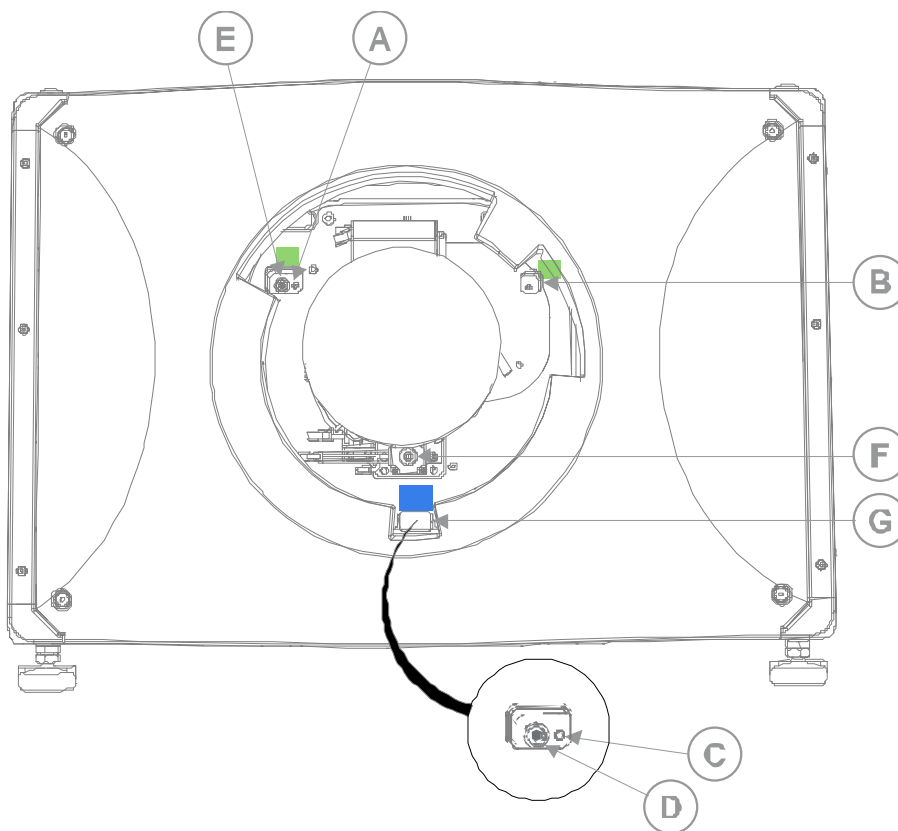

A	Horizontal lock screw (Lock A)
B	Horizontal lock screw (Lock B)

C	Vertical lock screw (Lock C)
D	Vertical boresight screw
E	Horizontal boresight screw
F	Manual focus knob
G	Cover flap

- Open the shutter on the projector.
- In the right toolbar, select **Test Patterns** .
- Select the **RGB-4K-Boresight** pattern and display it full screen.

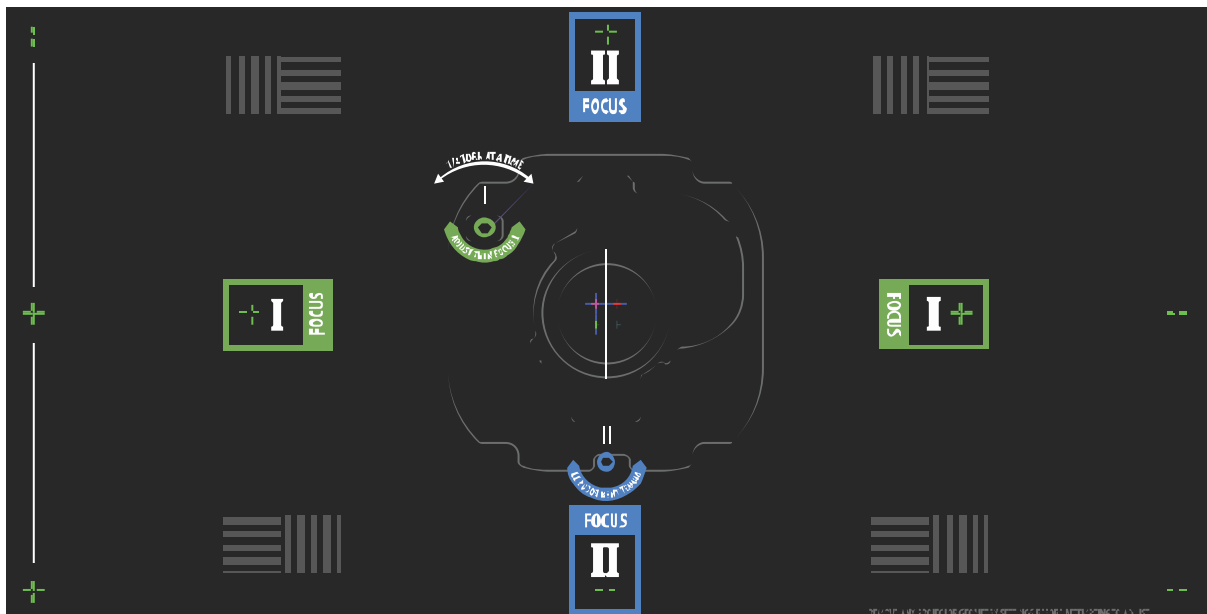

When adjusting the boresight screws, ensure that the shutter is closed to avoid accidental exposure to the projection beam when operating in close proximity to the projection lens. Open the shutter only to view the test pattern.

- Start with the horizontal boresight adjustment. Use the ILS controls to move the projection lens into the projector, or turn the manual focus knob (F) counterclockwise to slightly defocus the green cross-hair patterns (+) at the right and left edges of the test pattern.
- Use the ILS controls or turn the focus knob (F) clockwise to begin focusing the image. Watch for either the left or right cross-hair patterns (+) to come into focus.
- If the left side comes into focus first, use a 5 mm driver to turn the horizontal boresight adjustment screw (E) clockwise until the left and right are equally out of focus. If the right side comes into focus first, turn the horizontal boresight screw counterclockwise.
- Repeat steps 6 to 8 as required to obtain an even focus at the right and left edges of the screen.
- Next perform the vertical boresight adjustment. Use the ILS controls to move the projection lens into the projector, or turn the focus knob (F) counterclockwise to slightly defocus the green cross-hair patterns (+) at the top and bottom of the screen.
- Use the ILS controls or turn the focus knob (F) clockwise to begin focusing the image. Watch for either the top or bottom cross-hair patterns (+) to come into focus.

12. If the bottom comes into focus first, use a 5 mm driver to turn the vertical boresight adjustment screw (D) counterclockwise until the top and bottom are equally out of focus. If the top comes into focus first, turn the vertical boresight screw clockwise.
13. Repeat steps 10 to 12 as required to obtain an even focus at the top and bottom of the screen.
14. Once the correct focus has been achieved, lock the three lock screws.
When locking the lock screws, start with the horizontal lock screws (Lock A and Lock B) and turn them until they just touch the base. Repeat for the vertical lock screw (Lock C). Continue the gradual tightening of each screw, until all lock screws are tight.



When stabilizing image vibration, Lock B may be left locked or unlocked at the discretion of the installer.

15. If you used the focus knob (F) to make the adjustments manually, run an ILS auto calibration.
16. Fine tune the focus on cross-hair patterns **I** (horizontal) and **II** (vertical) using the ILS controls only.
The goal is to obtain good focus at the center and on all sides of the screen, including the square patterns across the screen.

Adjusting DMD convergence

A convergence problem can be identified when one or more projected colors (red, green, and blue) appears misaligned when examined with a convergence test pattern.

The three colors should overlap to form pure white lines throughout the image and one or more poorly converged individual colors may appear adjacent to some or all of the lines.

When adjusting the convergence, you are adjusting red and green to blue.



If you wear glasses with corrective lenses when performing this adjustment, ensure that you are viewing the test pattern on a straight angle through the optical axis of your glasses, and not from a tilted or angled perspective. This avoids a prismatic effect that can appear to shift convergence when viewing at an angle.

1. Before adjusting DMD convergence, ensure the projector has reached a steady operational state. If switching from a white or bright test pattern to a dark convergence test pattern, or if warming up the projector after a shutdown, allow 15 minutes for stabilization so that the optics can reach a steady state.
2. In the right toolbar, select **Test Patterns**. 
3. Select the **RGB-4K-Convergence** test pattern and display it full screen.

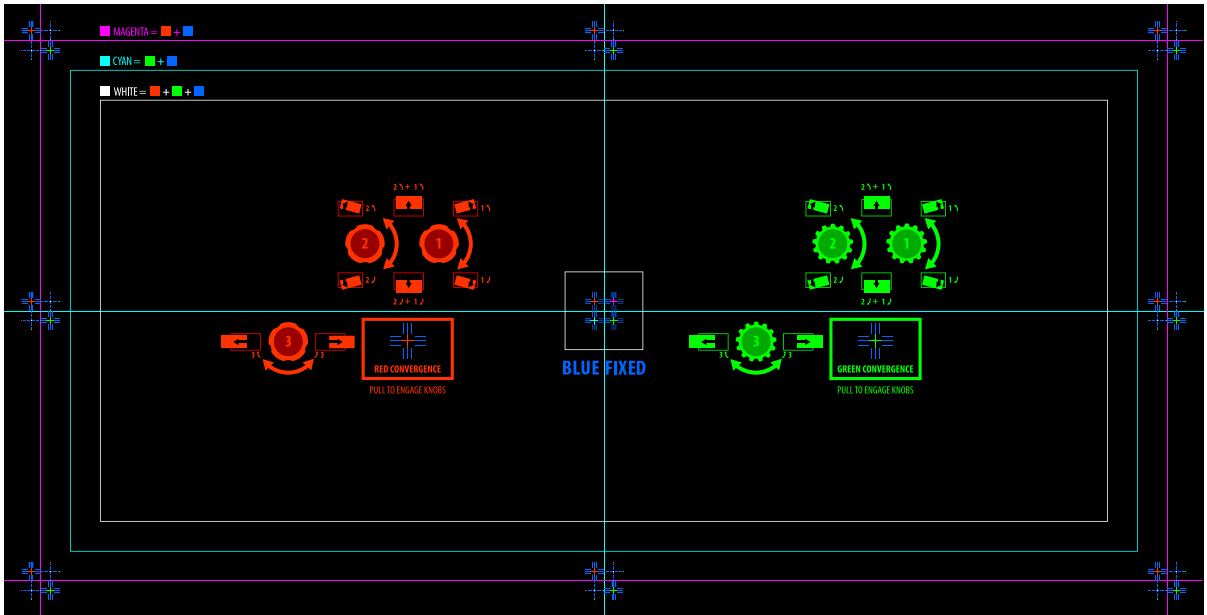

4. Open the Service door on the side of the projector.
5. To adjust the convergence knobs, use the 3 mm driver included with the projector.
If adjusting by hand without using the tool, pull out the convergence adjustment knobs to engage them.

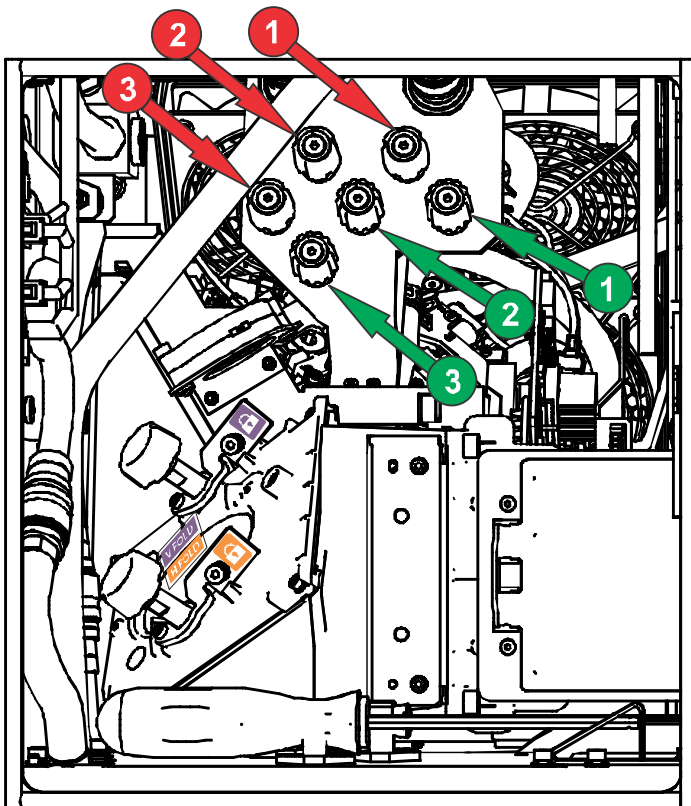

6. Use the Convergence test pattern to assist with adjusting the horizontal and vertical lines.

Horizontal adjustments are controlled by adjusting knob 3.

Vertical convergence and rotation are controlled by adjusting knobs 1 and 2. Christie recommends rotating a single knob a maximum of a quarter rotation before adjusting the second knob a quarter rotation. For example, if using one hand, turn the left knob a quarter rotation and then the right knob a quarter rotation, and so on. Adjusting a single knob for vertical or rotational adjustment to an extreme before adjusting the second knob may result in the convergence mechanism binding.



For the best stability, Christie recommends setting convergence while rotating the knobs in a clockwise direction. This may require first adjusting convergence by turning the knobs counter-clockwise, and finalizing the convergence with a clockwise approach. This applies to all knobs.

7. When complete, push in all the convergence adjustment knobs to disengage them.

Masking the screen edges

Conceal the unused edges of a screen with top or side masking.

Typically, you install top and side masking to allow a greater range of adjustment.

1. To create top masking:
 - a) Install movable flat black panels or curtains along the top edge of the screen.
 - b) Raise the curtain for flat images or lower the curtain for scope images.

Top masking theater (1.85 screens)

A	1.85 image
B	2.39 image
C	Masking moved up
D	Top masking to hide screen top

2. To create side masking:
 - a) Install movable flat black panels or curtains along each side of the screen.
 - b) Close the curtain for flat images or open the curtain and zoom for scope images.

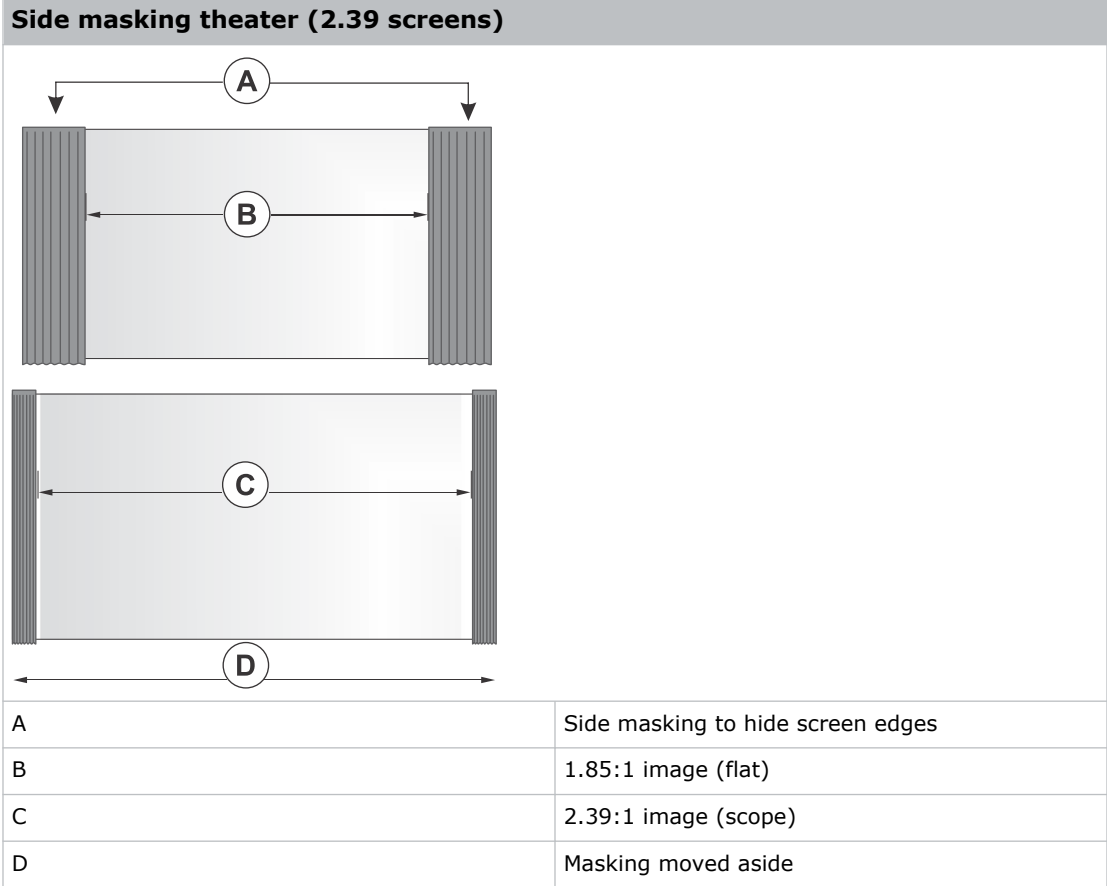

Test patterns

Use the available test patterns to assist with configuration of the projector and to diagnose any issues that may occur.

Displaying a test pattern

Display a test pattern to refine and adjust the projected image, or to diagnose and correct image issues.

1. In the right toolbar, select **Test Patterns**. 
2. Select **Full Screen** or **Uncorrected Colors**.
3. Select a test pattern.
When a test pattern is active, a blue bar appears below the test pattern icon in the right pane.
4. To display a 2D test pattern in 3D mode, select the **3D Sync** option.
The **3D Sync** option is selected automatically for 3D test patterns. 3D test patterns cannot be displayed in 2D mode.
5. To change the frame rate of the test pattern display, select from the available Frame Rate options:
 - For 2D test patterns, the available frame rates are 24, 30, 48, and 60 Frames Per Second (FPS). The default value is 24 FPS.
 - For 3D test patterns, the available frame rates are 48 and 60 FPS. The default value is 48 FPS.

Changing the frame rate of the display can assist with color measurement when working with corrected colors.

When you change the frame rate option, that option is applied to the next test pattern you select unless it is not available for that pattern. If a selected frame rate is not available, the default frame rate is applied for the test pattern display.



Turning off a test pattern

Turn off a test pattern when adjustment of the projected image is complete.

1. In the right toolbar, select **Test Patterns**. 
2. Select **Test Pattern Off**.

Importing a test pattern

Import custom test patterns to meet the specific requirements of your viewing environment.

1. In the right toolbar, select **Test Patterns**. 
2. In the upper right corner, select **Edit**.
3. Select **Import**. 
4. Browse to the location of the test pattern file.
5. Select the test pattern file.
6. Select **Accept**.
7. In the upper right corner, select **Done**.

Deleting a test pattern

Delete a test pattern that is no longer required. A test pattern with **RGB** in the name cannot be deleted.

1. In the right toolbar, select **Test Patterns**. 
2. In the upper right corner, select **Edit**.
3. Select a test pattern.
4. Select **Delete**.
5. To confirm the deletion, select **Delete**.
6. In the upper right corner, select **Done**.

Working with the scheduler



Use the scheduler to schedule playlists and automated events to play automatically on a specific date at a specific time.

Scheduling a playlist, content, or automation

Schedule a playlist, content, or automation to run automatically on a specific date and time.

On Cinema 4K-RGB projectors, the scheduler is enabled by default.

To avoid conflicts with scheduled events, the Loop option is not available when the Scheduler is on. In addition, when the Scheduler is enabled, the Loop option is disabled on any content items where it was set.

1. In the left navigation menu, select **Scheduler**.
2. To enable scheduled events, select the **Scheduler is off** slider. The color of the slider changes to green to indicate it is active.
3. To select a date for the scheduled event, select **Calendar**. 
4. Select the week.
5. Select a square below the date and next to the time that you want the event to run.
6. Select **+ New Event**.
7. Select **Playlist**, **Content**, or **Automation**.
8. Select a playlist, content, or automation item.
9. Select the start time.
10. Select the start date.
11. To repeat the event daily, weekly, or monthly:
 - a) Select the **Recurrence** slider.
 - b) Select the frequency of the recurrence. The options are daily, weekly, or monthly.
 - c) Select the days or months that you want the playlist, content, or automation event to play.
 - d) To select an end date for the schedule, select **Calendar**. 
12. To prevent the scheduled event from being overwritten, select the **Lock Event** slider. Locked events cannot be overwritten by pasted events.
13. Select **Create Event**.

Editing a scheduled event

Edit a scheduled event to modify the run time and date.

1. In the left navigation menu, select **Scheduler**.
2. In the calendar view, select the scheduled event.
3. Select **Edit**.
4. Edit the scheduled event settings.
5. Select **Update Event**.

Copying and pasting an existing scheduled event

To run a scheduled event at a different date and time, copy and paste it.

1. In the left navigation menu, select **Scheduler**.
2. In the calendar view, select the scheduled event.
3. Select **Copy**.
4. Select a square below the date and next to the time that you want the event to run.
5. Select **Paste**.
6. Adjust the any settings for the scheduled event.
7. Select **Paste Event**.

Copying and pasting scheduled events for an entire day

To run an existing full day of scheduled events on a different date, copy and paste the entire day of scheduled events.

1. In the left navigation menu, select **Scheduler**.
2. At the top of the calendar, select the day with the events you want to copy.
3. Select **Copy**.
4. At the top of the calendar, select the new target day.
5. Select **Paste**.
Only unlocked events are copied to the new day.

Cutting and pasting a scheduled event

To move an existing scheduled event to a different date and time, cut and paste it.

1. In the left navigation menu, select **Scheduler**.
2. In the calendar view, select the scheduled event.

3. Select **Cut**.
4. Select the new date in the calendar.
5. Select **Paste**.
6. Adjust the settings for the scheduled event.
7. Select **Paste Event**.
Only unlocked events are copied.

Deleting a scheduled event

Delete an individual schedule event when it is no longer required.

1. In the left navigation menu, select **Scheduler**.
2. In the calendar view, select the scheduled event.
3. Select **Delete**.
4. To confirm the deletion, select **Delete**.

Deleting scheduled events for an entire day

Delete the scheduled events for an entire day when they are no longer required.

1. In the left navigation menu, select **Scheduler**.
2. At the top of the calendar, select the target day.
3. Select **Clear Day** .
4. To confirm the change, select **Clear Day**.

Changing the day of the week the scheduler starts

Change the start day of the scheduler to match the schedule of the theater.

1. In the left navigation menu, select **Service Setup > Preferences**.
2. Select **General**.
3. In the Scheduler area, select the day of the week to start the scheduler.

Turning the scheduler off

Turn the scheduler off when you do not want scheduled events to run automatically on a specific date and time.

1. In the left navigation menu, select **Scheduler**.
2. To disable scheduled events, select the **Scheduler is on** slider.
The color of the slider changes to gray to indicate it is inactive.

Managing storage devices

Learn how to add, edit, and remove external storage devices and ingest sources.

Adding a new storage device

Add a new storage device to store and play content.

1. In the left navigation menu, select **Service Setup** > **Storage Device Setup**.
2. Select **+ New Storage Device**.
3. Complete these fields:
 - Name—The name of the storage device.
 - IP Address—The IP address of the storage device.
 - Username—The user account or ID (if required to connect to the storage device).
 - Password—The password for the user account (if required to connect to the storage device).
 - Share Folder—The folder where content is stored.
 - Drive Type—Select Content Drive or Ingest Drive.
4. To make the content drive the primary storage drive, select the **Set as Primary Drive** slider. The color of the slider changes to green to indicate it is active.
5. To test the connection to the storage device, select **Test Connection**.
6. Select **Save**.

Editing storage device settings

Edit storage device settings when device or communication settings change.

1. In the left navigation menu, select **Service Setup** > **Storage Device Setup**.
2. Select a storage device in the left pane.
3. Edit the settings in the right pane.
4. Select **Save**.

Setting a storage device as a primary drive

A primary drive is the device that is the primary source of content.

1. In the left navigation menu, select **Service Setup** > **Storage Device Setup**.

2. Select a storage device in the left pane.
3. To make the new storage device the primary storage drive, select the **Set as Primary Drive** slider.
The color of the slider changes to green to indicate it is active.
4. Select **Save**.

Deleting a storage device

Delete a storage device when it is no longer required.

1. In the left navigation menu, select **Service Setup** > **Storage Device Setup**.
2. In the left pane, select a storage device.
3. Select **Delete**. 
4. To confirm the deletion, select **Delete**.

Adding a remote ingest source

Add a remote ingest source to uploaded content from a remote storage device.

1. In the left navigation menu, select **Service Setup** > **Remote Ingest Setup**.
2. Select **+ New Ingest Source**.
3. In the Name field, type a name for the ingest source.
4. In the IP Address field, type an IP address for the ingest source.
5. In the Port field, type the port number for the ingest source.
By default, the port value is 21.
6. Select **Add**.
7. In the Username field, type the user name if required for the ingest source.
8. In the Password field, type the password if required for the ingest source.
9. Select the **Type** list and select the device type.
10. To test the connection to the ingest source, select **Test Connection**.
11. To save the configuration, select **Save**.

Editing remote ingest source settings

Edit the settings of remote ingest sources when device or communication settings change.

1. In the left navigation menu, select **Service Setup** > **Remote Ingest Setup**.
2. In the left pane, select a remote ingest source.
3. Edit the settings displayed in the right pane.
4. Select **Save**.

Deleting a remote ingest source

Delete a remote ingest source when it is no longer required.



1. In the left navigation menu, tap **Service Setup** > **Remote Ingest Setup**.
2. In the left pane, tap a remote ingest source.
3. Tap **Delete**. 
4. To confirm the deletion, tap **Delete**.

Managing projector setting files

Projector setting files store projector settings. When a projector setting file is associated with a channel, the projector settings are automatically adjusted to match the requirements of the content.

Creating a 3D file

Create a 3D file if you are playing 3D content on a single projector or using active 3D with multiple projectors.

1. In the left navigation menu, select **Image Settings > 3D File Setup**.
2. Select **Create 3D File**. 
3. Type a name for the 3D file and select **Create**.
4. In the General Settings area, complete these fields:
 - **3D Delay**—Creates a delay to allow the 3D system to synchronize the output and reduce on screen artifacts.
 - **Invert 3D Sync Polarity**—Reverses 3D stereo sync output (left eye = right eye and right eye = left eye).
5. In the Frame Rate Settings area, complete these fields:
 - **Dark Time**—Creates a blank time interval in microseconds (μs) between left and right frames to allow for LCD shutter glasses, Z screen, or rotating 3D wheel to synchronize the output.
 - **Output Delay** —The time interval in microseconds (μs) when an image is not displayed. Offset 3D stereo sync output in relation to the dark time interval. A positive offset adds a delay and a negative offset starts playback early.
 - **Phase Delay**—The degree of reference between the left and right sync output.
 - **Multiplier**—Sets the number of frames to display per number of frames that form one complete image. You can increase the display frame rate to reduce flicker from your source.
6. Select **Save**. 

Editing an existing 3D file

Edit an existing 3D file to match the settings of the 3D hardware.

1. In the left navigation menu, select **Image Settings > 3D File Setup**.
2. In the 3D File list, select a file.

3. Edit the 3D file settings.
4. Select **Save**. 

Copying a 3D file

Copy an existing 3D file to create a new 3D file with similar settings.

1. In the left navigation menu, select **Image Settings > 3D File Setup**.
2. In the 3D File list, select a file.
3. Select **Save As**. 
4. Type a new name for the file.
5. Select **Save**.

Deleting a 3D file

Delete a 3D file when it is no longer required.

1. In the left navigation menu, select **Image Settings > 3D File Setup**.
2. In the 3D File list, select a file.
3. Select **Delete**. 
4. To confirm the deletion, select **Delete**.

Managing audio settings

Learn how to enable and modify projector audio settings.

Setting the global audio delay

The global audio delay setting increases or decreases the audio delay.

1. In the left navigation menu, tap **Service Setup** > **Audio Setup**.
2. On the **Global Settings** tab, in the Global Audio Delay area, select one of these options:
 - To increase the audio delay, tap **Up**. ^
 - To decrease the audio delay, tap **Down**. v

Setting the audio output rate

Adjust the audio output rate to match the output of the audio device.

1. In the left navigation menu, tap **Service Setup** > **Audio Setup**.
2. On the **Global Settings** tab, in the Audio Output Rate area, select one of these options:
 - Automatic
 - 48 kHz
 - 96 kHz

Mapping channels

Use the Channel Mapping tab to map the Digital Cinema Package (DCP) audio channels to the AES outputs. Interop is the most common audio setting.

1. In the left navigation menu, tap **Service Setup** > **Audio Setup**.
2. Tap the **Channel Mapping** tab.
3. In the Channel Format list, select an audio format.
The selection in the Channel Format list does not determine the audio format. The content determines the audio format. For example, if you select SMPTE 7.1 DS and Interop is specified in the content, the Interop audio settings are applied when the content plays.
4. Select the channel that matches the speaker specified in the *Interop Channel Mapping Guide*.
5. For any speakers not being used, select **Not Used**.
6. To test the channel mapping setting, tap **Test**.

Enabling Dolby Atmos

To play content with Dolby Atmos audio, enable Dolby Atmos.

1. Select **Service Setup > Audio Setup**.
2. Select the **Dolby Atmos Configuration** tab.
3. Select the **Enable Dolby Atmos** slider.
The color of the slider changes to green to indicate it is active.
4. In the Control IP field, type the control IP address.
5. In the Input IP field, type the input IP address.
6. To test Dolby Atmos connectivity, select **Test Connection**.
7. Select **Save**.

Editing Dolby Atmos settings

Edit Dolby Atmos settings when device settings change.

1. Select **Service Setup > Audio Setup**.
2. Select the **Dolby Atmos Configuration** tab.
3. Edit the Control IP and Input IP fields.
4. To test Dolby Atmos connectivity, select **Test Connection**.
5. Select **Save**.

Disabling Dolby Atmos

Disable Dolby Atmos when Dolby Atmos audio playback is no longer required.

1. Tap **Service Setup > Audio Setup**.
2. Tap the **Dolby Atmos Configuration** tab.
3. Tap the **Enable Dolby Atmos** slider.
The color of the slider changes to gray to indicate it is inactive.
4. Tap **Save**.

Setting up multiple projectors

Learn how to add, modify, and remove primary projectors and secondary projectors.

Enabling multiple projectors

Enable multiple projectors to display 3D or HDR content.

1. In the left navigation menu, select **Service Setup** > **Multi-Projector Setup**.
2. Select the **Multi-Projector Control** slider.
The color of the slider changes to green to indicate it is active.
3. Select the **Active 3D Glasses** slider if you are using active 3D glasses and want to send left and right images to multiple projectors.
If you select this option, you cannot change the eye selection setting.
4. In the Master Eye Selection list, select **Right** or **Left** for the primary projector.
This option is not available when **Active 3D Glasses** is selected.
5. If using a Christie NAS device, select the **Multi-Projector Sync of Content** slider to automatically synchronize ingested content on the primary projector to all secondary projectors.
The color of the slider changes to green to indicate it is active.



For more information on synchronizing content using multiple NAS devices, see the *Christie NAS-S3 Installation and Setup Instruction Sheet P/N: 020-102537-XX*.

Adding a secondary projector

Add a secondary projector to display 3D or HDR content.

1. In the left navigation menu, select **Service Setup** > **Multi-Projector Setup**.
2. Select **+ New Slave Projector**.
This option is available only when the **Multi-Projector Control** slider is selected.
3. Type a name and IP address for the projector.
4. Select **Add**.
5. In the Eye Selection column, select **Right** or **Left**.
This option is not available when **Active 3D Glasses** is selected.

Disabling multiple projectors

Disable multi-projector settings when the second projector is not required to display content.

1. In the left navigation menu, select **Service Setup** > **Multi-Projector Setup**.
2. Select the **Multi-Projector Control** slider.
The color of the slider changes to gray to indicate it is inactive.

Disabling a secondary projector

Disable a secondary projector when it is no longer required or when it is replaced by another projector.

1. In the left navigation menu, select **Service Setup** > **Multi-Projector Setup**.
2. Select the slider in the **Enabled** column of the secondary projector you want to disable.
The color of the slider changes to gray to indicate it is inactive.

Deleting a secondary projector

Delete a secondary projector from a multi-projector configuration when it is no longer required or when it is replaced by another projector.

1. In the left navigation menu, select **Service Setup** > **Multi-Projector Setup**.
2. In the Delete column of the secondary projector you want to delete, select **Delete**. 
3. To confirm the deletion, select **Delete**.

Automation

You use automation to control playback, the projector, and external devices. This section provides instructions for managing and defining:

- **Macros** - A macro is a list of actions that you define. For example, opening the curtains or turning on the house lights at the end of playback. A macro can be activated by a global trigger, or it can be added to a playlist.
- **Device Input Triggers** - Input cues wait for events such as a general purpose input (GPI) state change or an Ethernet message received on the projector management IP address port 5111. An input cue in a playlist delays playback until an event occurs.
- **Global Triggers** - A global trigger combines an input cue with a macro. When the predefined event for the input cue occurs, the output macro is triggered. For example, a fire alarm input signal could cause playback to stop and the house lights to come on. A global trigger is always active and is not dependent on specific playlist definitions.

Available macro actions

These are the macro actions that are available to control automated events:

Action Item	Available Actions	Description
Automation	Set Global	Allows you to set a global variable that can be used in automation scripting (intended for advanced scripting by Christie)
	Print	Generates a projector log entry when an automation macro runs
	Get Global	Allows the automation script to read the value of a global variable (intended for advanced scripting by Christie)
	Set GPO	Sets the specified GPO pin to high or low
	Pulse GPO	Pulses the specified GPO pin
	Get GPI	Allows an automation script to read the GPI state (intended for advanced scripting by Christie)
	Delay	Delays macro execution
	Wait On GPI	Pauses the automation script and waits for the specified GPI event to enter the specified state
Playback	Pause	Pauses playback
	Stop	Stops playback
	Play	Starts or resumes playback
	Toggle	Pauses playback if content is playing OR resumes playback if content is paused

Action Item	Available Actions	Description
	Disable Subtitle	Disables subtitles for the current content and onward
	Jog	Moves content forward by the time specified
Projector	Douser Open	Opens the douser (shutter)
	Douser Close	Closes the douser (shutter)
	Light On	Turns the light on
	Light Off	Turns the light off
	Standby	Puts the projector in standby mode
	Channel	Selects a specific projector channel
	Revert Warp File	Reverts the active warp file to its previous settings
	Full Power	Places the projector in full power mode
	Wait	Delays the execution of a macro

Fire alarm macro

By default, the projector is configured with a macro that uses a building fire alarm as the trigger.

If the projector is connected to the building's fire alarm system (recommended installation), the default `FIRE_ALARM` macro performs the following actions in sequence:

1. Stops the playback of content.
2. Puts the projector into Standby mode.

You can also create a custom macro that uses the fire alarm trigger or edit the default fire alarm macro to perform other actions as needed.

Related information

Adding an action item to an existing macro (on page 86)

Creating a macro (on page 85)

Christie ACT actions

These are the available built-in commands for the Christie ACT:

Command	Description
Buzzer	Activates the buzzer for the specified time (in milliseconds)
Button	Simulates pressing or holding the ACT button
Pulse Relay	Sends a pulse to a specific relay
Open Relay	Opens a specific relay
Close Relay	Closes a specific relay
Pulse GPO	Sends a pulse to a specific GPO pin

Command	Description
Set All GPOs	Sets the values for all GPO pins
Run Script	Runs a script on the Christie ACT
Flash LED	Causes a specific LED to flash
Set All LEDs	Sets values for all of the LEDs

JNIOR actions

These are the available built-in commands for JNIOR devices:

Command	Description
Open Relay	Opens a specific JNIOR relay
Close Relay	Closes a specific JNIOR relay
Pulse Relay	Sends a pulse to a specific JNIOR relay for the specified time (in milliseconds)
Execute Macro	Executes a JNIOR macro

You can create macros on the JNIOR device and call them using the `Execute Macro` command. Make sure you use `\\0D` for a carriage return and `\\0A` for a line feed.

To create and run macros on the JNIOR, use the JNIOR Support Tool to enable and configure the Cinema.JNIOR application. It is recommended that you install Cinema.JNIOR version 2.22.1115.1501 or later. For additional information, see INTEG Process Group (www.integpg.com). Port 9200 is the default Ethernet port for sending automation commands to the JNIOR.

Dolby Cinema processor actions

These are the available built-in commands for Dolby CP650, CP750, and CP850 devices:

Command	Description
Mute On/Mute Off	Enables or disables muting
Set Format (CP650 only)	Selects the format
Set Fader Level	Sets the fader level
Send Message (CP850 only)	Sends the specified message

If you need to control additional functions and a built-in command is not available, send a command string in a macro. For example, send this command to enable surround boost on the Dolby CP750:
`cp750.sys.surround_boost 1\\0D`

Make sure that you include a carriage return (`\\0D`) at the end of each command. For more information about controlling other features with serial commands, see the Dolby CP750 documentation.

The default Ethernet port for sending automation commands to the Dolby CP650 is port 61412. For Dolby CP750 and CP850, the default Ethernet port is port 61408.



SKA-3D actions

These are the available built-in commands for SKA-3D devices:

Command	Description
Set Audio Input Channel	Sets the audio input channel
Mute On/Mute Off	Enables or disables muting
Set Master Volume	Sets the overall volume for the system
Set Video Input Channel	Sets the video input channel
Active Trigger Input	Controls eight SKA-3D presets To use this command, a trigger input must be associated with each of the SKA-3D presets

Creating a macro

Create a macro to make the projector perform a specific list of actions.

1. In the left navigation menu, select **Automation > Macro Editor**.
2. In the right pane, select **Create New Macro**. 
3. Type a name for the macro.
The Name field cannot contain spaces.
4. Select the macro type.
5. Select **Create**.
6. Add an action item to the macro:
 - a) In the left pane, expand the My Auditorium list.
 - b) Under Automation, Playback, or Projector, select the action item.
7. To save the macro, select **Save**. 
8. To test the macro, select **Test**.

Running a macro

Run a macro to have the projector perform a specific list of actions.

1. In the right toolbar of the touch panel, select **Run Macro**. 
2. Select a macro.

Adding an action item to an existing macro

Add an action item to a macro to have the projector perform an additional action when the macro runs.

1. In the left navigation menu, select **Automation > Macro Editor**.
2. In the top right pane, select a macro from the list.
3. Add an action item to the macro:
 - a) In the left pane, expand the **My Auditorium** list.
 - b) Under Automation, Playback, or Projector, select the action item.
4. To save the macro, select **Save** .
5. To test the macro, select **Test**.

Related information

Fire alarm macro (on page 83)

Adding a macro to an existing macro

Combine macros to have the projector complete a complex set of actions.

1. In the left navigation menu, select **Automation > Macro Editor**.
2. From the list in the top right pane, select a macro.
3. In the left pane, expand the macro list.
4. Select a macro.
5. Sap **Save** .

Deleting a macro

Delete macros when they are no longer required.

1. In the left navigation menu, select **Automation > Macro Editor**.
2. From the list in the top right pane, select a macro.
3. Select **Delete**. .
4. To confirm the deletion, select **Delete**.

Adding an automation device to your auditorium

Add an automation device so it can be controlled remotely and can communicate with other theater hardware.

1. In the left navigation menu, select **Automation > My Auditorium Devices**.
2. Select **+ New Device**.
3. In the Name field, type a name for the device.

4. In the Device Type list, select the device type.
5. In the Select Device list, select the device.
6. Select **Add**.
7. Complete these fields:
 - IP Address—The IP address of the automation device.
 - Port—The port used by the automation device to communicate with the projector.
 - Username—The username used to access the automation device.
 - Password—The password used to access the automation device.
 - Keep Alive Message—The message value that is sent to the automation device to ensure the projector is not disconnected when inactive.
 - Keep Alive Interval (ms)—The time interval (in milliseconds) for sending the Keep Alive Message to the automation device.
8. Select **Save**.
The added device is displayed in the list of auditorium devices in the Macro Editor.

Modifying automation device settings

Modify the settings of automation devices when parameters such as the user name or password change. If the settings are not updated, the automation device might be unable to communicate with other theater hardware or be controlled remotely.

1. In the left navigation menu, select **Automation > My Auditorium Devices**.
2. In the left pane, select an automation device.
3. Modify these fields:
 - IP Address—The IP address of the automation device.
 - Port—The port used by the automation device to communicate with the projector.
 - Username—The username used to access the automation device.
 - Password—The password used to access the automation device.
 - Keep Alive Message—The message value that is sent to the automation device to ensure the projector is not disconnected when inactive.
 - Keep Alive Interval (ms)—The time interval (in milliseconds) for sending the Keep Alive Message to the automation device.
4. Select **Save**.

Removing an automation device from your auditorium

Remove an automation device when it is no longer required, or it has been physically removed from the theater.

1. In the left navigation menu, select **Automation > My Auditorium Devices**.
2. In the left pane, select an automation device.

3. Select **Delete**. 
4. To confirm the deletion, select **Delete**.

Creating a new playlist trigger

Create new playlist triggers to activate an automation device in a playlist.

1. In the left navigation menu, select **Automation > Device Input Triggers**.
2. Select the **Playlist Trigger** tab.
3. Select **+ New Playlist Trigger**.
4. Complete the Name, Device Source, and Resume Playback On fields.
The Name field cannot contain spaces.
5. Select **Add**.

Editing existing playlist trigger settings

Edit playlist trigger settings to change the playlist trigger behavior.

1. In the left navigation menu, select **Automation > Device Input Triggers**.
2. Select the **Playlist Triggers** tab.
3. To the right of the playlist trigger you want to edit, select **Edit**. 
4. Edit the playlist trigger settings.
5. Select **Save**.

Deleting a playlist trigger

Delete a playlist trigger when it is no longer required.

1. Tap **Automation > Device Input Triggers**.
2. Tap the **Playlist Triggers** tab.
3. To the right of the playlist trigger, tap **Delete**. 
4. To confirm the deletion, tap **Delete**.

Creating a new global trigger

Create a global trigger to trigger an output macro. For example, a fire alarm input signal could cause playback to stop and the house lights to come on. A global trigger is always active and is not dependent on specific playlist definitions.

1. In the left navigation menu, select **Automation > Device Input Triggers**.
2. Select the **Global Triggers** tab.
3. Select **+ New Global Trigger**.

4. Complete the Name, Source, and Trigger Event fields.
The Name field cannot contain spaces.
5. In the Macro Name list, select the macro that will run on trigger detection.
6. Select **Add**.

Editing existing global trigger settings

Edit the settings of an existing global trigger to change its behavior.

1. In the left navigation menu, select **Automation** > **Device Input Triggers**.
2. Select the **Global Triggers** tab.
3. To the right of the global trigger you want to edit, select **Edit** .
4. Edit the global trigger settings.
5. Select **Save**.

Deleting a global trigger

Delete a global trigger when it is no longer required.

1. In the left navigation menu, select **Automation** > **Device Input Triggers**.
2. Select the **Global Triggers** tab.
3. To the right of the global trigger, select **Delete** .
4. To confirm the deletion, select **Delete**.

Importing a device library

A device library contains commands that are used to control a specific device.

1. In the left navigation menu, select **Automation** > **Device Libraries**.
2. select **Import Device Library**.
3. Browse to the location of the device library file.
4. Select the file and select **Accept**.

Viewing a device library

View device libraries to determine if a library exists for the network device.

1. Import the device library.
2. In the left navigation menu, select **Automation** > **Device Libraries**.
3. To the right of the device in the View Library column, select **View Library**. 

Review the list of actions available for the device.

Deleting a device library

Delete a device library when it is no longer required.

1. In the left navigation menu, select **Automation** > **Device Libraries**.
2. To the right of the device library, select **Delete**. 
3. To confirm the deletion, select **Delete**.

Enhancements and licensing

Learn about importing licenses and activating product enhancements.

Enabling an enhancement

After importing a license, it must be enabled to activate the new functionality.

1. Select **Service Setup > Enhancements**.
2. In the Enable column, select the **Enhancement** slider.
The color of the slider changes to green to indicate it is active.

Enabling RealD 3D EQ

If you are using RealD technology to display 3D content, you must enable the RealD 3D EQ configuration file.

1. Obtain the license file from RealD.
2. Select **Image Settings > RealD 3D EQ File Setup**.
3. To upload the RealD license file, select **Browse** and navigate to the file location.
4. To open the license file, select the file (.reald) and select **Accept**.

Importing a rental license file

If your projector is a rental unit provided by a vendor, you must import a rental license to enable certain features.

Depending on your customer rental agreement, the vendor may provide access to the following features:

- illumination
- HDMI

Your entitlement to use the features may be unrestricted, or may be assigned for a specified date range or number of hours. To obtain the rental license, download the file provided by the vendor.

1. In the right toolbar, select **Rental Mode Key**. 
2. In the Rental Licenses window, select **Import License**.
3. In the Open File dialog, navigate to the folder containing the license ZIP file and select the file from the list.

4. To import the license ZIP file, select **Accept**.

The license file is extracted and the following customer information is added to the projector's system:

- Name
- Address
- Phone number
- Email

The system displays the entitlement information for illumination and HDMI. When an entitlement is nearing expiration, the system displays an alert on the Rental Mode Key icon.



Backing up, restoring, and upgrading files

Learn how to back up, restore, and upgrade projector files.

Creating a new backup file

Create a new backup file to restore projector settings if a failure occurs.

1. In the left navigation menu, select **Service Setup** > **Backup and Restore**.
2. Select **New Backup**.
3. Type a name for the backup file and select **Backup**.

Exporting a backup file

A disaster recovery plan can include exporting backup files to another location.

1. In the left navigation menu, select **Service Setup** > **Backup and Restore**.
2. Insert a USB flash drive into the **Management USB** port on the projector communication board.
3. Select a backup file and select **Export**. 
4. Select to move up through the file directory.
5. Select to create a new folder.
6. In the Name field, type a name for the backup file.
7. Select **Accept**.

Importing a backup file

Import a backup file to restore projector settings.

1. In the left navigation menu, select **Service Setup** > **Backup and Restore**.
2. Insert a USB flash drive into the **Management USB** port on the projector communication board.
3. Select **Import Backup**.
4. Browse to the location of the file or enter a name for the backup file in the Name field.
5. Select the file and select **Accept**.
6. If the file already exists, in the confirmation dialog select **Overwrite**.

Sorting backup files by name and date created

Locate a backup file with a specific name or creation date.

1. In the left navigation menu, select **Service Setup** > **Backup and Restore**.
2. Sort the backup files:
 - To sort the backup files by name, select the **Backup File Name** heading.
 - To sort the files by the date they were created, select the **Date Created** heading.

Deleting a backup file

Delete a backup file if it is no longer required or is uploaded in error.

1. In the left navigation menu, select **Service Setup** > **Backup and Restore**.
2. Select a backup file and select **Delete** .
3. To confirm, select **Delete**.

Adding an upgrade package

An upgrade package is used to upgrade the projector software.

A maximum of 10 upgrade packages can be stored. When you add an upgrade package that exceeds this limit, the system deletes the upgrade package that was last used.

1. In the left navigation menu, select **Service Setup** > **System Upgrade**.
A list of upgrade files appears in the left pane.
2. Select **+ Add New Package**.
3. Browse to the location of the upgrade package.
4. Type a name for the upgrade package and select **Accept**.

Installing an upgrade package

Install an upgrade package to update the projector software.

1. In the left navigation menu, tap **Service Setup** > **System Upgrade**.
2. In the list of packages, tap an upgrade package.
3. In the right pane, select one of these options:
 - **Upgrade Differences Only**—Upgrades system components that are newer or older than the currently installed version.
 - **Force Upgrade All**—Upgrades all components in the upgrade package.
 - **Factory Upgrade**—Removes all existing configurations and upgrades all components.
4. Tap **Upgrade**.
5. To confirm, tap **Upgrade**.

Comparing upgrade packages

Compare upgrade packages to view the differences between them.

1. In the left navigation menu, select **Service Setup** > **System Upgrade**.
2. In the list of packages, select an upgrade package.
The differences between the current and the selected upgrade package are displayed in the right pane. Differences are identified with a yellow exclamation mark.

Deleting an upgrade package

Delete an upgrade package that is no longer required.

1. In the left navigation menu, tap **Service Setup** > **System Upgrade**.
2. In the list of packages, tap an upgrade package.
3. Tap **Delete**. 
4. To confirm the deletion, tap **Delete**.

Restoring settings from a backup file

Restore projector settings from a backup file.

1. In the left navigation menu, select **Service Setup** > **Backup and Restore**.
2. Select a backup file and select **Restore** .
3. Select the settings you want to restore and select **Restore**.
4. Select **OK**.

Restoring factory default settings

Restoring factory settings removes all custom projector settings.

1. In the left navigation menu, select **Service Setup** > **Backup and Restore**.
2. Select **Factory Restore**.
3. Select the settings you want to restore and select **Restore**.
4. Select **OK**.

Accessing projector diagnostics

Learn how to access projector system logs and run diagnostic utilities.

Retrieving and downloading system logs

System logs can aid with the identification and correction of projector faults.

1. In the left navigation menu, select **Diagnostics > System Logs/Interrogator**.
2. In the From list, select a start date for the logs.
3. In the To list, select an end date for the logs.
4. In the Log Source list, select a log type. For example, **Projector**.
5. Select **Search**.
6. To sort log files by type, message, or date, select a column heading.
7. To download the Security Manager (SM) report:
 - a) Select **Download SM Report**. The system generates the report.
 - b) Browse to the location where you want to save the report file.
 - c) Type a name for the report file in the Name field.
 - d) Select **Accept**.

Running the projector interrogator

Run the interrogator to identify and correct projector faults.

1. Insert a USB flash drive into the **Management USB** port on the projector communication board.
2. In the left navigation menu, select **Diagnostics > System Logs/Interrogator**.
3. Select **Run Interrogator**.
4. In the confirmation dialog, select **Interrogate**.

By default, the interrogator excludes warp files to limit the size of the log file output. To include warp files in the interrogator log, select the option for **Include Warp Files**. Including warp files significantly increases the size of the interrogator log file (ZIP).
5. Browse to the location where you want the interrogator file to be saved.
6. In the Name field, type a name for the interrogator file.
7. Select **Accept**.

Viewing laser diagnostic information

Find diagnostic information on the laser optical sub-system.

1. In the left navigation menu, select **Laser Settings > Laser Diagnostics**.
2. Review the detailed information for the following:
 - model
 - version
 - serial numbers
 - power health
 - drivers
 - temperature

Downloading a certificate

Follow these steps to download a required certificate.

1. In the left navigation menu, select **About**.
2. In the certificate list, select one of the following certificates:
 - Projector Certificate
 - SMS Certificate
 - SM Certificate (used by distributors to generate KDM keys)
 - Log Signer Certificate
3. Select **Download**.
4. In the Name field, type a name for the certificate file.
5. Select **Accept**.

Regulatory

This product conforms to the latest regulations and standards related to product safety, environmental, and electromagnetic compatibility (EMC) requirements.

Safety

- ANSI/UL 60950-1 – Information Technology Equipment – Safety – Part 1: General Requirements
- CAN/CSA C22.2 No. 60950-1-07 – Information Technology Equipment – Safety – Part 1: General Requirements
- IEC/EN 60825-1 – Safety of Laser Products – Part 1: Equipment Classification and Requirements
- IEC 60950-1 IEC/EN 60950-1 – Information Technology Equipment – Safety – Part 1: General Requirements
- IEC/EN 62471-5 – Photobiological Safety of Lamps and Lamp Systems – Part 5: Image projectors

Electro-magnetic compatibility

Emissions

- CAN ICES-003 (A)/NMB-003 (A) – Information Technology Equipment (Including Digital Apparatus) – Limits and Methods of Measurement
- CISPR 32/EN 55032, Class A – Electromagnetic Compatibility of Multimedia Equipment – Emission Requirements
- FCC CFR47, Part 15, Subpart B, Class A – Unintentional Radiators
- IEC 61000-3-2/EN61000-3-2: Limits for harmonic current emissions for equipment with input current ≤ 16 A
- IEC 61000-3-3/EN61000-3-3: Limitations of Voltage Changes, Voltage Fluctuations, and Flicker input current ≤ 16 A
- IEC 61000-3-11/EN61000-3-11: Limitations of Voltage Changes, Voltage Fluctuations, and Flicker for equipment with rated current ≤ 75 A
- IEC 61000-3-12/EN61000-3-12: Limits for harmonic current emissions for equipment for systems with input current > 16 A and ≤ 75 A per phase

Immunity

- CISPR 24/EN55024 EMC Requirements – Information Technology Equipment

Environmental

- China Ministry of Information Industry (along with 7 other Government Agencies) Order No.32 (01/2016) on the control of pollution caused by electronic information products, hazardous substances concentration limits (GB/T 26572 - 2011), and the applicable product marking requirement (SJ/T 11364 - 2014).
- EU Directive (2011/65/EU) on the restriction of the uses of certain hazardous substances (RoHS) in electrical and electronic equipment and the applicable official amendment(s).
- EU Directive (2012/19/EU) on waste and electrical and electronic equipment (WEEE) and the applicable official amendment(s).
- Regulation (EC) No. 1907/2006 on the registration, evaluation, authorization and restriction of chemicals (REACH) and the applicable official amendment(s).

Corporate offices

Christie Digital Systems USA, Inc.
ph: 714 236 8610

Christie Digital Systems Canada Inc.
ph: 519 744 8005

Worldwide offices

Africa
ph: +27 (0)11 510 0094

Australia
ph: +61 (0) 7 3624 4888

Brazil
ph: +55 (11) 2548 4753

China (Beijing)
ph: +86 10 6561 0240

China (Shanghai)
ph: +86 21 6030 0500

Columbia
ph: +57 (318) 447 3179

Germany
ph: +49 (0) 221 99512 0

India
ph: +91 (080) 6708 9999

Japan (Tokyo)
ph: 81 3 3599 7481

Korea (Seoul)
ph: +82 2 702 1601

Mexico
ph: +52 55 4744 1790

Singapore
ph: +65 6877 8737

Spain
ph: +34 91 633 9990

Middle East
ph: +971 (0) 503 6800

United Kingdom
ph: +44 (0) 118 977 8000

United States (Arizona)
ph: 602 943 5700

Independent sales consultant offices

Italy
ph: +39 (0) 2 9902 1161

Russia
ph: +36 (0) 1 47 48 100



For the most current technical documentation, visit www.christiedigital.com.

