

LWU701i/LW751i/LX801i/LWU601i/LW651i

**User's Manual (detailed)
Instant Stack Guide**

020-000788-03
LIT MAN USR D2 ISG

CHRISTIE®

LWU701i/LW751i/LX801i LWU601i/LW651i User's Manual (detailed) Instant Stack Guide

Thank you for purchasing this projector.

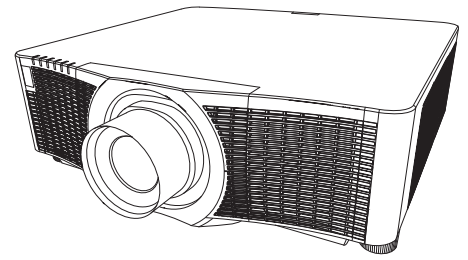

Features

This projector can be used with another projector of the same model to project an image on the same screen using the Instant Stack feature.

The two projectors can be operated simultaneously to make the image brighter. Moreover, if you connect two projectors with RS-232C cross-over cable, it turns to an intellectual stacking system. The two projectors can work alternately by themselves, and once one projector has an accident the other voluntarily starts to work to keep your presentation going.

These features, generically called Instant Stack, provide you with the broad use.

About this manual

Various symbols are used in this manual. The meanings of these symbols are described below.

- ⚠ **WARNING** This symbol indicates information that, if ignored, could possibly result in personal injury or even death due to incorrect handling.
- ⚠ **CAUTION** This symbol indicates information that, if ignored, could possibly result in personal injury or physical damage due to incorrect handling.

NOTICE This entry notices of fear of causing trouble.

📖 Refer to the pages written following this symbol.



⚠ **WARNING** ► Before using this projector, be sure to read all manuals for this projector. After reading them, store them in a safe place for future reference.
► Follow all the instructions in the manuals or on the projector. The manufacturer assumes no responsibility for any damage caused by mishandling that is beyond normal usage defined in the manuals.

NOTE • The information in this manual is subject to change without notice.
• The illustrations in this manual are for illustrative purposes. They may differ slightly from your projector.
• The manufacturer assumes no responsibility for any errors that may appear in this manual.
• The reproduction, transfer or copy of all or any part of this document is not permitted without express written consent.

Trademark acknowledgment

All the trademarks in this manual are the properties of their respective owners.

Contents

			
1. Introduction	3	3. STACK menu settings	13
1.1 Basic information and preparations	3	3.1 Displaying STACK menu	13
Instant Stack	3	3.2 Selecting Main, Sub or off	14
Intellectual Stack and Simple Stack.....	3	3.3 Selecting lamp operation mode ..	15
Remote control for Intellectual Stack and Simple Stack	3	3.4 Selecting lamp switching mode ..	17
2. Installation	5	3.5 Selecting input source for Sub....	18
2.1 Preparing for Intellectual Stack.....	5	3.6 Exiting Intellectual Stack menu	19
2.2 Installing the first projector (Set A)	6	STACK menu	19
Deciding installation position	6	Dialog from STACK menu.....	19
Setting up Set A	6	3.7 Important information for Intellectual Stack	20
2.3 Installing the second projector (Set B)	8	4. Connecting cables	23
Deciding installation position	8	4.1 Connecting an RS-232C cable ...	23
Connecting projectors	8	4.2 Connecting signal cables.....	24
Setting up Set B	8	Inputting image from Main to Sub	24
2.4 Confirming Main and Sub settings.....	10	Inputting image to Sub and Main individually.....	24
2.5 Fine adjusting image position	11	5. Setting input ports using menu	25
For Intellectual Stack users	11	5.1 Preparing for menu operations ...	25
For Simple Stack users.....	12	5.2 Checking Main projector's operating status	25
		5.3 Starting up Main projector	26
		5.4 Setting the menu	27
		Inputting image from Main to Sub - Computer signal	27
		Inputting image from Main to Sub - Video signal (either component or video)	28
		Inputting image to Sub and Main individually.....	28
		6. Restrictions on Schedule function	30
		7. Troubleshooting	32

1. Introduction

1.1 Basic information and preparations

Instant Stack

Instant Stack is a feature that allows you to superimpose images projected from two projectors easily.

Intellectual Stack and Simple Stack

Instant Stack includes the following two features.

When two projectors are connected using an RS-232C cable with necessary settings performed on the projectors, these two projectors automatically operate in synchronization with each other according to the settings. This is known as Intellectual Stack in this manual.

The two projectors operate individually without the RS-232C connection. This is known as Simple Stack in this manual.

Remote control for Intellectual Stack and Simple Stack

For Intellectual Stack, one projector is set as Main and the other is set as Sub. Only the Main projector is capable of receiving the remote control signals. Operate the projectors from the control panel of the Main projector or with the remote control pointing at the Main projector. For details on operating by remote control and from the control panel, refer to [3.7 Important Information for Intellectual Stack](#).

For Simple Stack, both projectors can receive the remote control signals. To avoid incorrect operations with the remote control, it is recommended to operate with the control panel or a wired remote control. KEYLOCK or REMOTE ID function is also available. ([📖 Operating Guide](#) → [OPTION menu](#))

If you require more information on Instant Stack, consult your dealer.

⚠️WARNING ▶ Do not place projectors directly on top of other projectors.

⚠️CAUTION ▶ Place the projector in a cool place with sufficient ventilation. Keep a space of 50 cm or more between a side of the projector and other objects such as a wall. Keep a space of 50 cm or more between the two projectors, especially if you are installing the projectors side by side. Take care not to let the hot exhaust air from other projectors enter the intake vents of the projector.

(continued on next page)

NOTICE ► Intellectual Stack can be operated only in pairs of the same model projectors.

- A maximum of two projectors can be used as Intellectual Stack.
- Use the same type of lens for both projectors.
- Depending on the installation and surrounding environment, images projected from the two projectors may not superimpose well enough. The images cannot superimpose well enough especially when the screen is slanted, deformed or the surface is uneven.
- Images projected immediately after turning on the projectors are unstable due to rising internal temperature. Wait for more than 20 minutes before starting to adjust the superimposed images.
- The image positions may shift due to temperature change, vibration, or shock caused by hitting the projector. Install the projectors in a stable environment when using Instant Stack. If the image positions are shifted, readjust the images. (📖6, 8, 11)
- The image positions may shift over time due to the tension and the weight of the connecting cables. Make sure not to impose any load on the projectors when arranging the cables.
- If the volume level of the built-in speakers is too high, noise may occur and the image quality may deteriorate. In this case, check the volume setting on both projectors.
- When two projectors are connected using the RS-232C cable, the Main projector can control the Sub projector. This feature is known as Intellectual Stack. (📖8) When Intellectual Stack by means of RS-232C feature is used, RS-232C communication cannot be used to control the projector. If you want to control the projectors from a computer, use the LAN connection that is connected to any of the projectors.
- When Intellectual Stack is used, the operations or settings of some functions are restricted. Refer to this manual for details. (📖30)

2. Installation

For safety reasons, read [1.1 Basic information and preparations](#) ([📖 3, 4](#)) carefully before installation. In addition, take note of the following for proper use of Instant Stack.

- Use the same model projectors.
- Arrange the projectors side by side.
- Make sure the projection screen is perpendicular to the projectors.
- Project images larger than the recommended screen size shown in the table. The greater the distance between the projectors, the larger the screen size needs to be.

L: distance [cm]	Recommended screen size [inch]
50	250
100	380

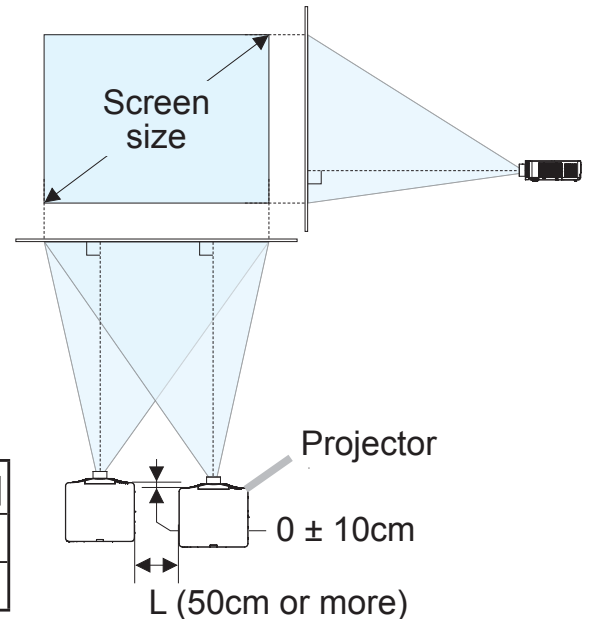

- To avoid incorrect operations with the remote control, it is recommended to operate with the control panel or a wired remote control if you control one projector with the remote control during installation. KEYLOCK or REMOTE ID function is also available. ([📖 Operating Guide](#) → [OPTION menu](#))
- Images from Set **A** and Set **B** may superimpose well but the image positions can shift over time. Readjust to superimpose the images.

2.1 Preparing for Intellectual Stack

When using Intellectual Stack via RS-232C connection, ensure the following settings are set on the two projectors. Otherwise, the Intellectual Stack menu cannot be operated.

- STANDBY MODE in SETUP menu: NORMAL ([📖 Operating Guide](#) → [SETUP menu](#))
- COMMUNICATION TYPE under COMMUNICATION in SERVICE menu: OFF ([📖 Operating Guide](#) → [OPTION menu](#))
- STACK LOCK in SECURITY menu: OFF

When STACK LOCK is set to on, menus related to Instant Stack cannot be operated. You must set it to off during installation and menu setting.

(1) Use the ▲/▼/◀/▶ buttons to go into the following menu.

ADVANCED MENU > SECURITY (> ENTER PASSWORD) > STACK LOCK

STACK LOCK dialog appears on screen. ([📖 Operating Guide](#) → [SECURITY menu](#))



(2) Use the ▲/▼ buttons to highlight OFF, and press the ▶ button to complete the setting.

2.2 Installing the first projector (Set A)

Deciding installation position

Decide on the position of Set **A** and its projection angle. ([📖 User's Manual \(concise\)](#) → *Arrangement* and *Adjusting the projector's elevator*)

⚠️ WARNING ▶ You can install the projector for any direction with specified mounting accessories. Consult with your dealer about such a special installation.

NOTE • Set the tilt angle of Set **A** to within 5 degrees from the level line.

Setting up Set **A**

1. Turn on Set **A**.
2. Run the INSTALLATION setting if necessary as it may change the image position. ([📖 Operating Guide](#) → *SETUP menu*)
3. Adjust the image of Set **A** to fit the screen with the ZOOM, FOCUS and LENS SHIFT features. ([📖 Operating Guide](#) → *Adjusting the lens*)
Adjust the image position using KEYSTONE and 3D KEYSTONE if necessary. ([📖 Operating Guide](#) → *EASY MENU* or *SETUP menu*)

NOTE • KEYSTONE, 3D KEYSTONE, and WARPING functions cannot be used at the same time. Use an appropriate function.

- If using Simple Stack, go to [2.3 Installation of the second projector \(Set B\)](#). ([📖 8](#))

(continued on next page)

4. Display the menu with the **MENU** button. ([📖 Operating Guide](#) → *Using the menu function*)

5. Use the ▲/▼/◀/▶ buttons to go into the following menu.

ADVANCED MENU > OPTION
 > SERVICE > COMMUNICATION
 > STACK

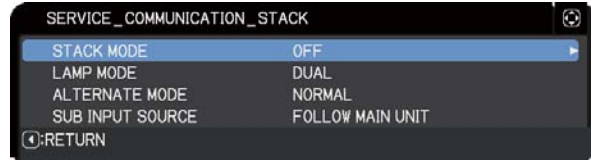

STACK menu appears on screen.
 ([📖 Operating Guide](#) → *OPTION menu*)

6. Use the ▲/▼ buttons to highlight STACK MODE, and press the ▶ button to display the STACK MODE dialog.



Highlight SUB pressing the ▲/▼ buttons, and press the ▶ button.

7. After pressing the ▶ button, a dialog to confirm whether or not to save the setting is displayed.

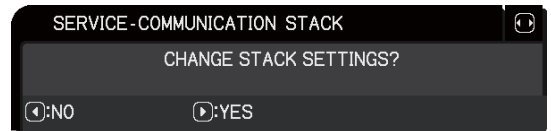

Press the ▶ button to complete the setting. ([📖 19](#))

NOTE • To avoid incorrect operations with the remote control, it is recommended to operate with the control panel or a wired remote control. KEYLOCK or REMOTE ID function is also available.

2.3 Installing the second projector (Set **B**)

Deciding on the installation position

Decide on the position of Set **B** and its projection angle. ([📖 User's Manual \(concise\)](#) → *Arrangement* and *Adjusting the projector's elevator*)

⚠️ WARNING ▶ You can install the projector for any direction with specified mounting accessories. Consult with your dealer about this installation.

NOTE • Set the tilt angle of Set **B** to within 5 degrees from the level line.

Connecting projectors

To use Intellectual Stack, connect an RS-232C cross cable between the **CONTROL** port of Set **A** and Set **B**.

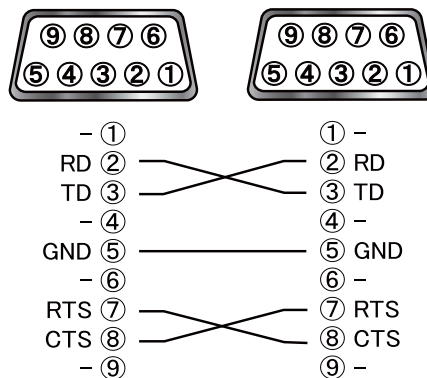

Setting up Set **B**

1. Turn on Set **B**.

NOTE • After turning on Set **B**, make sure the image of Set **B** is not significantly tilted compared to the image of Set **A**. If the image is overly tilted, rotate the elevator feet of Set **B** to adjust the angle such that the tilt is just about right.

2. Reset the adjustment of KEYSTONE and 3D KEYSTONE on Set **B**.

([📖 Operating Guide](#) → *EASY MENU* or *SETUP menu*)

NOTE • KEYSTONE, 3D KEYSTONE, and WARPING functions cannot be used at the same time. Use an appropriate function.

• Run the INSTALLATION setting first if necessary as it may change the image position. ([📖 Operating Guide](#) → *SETUP menu*)

(continued on next page)

- Adjust the image size and position of Set **B** with the ZOOM, FOCUS and LENS SHIFT features such that the image can be superimposed to the image of Set **A**. ([📖 Operating Guide](#) → [Adjusting the lens](#))

NOTE • Fine adjustment of the image size and position afterwards with functions such as KEYSTONE and 3D KEYSTONE does not increase the image size. You must have the image of Set **B** completely overlapping the image of Set **A**.

- When controlling Set **B** with the remote control, Set **A** may also respond to the remote control. To avoid incorrect operations with the remote control, it is recommended to operate with the control panel or a wired remote control. KEYLOCK or REMOTE ID function is also available.
- If using Simple Stack, go to [For Simple Stack users](#). ([📖 12](#))

- Display the menu with the **MENU** button. ([📖 Operating Guide](#) → [Using the menu function](#))

- Use the ▲/▼/◀/▶ buttons to go into the following menu.

ADVANCED MENU > OPTION
 > SERVICE > COMMUNICATION
 > STACK

STACK menu appears on screen.

([📖 Operating Guide](#) → [OPTION menu](#))

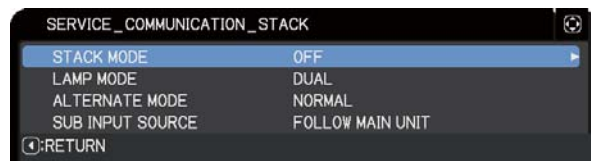

- Use the ▲/▼ buttons to highlight STACK MODE, and press the ▶ button to display the STACK MODE dialog.

Highlight MAIN with the ▲/▼ buttons, and press the ◀ button to return to the previous menu.

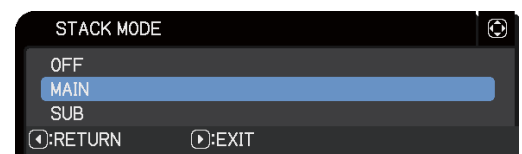

- Use the ▲/▼ buttons to highlight LAMP MODE, and press the ▶ button to display the LAMP MODE dialog.

Highlight DUAL with the ▲/▼ buttons, and press the ▶ button.



- After pressing the ▶ button, a dialog to confirm whether or not to save the setting is displayed.

Press the ▶ button to complete the setting.

([📖 19](#))

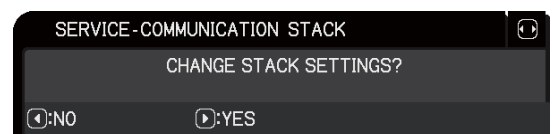

2.4 Confirming Main and Sub settings

1. Press the **MENU** button on the remote control for Main (Set **B**).

NOTE • When Intellectual Stack is in use, only Main is capable of receiving the remote control signals. Sub does not respond to the remote control signals.

2. The following dialogs appear on the lower right screen.

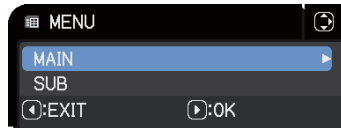

Main (Set **B**)



Sub (Set **A**)

3. If you press the ► button, the dialog closes and the Main (Set **B**) menu appears when MAIN is highlighted.
If you press the ◀ button, the dialog closes and the menu disappears.

NOTE • If these dialogs are not displayed on screen, check the RS-232C connection ([📖 8](#)) and the MAIN or SUB setting in the STACK MODE dialog. ([📖 14](#))

2.5 Fine adjusting image position

To superimpose the images of Main (Set **B**) and Sub (Set **A**), fine adjust the image size and position of Main (Set **B**) using 3D KEYSTONE.

For Intellectual Stack users

1. Press the **MENU** button on the remote control or the control panel on Main (Set **B**) to display the MENU dialog.
Highlight MAIN with the ▲/▼ buttons, and press the ► button.
Menu on Main (Set **B**) appears.
2. Using the ▲/▼/◀/▶ buttons on the remote control or the control panel on Main (Set **B**), select 3D KEYSTONE from EASY MENU, or the SETUP menu of ADVANCED MENU. ([Operating Guide](#) → [EASY MENU](#) or [SETUP menu](#))
The image for Intellectual Stack appears on screen. This image includes a TEMPLATE screen with the 3D KEYSTONE dialog from Main (Set **B**) and another TEMPLATE screen from Sub (Set **A**).
3. Using 3D KEYSTONE on Main (Set **B**), adjust the image size and position of Main (Set **B**) to superimpose to the image of Sub (Set **A**). ([Operating Guide](#) → [EASY MENU](#) or [SETUP menu](#))
Adjust 3D KEYSTONE in the following ways.
 - (1) Roughly adjust the four corners in the order below.
Top left → Top right
→ Bottom right → Bottom left
 - (2) Fine adjust the four corners in the same way.

Main (Set **B**)

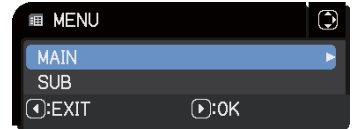

Image from Main (Set **B**)

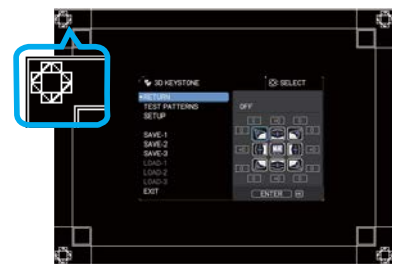
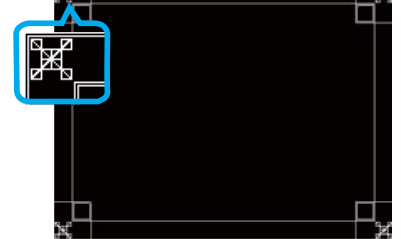
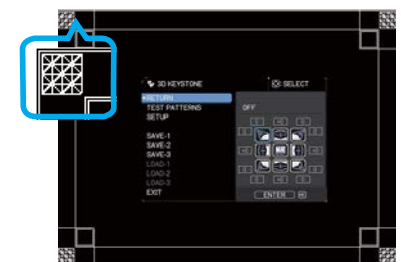

Image from Sub (Set **A**)



Superimposed image



NOTE • Refer to [NOTES for all users](#). ([12](#))

For Simple Stack users

1. Press the **MENU** button on the remote control to display the menu on Set **A**.
2. Use the ▲/▼/◀/▶ buttons to open the TEMPLATE dialog, then select STACK on the dialog.
([Operating Guide](#) → *MENU PREFERENCES*)
3. Press the **MENU** button on the control panel of Set **B** to display the menu.
4. Use the ▲/▼/◀/▶ buttons to select 3D KEYSTONE from EASY MENU, or the SETUP menu of ADVANCED MENU. ([Operating Guide](#) → *EASY MENU* or *SETUP menu*)
3D KEYSTONE dialog appears on screen.
Set TEST PATTERNS settings to ON to display the test pattern.
5. Using 3D KEYSTONE on Set **B**, adjust the image size and position of Set **B** to superimpose well to the image of Set **A**. Adjust 3D KEYSTONE in the following ways.
 - (1) Roughly adjust the four corners in the order below.
Top left → Top right → Bottom right → Bottom left
 - (2) Fine adjust the four corners in the same way.

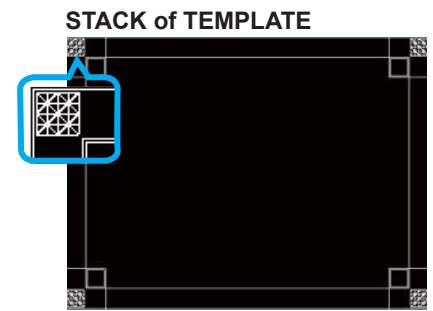

3D KEYSTONE dialog on STACK of TEMPLATE

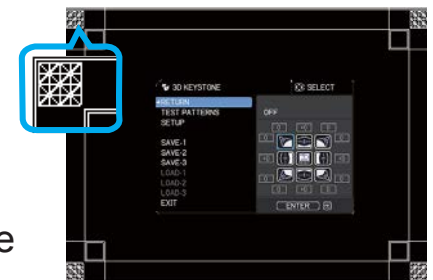

NOTES for all users • For details on 3D KEYSTONE, refer to [3D KEYSTONE](#) of [EASY MENU](#) or [SETUP menu](#) in the [Operating Guide](#).

- It is strongly recommended to use a flat screen. If a curved or skewed screen is used, it is difficult to align the two images even if you use the pin/barrel adjustment of 3D KEYSTONE.
- Even through fine adjustment of the images from the two projectors, it may not be possible to superimpose the images depending on the input signals. In this case, try the following methods.
 - Press the **AUTO** button on the remote control or execute AUTO IMAGE ([Operating Guide](#) → *SIZE AND POSITION menu*) on each of the projectors.
 - Adjust H POSITION and V POSITION ([Operating Guide](#) → *SIZE AND POSITION menu*) on each of the projectors.
 - Check the RESOLUTION setting in the INPUT menu, and change to the same setting if the setting differs between Main and Sub. ([Operating Guide](#) → *INPUT menu*)

3. STACK menu settings

Set the Intellectual Stack operation using the STACK menu.

- NOTE • If using Simple Stack without RS-232C connection, skip this chapter.
- If you do not need to change the settings made during the installation explained prior to this chapter, go to [3.3 Selecting lamp operation mode](#). (📖15)
 - Read [3.7 Important information for Intellectual Stack](#) carefully. (📖20)

3.1 Displaying STACK menu

Use the ▲/▼/◀/▶ buttons to go into the following menu.

ADVANCED MENU > OPTION
 > SERVICE > COMMUNICATION > STACK

STACK menu appears on screen.

(📖Operating Guide → OPTION menu)



The setting for Intellectual Stack operation starts from this menu.

- NOTE • Check that the following settings are made on both projectors. Otherwise, STACK menu on the projectors cannot be operated. (📖5)
- STANDBY MODE in SETUP menu: NORMAL
 (📖Operating Guide → SETUP menu)
 - COMMUNICATION TYPE under COMMUNICATION in SERVICE menu: OFF
 (📖Operating Guide → OPTION menu)
 - STACK LOCK in SECURITY menu: OFF (📖5)

3.2 Selecting Main, Sub or off

To enable Intellectual Stack, select either MAIN or SUB. Intellectual Stack starts when one projector is set to MAIN and the other is set to SUB in the STACK MODE dialog. To disable Intellectual Stack, select OFF.

1. Highlight STACK MODE in the STACK menu with the ▲/▼ buttons, then press the ► button to display the STACK MODE dialog.

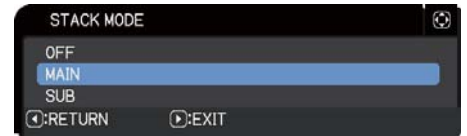

2. Use the ▲/▼ buttons in the dialog to highlight MAIN, SUB or OFF.

OFF: Disables Intellectual Stack.

MAIN: Sets the projector to Main that functions as a control tower.

SUB: Sets the projector to Sub that functions as a follower.

3. Press the ◀ button to return to the previous menu, or press the ► button to complete the setting. (📖 19)

NOTE • After setting Main or Sub, the setting information can be checked on Projector Web Control. (📖 [Network Guide](#) → [Projector Web Control](#))

Select Projector Status in the main menu of Projector Web Control. The Stack Mode item shows whether your projector is set to MAIN or SUB even if STACK MODE is set to OFF.

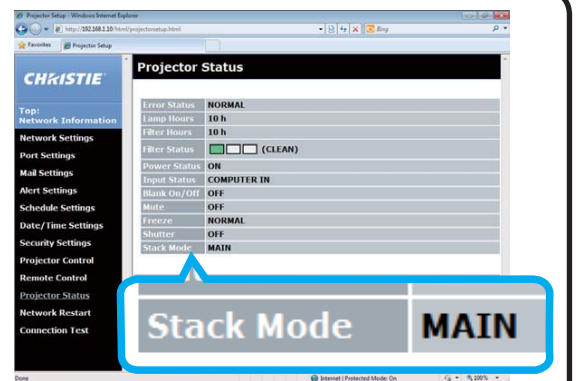

3.3 Selecting lamp operation mode

Select the DUAL or ALTERNATE lamp operation mode.

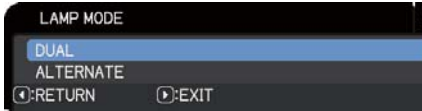
1. Highlight LAMP MODE in the STACK menu with the ▲/▼ buttons, then press the ► button to display the LAMP MODE dialog. 
2. Use the ▲/▼ buttons in the dialog to highlight DUAL or ALTERNATE.
 - DUAL:** Turns on the projectors at the same time.
 - ALTERNATE:** Turns on the projectors alternately.
3. Press the ◀ button to return to the previous menu, or press the ► button to complete the setting. (📖 19)

NOTE • If DUAL is selected, a menu to select MAIN or SUB appears on screen when a button on the control panel of the projector or remote control is pressed. Select the projector that you want to operate. Refer to the examples below.

- When the **MENU** button is pressed, a menu to select MAIN or SUB is displayed. If MAIN is selected, EASY MENU or ADVANCED MENU of the Main projector is displayed.
- When one of the buttons from **GEOMETRY**, **FOCUS + / -**, **ZOOM**, **ZOOM + / -** and **LENS SHIFT** is pressed, a menu to select MAIN or SUB is displayed. If MAIN is selected, each menu or dialog of the Main projector is displayed.
- When the **ENTER** button is pressed for three seconds, a menu to select MAIN or SUB is displayed. If MAIN is selected, the Status Monitor on the Main Projector can be operated.
- When DUAL is selected for LAMP MODE, there are operating restrictions as follows.
 - AUTO POWER OFF and FREEZE functions on both projectors are disabled.
 - It takes slightly longer time to turn on the projectors. This is not a malfunction.
 - There are cases in which the screen is darker when any of the OSDs are displayed if DUAL is selected.
 - The screen may be darker when any of the OSDs are displayed in PbyP or PIP display because one of the two projectors displays the black screen.

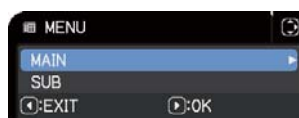

Menu to select MAIN or SUB

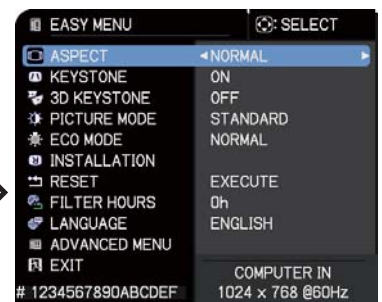

Menu on Main projector

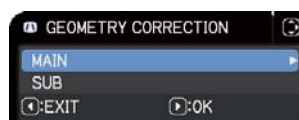

Menu to select MAIN or SUB

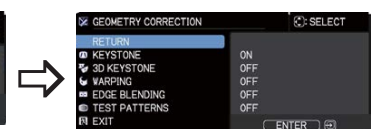

Menu on Main projector

(continued on next page)

NOTE • When DUAL is selected for LAMP MODE, the images projected from the Main and Sub projectors may be different. It is recommended to set the projectors as follows.

- Set the same image for TEMPLATE and START UP on the Main and Sub projectors.
- Capture the same image for My Screen on the Main and Sub projectors.
- Save the same image on MY IMAGE on the Main and Sub projectors.
- Set the same message content for the Messenger function ([📖 Network Guide](#) → [Messenger Function](#)) on the Main and Sub projectors.
- When DUAL is selected for LAMP MODE, image shift can result in image quality degradation on the screen. Run the INSTALLATION setting before adjusting the image position as the image position changes when the INSTALLATION setting is changed. ([📖 Operating Guide](#) → [SETUP menu](#))
- When ALTERNATE is selected and an error occurs on the projector during operation causing the lamp to turn off, the other projector automatically starts to operate. However, if the RS-232C cable is disconnected or AC power is not supplied, the other projector does not turn on.
- In cases when PIN LOCK or TRANSITION DETECTOR on both projectors is set to ON ([📖 Operating Guide](#) → [SECURITY menu](#)), the two projectors do not turn on even if ALTERNATE is selected. Enter the security code on both projectors and one of the projectors turns on.
- When Intellectual Stack is in use, the **POWER** indicator on the projector operates differently from normal. ([📖 Operating Guide](#) → [Troubleshooting](#))
When both the Main and Sub projectors are in standby mode, the Main projector determines which projector to turn on according to the STACK MODE setting if the **ON** button on the remote control or **STANDBY/ON** button of the Main projector is pressed.
 - The **POWER** indicator on the Main projector blinks in green while the Main projector determines which projector to turn on.
 - If the Main projector is turned on, the **POWER** indicator on the Main projector turns to steady green after lighting up, as per normal.
 - If the Sub projector is turned on, the **POWER** indicator on the Main projector lights in orange after the Sub projector is turned on.
 - If an error occurs on the Main projector, the Sub projector turns on and the **POWER** indicator on the Main projector lights or blinks in red.

3.4 Selecting lamp switching mode

The following setting is necessary only when ALTERNATE is selected in the LAMP MODE dialog. (📖 15) Select the AUTO or NORMAL lamp switching mode when using ALTERNATE.

1. Highlight ALTERNATE MODE in the STACK menu with the ▲/▼ buttons, then press the ► button to display the ALTERNATE MODE dialog.



2. Use the ▲/▼ buttons in the dialog to highlight AUTO or NORMAL.
 - AUTO:** Turns on the projector with the least lamp usage.
 - NORMAL:** Turns on the projector that was not used the previous time.
3. Press the ◀ button to return to the previous menu, or press the ► button to complete the setting. (📖 19)

NOTE • The ALTERNATE MODE dialog can be operated on the Main projector when ALTERNATE is selected in the LAMP MODE dialog.

- To maintain the quality and reliability of the two projectors, the projector with the most lamp usage may be turned on even if AUTO is selected.

3.5 Selecting input source for Sub

1. Highlight SUB INPUT SOURCE in the STACK menu with the ▲/▼ buttons, then press the ► button to display the SUB INPUT SOURCE dialog.



2. Use the ▲/▼ buttons in the dialog to highlight FOLLOW MAIN UNIT or FIXED (COMPUTER IN).

FOLLOW MAIN UNIT: Sets the input source on the Sub projector to the same port as Main.

FIXED (COMPUTER IN): Sets the input source on the Sub projector to the **COMPUTER IN** port which is connected to the **MONITOR OUT** port on the Main projector.

3. Press the ◀ button to return to the previous menu, or press the ► button to complete the setting. (📖 19)

NOTE • When the projectors are in the PbyP/ PIP mode, the SUB INPUT SOURCE is fixed at FOLLOW MAIN UNIT.

- If FIXED (COMPUTER IN) is selected, the **COMPUTER IN** port can be selected as an input source on the Main projector. When any button to select an input port on the remote control or the **INPUT** button on the projector is pressed, the MAIN INPUT SOURCE dialog is displayed on screen.

- If FIXED (COMPUTER IN) is selected, the **COMPUTER IN** port on the Sub projector should be connected to the **MONITOR OUT** port on the Main projector with a computer cable. The image from the selected port is output from the **MONITOR OUT** port on the Main projector to the **COMPUTER IN** port on the Sub projector.

- If FIXED (COMPUTER IN) is selected, video signals can be input to the **COMPUTER IN** port on the Main projector. Set the port for video signal input in the COMPUTER IN menu and set the video format in the VIDEO FORMAT menu. Refer to *Inputting image from Main to Sub* (📖 24) and *Inputting image from Main to Sub - Video signal (either component or video)*. (📖 28)

3.6 Exiting Intellectual Stack menu

Before exiting menu operation for Intellectual Stack, check all the settings in the STACK menu. For dialogs called from the STACK menu, press the ◀ button to return to the STACK menu.

Refer to the following to exit menu operation for Intellectual Stack.

STACK menu

When you press the ◀ button (functioning as RETURN key) after performing some changes to the settings, a confirmation dialog appears.

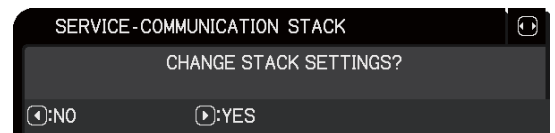

- Pressing the ▶ button (functioning as YES key) in the dialog saves the setting and closes the dialog. The screen becomes black while the setting is being applied. Wait for a while.
- Pressing the ◀ button (functioning as NO key) in the dialog returns you to the COMMUNICATION menu without saving the setting. ([📖 Operating Guide](#) → [OPTION menu](#) → [SERVICE](#))

Dialog from STACK menu

When you press the ▶ button (functioning as EXIT key) after performing some changes to the settings, a confirmation dialog appears.

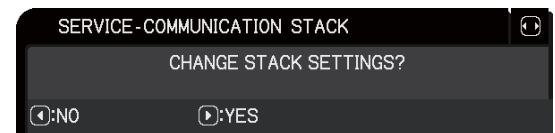

- Pressing the ▶ button (functioning as YES key) in the dialog saves the setting and closes the dialog. The screen becomes black while the setting is being applied. Wait for a while.
- Pressing the ◀ button (functioning as NO key) in the dialog closes the dialog without saving the setting.

3.7 Important information for Intellectual Stack

This section provides important information for setting up the Main and Sub projectors, read all information carefully.

- To use Intellectual Stack, one projector must be set to Main and the other set to Sub.
- All buttons except the **STANDBY/ON** button on the control panel of the Sub projector are disabled. Operate the projectors with the control panel of the Main projector or the remote control.
- Pressing the **STANDBY/ON** button of the Sub projector does not allow you to turn off only the Sub projector. The Main and Sub projectors turn off when the button is pressed for more than three seconds. Pressing the button does not turn on the Main or Sub projector.
- The Main projector is capable of receiving the remote control signals but not the Sub projector so the remote control should be pointed at the Main projector.
- Each Status Monitor can be operated individually from the respective control panel of the Main and Sub projectors. Only the monitor on the projector that has been turned on can be operated with the remote control.
- If a wired remote control is used, connect the cable to the Main projector instead of the Sub projector.
- AUTO SEARCH function is disabled when the projector is used in Intellectual Stack.
- Network communication to Sub and Web Control on Sub cannot turn on the Sub projector. The Sub projector can only be controlled through the Main projector.
- The Web Remote Control function of the Sub projector is disabled. ( [Network Guide](#) → [3.1.11 Remote Control](#))
- If you try to turn on the projectors using the Power on & Display on feature on the Messenger function, the projectors exit Intellectual Stack and display the specified message. To start Intellectual Stack again, re-select MAIN/SUB on both projectors in the STACK MODE dialog, or turn off and on both projectors again.

(continued on next page)

3.7 Important information for Intellectual Stack (continued)

- The Main and Sub projectors have the following common settings.
 - AV MUTE ([📖 Operating Guide](#) → *Temporarily turning off the screen and audio*)
 - Magnifying feature ([📖 Operating Guide](#) → *Using the magnify feature*)
 - ASPECT and OVER SCAN ([📖 Operating Guide](#) → *SIZE AND POSITION menu*)
 - COMPUTER IN ([📖 Operating Guide](#) → *INPUT menu*)
 - OSD MESSAGE ([📖 Operating Guide](#) → *SETUP menu*)
 - MY BUTTON ([📖 Operating Guide](#) → *OPTION menu*)
 - TEMPLATE ([📖 Operating Guide](#) → *MENU PREFERENCES*)
 - SHUTTER ([📖 Operating Guide](#) → *Temporarily shading the screen*)
 - SHUTTER TIMER ([📖 Operating Guide](#) → *OPTION menu*)
 - PbyP/PIP ([📖 Operating Guide](#) → *PbyP/PIP*)
- The following functions are disabled.
 - STANDBY MODE ([📖 Operating Guide](#) → *SETUP menu*)
 - AUTO SEARCH ([📖 Operating Guide](#) → *OPTION menu*)
 - DIRECT POWER ON ([📖 Operating Guide](#) → *OPTION menu*)
 - AUTO POWER OFF ([📖 Operating Guide](#) → *OPTION menu*)
 - COMMUNICATION TYPE ([📖 Operating Guide](#) → *OPTION menu* → *SERVICE* → *COMMUNICATION*)
 - SOURCE SKIP ([📖 Operating Guide](#) → *OPTION menu*)
- **LAN** port cannot be selected.
- When the projectors are in the PbyP/PIP mode, the SUB INPUT SOURCE is fixed at FOLLOW MAIN UNIT.
- When Intellectual Stack is in use, an error message is displayed if an error occurs on any of the projectors.

When an error occurs, a full dialog is displayed on screen. The full dialog changes to a small dialog after about 20 seconds without any key activity. While the small dialog is displayed, pressing the ◀ button displays a full dialog again.

The numbers “1” and “2” above the projector icons represent the Main and Sub projectors respectively.

Refer to the on-screen messages as shown below and take the necessary actions to resolve the problem.



Full dialog



Small dialog

(continued on next page)

Example:

Cover Error: Lamp cover is opened.

Lamp Error: Lamp does not light up.

Fan Error: Problem with cooling fan.

Temp Error: Temperature of the projector is too high.

Air Flow Error: Temperature of the projector is too high, check that the exhaust vents are not blocked.

Filter Error: The reading on the filter timer exceeds the hours set in the FILTER MESSAGE menu. ([Operating Guide](#) → [OPTION menu](#) → [SERVICE](#))

Cold Error: The ambient temperature is too low.

Shutter Error: Shutter does not work.

Lens Shift Error: Lens Shift does not work.

AC Blackout Error: Power supply was interrupted momentarily.

Other Error: Errors except the above.

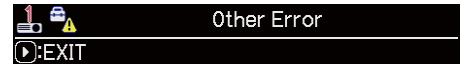

- If you need to turn off a projector for reasons such as taking corrective actions for an error, turn off both the projectors so that Intellectual Stack can be started properly when the projectors are turned on again.
- If the PIN LOCK or TRANSITION DETECTOR security function on both projectors is set to ON, both projectors turn on. Enter the security code for Main first then followed by Sub. If ALTERNATE mode is selected, one of the projectors turns off automatically. ([Operating Guide](#) → [SECURITY menu](#))
- If the PIN LOCK or TRANSITION DETECTOR security function on one of the projectors is set to ON, you must enter the security code as follows when turning on the projector.
 - In DUAL mode, both projectors turn on. Enter the security code for the projector that is locked by the security function.
 - In ALTERNATE mode, if the projector is locked by the security function is due to turn on according to the ALTERNATE mode setting, only that projector turns on. Otherwise, both projectors turn on. Enter the security code for the projector that is locked by the security function. After the security lock is released, one of the projectors turns off if both projectors are turned on.

4. Connecting cables

To superimpose two images onto one screen, the same image must be input to the Main and Sub projectors. There are various methods to input the image to the projectors. This chapter describes the ways of connecting the cables. Read this chapter to find a method that meets your needs.

NOTE • If Simple Stack without an RS-232C connection is used, the Main and Sub projectors described below do not exist. Main in this chapter is read as one projector and Sub as the other projector.

• For details on the specifications of the input ports, refer to [Connecting with your devices](#) ([📖 Operating Guide](#) → [Setting up](#)) and [Connection to the ports.](#) ([📖 Operating Guide - Technical](#))

4.1 Connecting an RS-232C cable

If using Intellectual Stack, connect an RS-232C cross cable between the **CONTROL** ports on the Main and Sub projectors. ([📖 8](#)) This connection is not required if using Simple Stack.

NOTE • If the RS-232C cable connecting the two projectors operating in Intellectual Stack is disconnected, the projectors exit from Intellectual Stack and start to operate individually. Intellectual Stack does not restart even if the cable is reconnected. Follow the procedures below to restart Intellectual Stack.

- (1) Do not operate the projectors for more than 10 seconds after disconnecting the cable to allow the projectors to recognize the disconnection of the cable.
- (2) Turn off both projectors and allow them to cool sufficiently.
- (3) Reconnect the two projectors with the RS-232C cable and turn them on again. Intellectual Stack restarts.

4.2 Connecting signal cables

There are two methods to input an image to the Sub projector. (18, 19)

- Inputting an image from the **MONITOR OUT** port on Main to Sub.
- Inputting an image to Sub and Main individually.

LWU601i/LW651i/LW751i/LX801i

Inputting image from Main to Sub

1. Connect the **MONITOR OUT** port on Main to the **COMPUTER IN** port on Sub with a computer cable.
2. Connect the image output device to one of the input ports on Main.

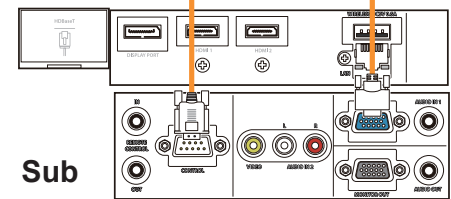
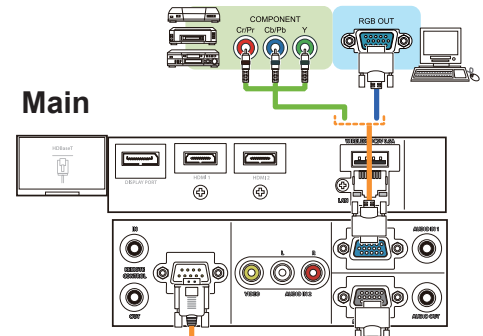

LWU701i

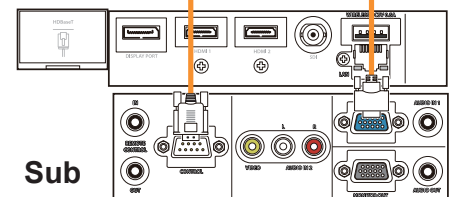
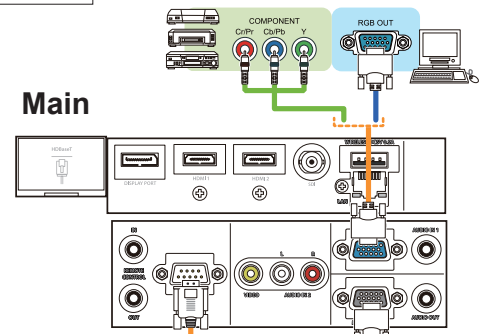

Connection example in Intellectual Stack

Inputting image to Sub and Main individually

1. Split the output signal from your image device into two with device such as a signal splitter.
2. Connect the output ports of the image output device to the same input ports on the Main and Sub projectors.

NOTES for Intellectual Stack • **LAN** cannot be used as the input port on the Main projector in Intellectual Stack.

NOTES for Simple Stack • Any ports compatible with the signal can be used. Input the same signal to the two projectors individually.

5. Setting input ports using menu

5.1 Preparing for menu operations

If Simple Stack without an RS-232C connection is used, press the button corresponding to the port on the remote control or the **INPUT** button on the projector to select the port to which the cable is connected.

This completes the setting.

If Intellectual Stack with the RS-232C connection is used, all settings or modifications related to Intellectual Stack menu operations must be performed on the Main projector. The Main projector functions according to the input settings for Intellectual Stack.

5.2 Checking the Main projector's operating status

For Intellectual Stack, all settings or modifications related to menu operations must be performed on the Main projector. Before operating the menu for Intellectual Stack, check if the Main projector is functioning.

1. Press the **MENU** button on the remote control.
2. If the MENU dialog as shown on the right appears on the screen, the two projectors are operating in DUAL mode and the Main projector is operating.

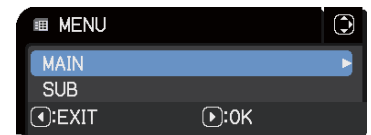

Go to [5.4 Setting the menu](#). (📖27)

If the dialog does not appear, LAMP MODE is set to ALTERNATE and either the Main or Sub projector is operating. Go to next.

3. Use the ▲/▼/◀/▶ buttons to go into the following menu.

ADVANCED MENU > OPTION
 > SERVICE > COMMUNICATION
 > STACK

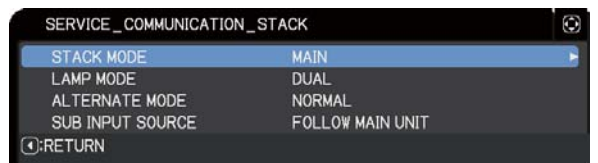

STACK menu appears on screen.

(📖Operating Guide → OPTION menu)

4. Check the STACK MODE setting in the STACK menu.
 - If MAIN is displayed, the Main projector is operating. Go to [5.4 Setting the menu](#). (📖27)
 - If SUB is displayed, the Main projector is turned off and the Sub projector is operating. Go to [5.3 Starting up Main projector](#). (📖26)

5.3 Starting up the Main projector

After performing section [5.2 Checking Main projector's operating status](#), the two projectors are confirmed to have been set to ALTERNATE mode and the Sub projector is currently operating. As the settings for Intellectual Stack can be changed only when the Main projector is operating, this section explains how to switch from the Sub projector to the Main projector.

1. Use the ▲/▼/◀/▶ buttons to go into the following menu.

ADVANCED MENU > OPTION
> SERVICE > COMMUNICATION > STACK

STACK menu appears on screen.

([📖 Operating Guide](#) → [OPTION menu](#))



2. Check the ALTERNATE MODE setting in the menu.

If NORMAL is displayed, the two projectors are turned on alternately. Therefore, the Main projector is turned on if you restart the projectors.

- (1) Press the **STANDBY** button on the remote control or **STANDBY/ON** button of the Main projector. The Sub projector turns off.
- (2) After the projector has cooled down, press the **ON** or **STANDBY/ON** button to turn on again. The Main projector is turned on.

If AUTO is displayed, the projector with the least lamp usage is turned on. Therefore, the Main projector may not be turned on even if you restart the projectors. Follow the procedures below to turn on the Main projector.

- (1) Use the ▲/▼ button to highlight STACK MODE, and press the ▶ button to display the STACK MODE dialog.
- (2) Use the ▲/▼ button to highlight OFF, and then press the ▶ button to complete the setting. ([📖 19](#))
- (3) Repeat the above procedures to display the STACK MODE dialog again.
- (4) Use the ▲/▼ button to highlight SUB, and then press the ▶ button to complete the setting. ([📖 19](#))
- (5) After exiting the menu, wait for 10 seconds or more.
- (6) Press the **STANDBY** button on the remote control or **STANDBY/ON** button of the Main projector. The Sub projector turns off.
- (7) After the projector has cooled down, press the **ON** or **STANDBY/ON** button to turn on again. The Main projector is turned on even if LAMP MODE has been set to AUTO.

3. You can change the settings for Intellectual Stack now that the Main projector is operating. Go to [5.4 Setting the menu](#). ([📖 27](#))

NOTE • If the Main projector cannot be turned on due to an error, the Sub projector is turned on even if you follow the procedures above. Take necessary actions to fix the Main projector, and then change the settings for Intellectual Stack.

5.4 Setting the menu

If Intellectual Stack with RS-232C connection is used, observe the following. When inputting image signals to Sub using Main, the operations differ between using computer signals and video signals such as component and video signals.

Inputting image from Main to Sub - Computer signal

1. If the STACK menu is already displayed on the screen, proceed to step 3 below. Otherwise press the **MENU** button on the remote control.

If the MENU dialog is displayed, use the ▲/▼ buttons to highlight MAIN, and press the ► button. A menu is displayed.

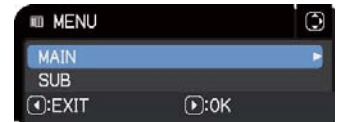

If the MENU dialog is not displayed, the STACK menu appears.

2. Use the ▲/▼/◀/▶ buttons to go into the following menu.

ADVANCED MENU > OPTION
> SERVICE > COMMUNICATION > STACK

STACK menu appears on screen.

([Operating Guide](#) → [OPTION menu](#))

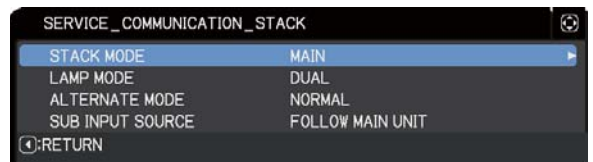

3. Use the ▲/▼ buttons to highlight SUB INPUT SOURCE, and press the ► button to display the SUB INPUT SOURCE dialog.



4. Use the ▲/▼ buttons to highlight FIXED (COMPUTER IN), and press the ► button to complete the setting. ([19](#))

5. Press any button to select an input port on the remote control or the **INPUT** button of the Main projector. The MAIN INPUT SOURCE dialog is displayed on screen. Use the ▲/▼ buttons to highlight the port to which the signal cable is connected, and press the ► button to complete the setting.

LWU601i/LW651i/LW751i/LX801i



LWU701i



NOTE • When FIXED (COMPUTER IN) is selected, input sources other than **COMPUTER IN** cannot be selected.
• When FIXED (COMPUTER IN) is selected, if any button to select an input port on the remote control or the **INPUT** button on the Main projector is pressed, the dialog for selecting the input source is displayed.

Inputting an image from Main to Sub - Video signal (either component or video)

1. If the STACK menu is already displayed on the screen, proceed to step 3 below. Otherwise press the **MENU** button on the remote control. If the MENU dialog is displayed, use the ▲/▼ buttons to highlight MAIN, and press the ► button. A menu is displayed. If the MENU dialog is not displayed, the STACK menu appears.

2. Press the **MENU** button on the remote control or control panel on the Main projector. Use the ▲/▼/◀/▶ buttons to open the COMPUTER IN dialog. ([Operating Guide](#) → [INPUT menu](#))

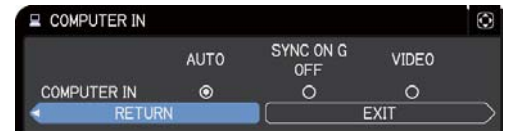

3. To input component signals to **COMPUTER IN**, set the port to AUTO. Then, use the ▲/▼/◀/▶ buttons to highlight EXIT and press the ► button to complete the setting.
To input video signals to **COMPUTER IN**, set the port to VIDEO. If it is necessary to select a video format, use the ▲/▼/◀/▶ buttons to highlight RETURN and press the ◀ button to display the INPUT menu. Otherwise, use the ▲/▼/◀/▶ buttons to highlight EXIT and press the ► button to complete the setting.

4. Select VIDEO FORMAT in the INPUT menu to display the VIDEO FORMAT dialog.



Select AUTO or an appropriate format for the video signal input.

Then, use the ▲/▼/◀/▶ buttons to highlight EXIT and press the ► button to complete the setting.

Inputting an image to Sub and Main individually

1. If the STACK menu is already displayed on the screen, proceed to step 3 below. Otherwise press the **MENU** button on the remote control. If the MENU dialog is displayed, use the ▲/▼ buttons to highlight MAIN, and press the ► button. A menu is displayed. If the MENU dialog is not displayed, the STACK menu appears.

2. Use the ▲/▼/◀/▶ buttons to go into the following menu.

ADVANCED MENU > OPTION
> SERVICE > COMMUNICATION > STACK

STACK menu appears on screen.

([Operating Guide](#) → [OPTION menu](#))

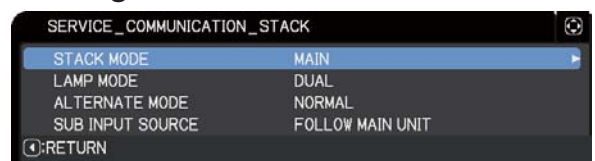

(continued on next page)

5.4 Setting the menu - Inputting image to Sub and Main individually (continued)

3. Use the ▲/▼ buttons to highlight SUB INPUT SOURCE, and press the ► button to display the SUB INPUT SOURCE dialog.

4. Use the ▲/▼ buttons to highlight FOLLOW MAIN UNIT, and press the ► button to complete the setting. (📖19)



5. Press any button to select an input port on the remote control or the **INPUT** button of the Main projector. The MAIN INPUT SOURCE dialog is displayed on screen. Use the ▲/▼ buttons to highlight the port to which the signal cable is connected, and press the ► button to complete the setting.

LWU601i/LW651i/LW751i/LX801i



LWU701i



NOTE • If FOLLOW MAIN UNIT is selected, selecting the input source on either the Main or Sub projector automatically sets the other projector to the same source.

- If FOLLOW MAIN UNIT is selected, **LAN** cannot be selected.
- When FOLLOW MAIN UNIT is selected, if any button to select an input port on the remote control or the **INPUT** button on the Main projector is pressed, the dialog for selecting the input source is displayed.

6. Restrictions on Schedule function

This model supports the Schedule function on the Projector Web Control feature. ([Network Guide](#) → [3.1.7 Schedule Settings](#)) There are some restrictions on the functions when Intellectual Stack with RS-232C connection is used. But for Simple Stack without an RS-232C connection, there is no restriction on the functions. Regardless of whether Intellectual Stack or Simple Stack is used, take note of the Schedule settings before using the Stack function. Unexpected setting changes may occur when using the Stack function. Refer to the following for the restrictions concerning Intellectual Stack. If using Simple Stack, skip this chapter.

Restrictions on the Main projector

Functions			LAMP MODE			
			DUAL	ALTERNATE		DUAL/ ALTERNATE
	Power status	Main	ON	ON	OFF	OFF
Sub		ON	OFF	ON	OFF	
Power On			✓	✓	✓	✓
Power Off			✓	✓	✓	✓
Input port change			✓ *1)	✓ *1)	✓ *1)	✓ *1)
My Image			✓	✓	X *2)	X *2)
Messenger			✓	✓	X *2)	X *2)
Blank			✓	✓	X *3)	X *3)
Eco Mode			✓	✓	✓	✓

Restrictions on the Sub projector

Functions			LAMP MODE			
			DUAL	ALTERNATE		DUAL/ ALTERNATE
	Power status	Main	ON	ON	OFF	OFF
Sub		ON	OFF	ON	OFF	
Power On			X *3	X *3	X *3	X *3
Power Off			✓	✓	✓	✓
Input port change			✓ *1)	✓ *1)	✓ *1)	✓ *1)
My Image			✓	X *2)	✓	X *2)
Messenger			✓	X *2)	✓	X *2)
Blank			✓	X *3)	✓	X *3)
Eco Mode			✓	✓	✓	✓

✓ : This Schedule can be input to Projector Web Control and be executed even if the projectors are operating in Intellectual Stack.

(continued on next page)

6. Restrictions on Schedule function (continued)

✓ *1): This Schedule can be input to Projector Web Control even if the projectors are operating in Intellectual Stack. If the input port to be changed according to the Schedule function can be used in Intellectual Stack, the Schedule is executed. If not, it is not executed.

X *2): This Schedule can be input to Projector Web Control when the projectors are operating in Intellectual Stack but it is not executed.

X *3): This Schedule can neither be input to Projector Web Control nor be executed when the projectors are operating in Intellectual Stack.







NOTE • If the Schedule is not executed, an error message is sent in accordance with the conditions set in Schedule Execution Error on Projector Web Control. ([📖 Network Guide](#) → [3.1.6 Alert Settings](#))

- If the Schedule function is set to turn off the power when the projectors are operating in Intellectual Stack, both the Main and Sub projectors are turned off.
- If the Schedule function on the Main projector is set to turn on the power, the projectors are turned on according to the LAMP MODE setting.
- When the two projectors are operating in the DUAL mode and a menu is being displayed on one of the projectors, the Schedule function for My Image and Messenger on the other projector is not executed.
- Power Off in the table refers to turning off the power and entering the standby mode according to the Intellectual Stack settings or by pressing the **STANDBY** button on the remote control or **STANDBY/ON** button of the Main projector.
- The projectors cannot be turned on by the Schedule function on the Sub projector. Set it on the Main projector if necessary.
- When the Sub projector is turned off according to the ALTERNATE MODE setting, the Schedule function on the Sub projector to turn off its power is executed without error.





7. Troubleshooting

For issues with Intellectual and Simple Stack, consult the table below.

Issues that may be mistaken for machine defects

Issues	Cases not involving a machine defect	Reference page
Intellectual Stack does not work.	<p>No power is supplied to the Main and Sub projector.</p> <p>To use the Intellectual Stack feature, supply AC power to both the Main and Sub projectors. If AC power is supplied to only one of the projectors, Intellectual Stack is disabled.</p>	<p> User's Manual (concise) → Connecting power supply</p>
	<p>The RS-232C cable between the Main and Sub projectors is not properly connected.</p> <p>To use the Intellectual Stack feature, connect an RS-232C cross cable between the Main and Sub projectors. If the cable is not connected, the Main projector cannot control the Sub projector.</p>	<p> 8</p>
	<p>The menu settings for Intellectual Stack are not performed correctly.</p> <p>Check the settings of the STACK menu on the Main and Sub projectors. To use the Intellectual Stack feature, one projector must be set to Main and the other projector must be set to Sub.</p>	<p> 14</p>
	<p>Signal cables are not connected correctly.</p> <p>Check the connection of cables. Also check that the cable connection matches with the port settings in the menu.</p>	<p> 24  Operating Guide → Connecting with your devices</p>
The Main and Sub projector do not operate in synchronization.	<p>The RS-232C cable between the Main and Sub projectors is not properly connected.</p> <p>Connect the RS-232C cable properly and restart the Main projector.</p>	<p> 8</p>

(continued on next page)

Issues	Cases not involving a machine defect	Reference page
The STACK menu does not work.	<p>The settings on the projectors are not set for the Intellectual Stack feature.</p> <p>Check the following settings on the Main and Sub projectors.</p> <ul style="list-style-type: none"> - STANDBY MODE in SETUP menu: NORMAL - COMMUNICATION TYPE under COMMUNICATION in SERVICE menu: OFF - STACK LOCK in SECURITY menu: OFF 	<p> 5</p>
The projector does not respond to the remote control.	<p>The remote control is pointed at the Sub projector.</p> <p>When operating in Intellectual Stack, only the Main projector is capable of receiving the remote control signals. Therefore, point at the Main projector when using the remote control.</p>	<p> 3</p>
The images are either out of focus or not well-superimposed.	<p>The two images are not superimposed correctly.</p> <p>Adjust to superimpose the images with the ZOOM, FOCUS and LENS SHIFT features. If necessary, adjust 3D KEYSTONE and KEYSTONE as well.</p>	<p> 6</p> <p> 11</p>
The images from the two projectors do not superimposed even after performing fine adjustment.	<p>There are some adjustment differences in the two images.</p> <p>Try to resolve the problem with the following measures.</p> <ul style="list-style-type: none"> - Press the AUTO button on the remote control or execute AUTO IMAGE on each of the projectors. - Adjust H POSITION and V POSITION on each of the projectors. - Check the RESOLUTION setting in the INPUT menu, and change to the same setting if the setting differs between Main and Sub. 	<p></p> <p><i>Operating Guide</i> → <i>Using the automatic adjustment feature</i> → <i>SIZE AND POSITION menu</i> → <i>AUTO IMAGE, H POSITION or V POSITION</i> → <i>INPUT menu</i> → <i>RESOLUTION</i></p>

If you require more information on Instant Stack, consult your dealer.

Corporate offices

USA – Cypress
ph: 714-236-8610

Canada – Kitchener
ph: 519-744-8005

Consultant offices

Italy
ph: +39 (0) 2 9902 1161

Worldwide offices

Australia
ph: +61 (0) 7 3624 4888

Brazil
ph: +55 (11) 2548 4753

China (Beijing)
ph: +86 10 6561 0240

China (Shanghai)
ph: +86 21 6278 7708

Eastern Europe and
Russian Federation
ph: +36 (0) 1 47 48 100

France
ph: +33 (0) 1 41 21 44 04

Germany
ph: +49 2161 664540

India
ph: +91 (080) 6708 9999

Japan
ph: 81-3-3599-7481

Korea (Seoul)
ph: +82 2 702 1601

Republic of South Africa
ph: +27 (0)11 510 0094

Singapore
ph: +65 6877-8737

Spain
ph: + 34 91 633 9990

United Arab Emirates
ph: +971 4 3206688

United Kingdom
ph: +44 118 977 8000



For the most current technical documentation,
please visit www.christiedigital.com

CHRISTIE®