

USER MANUAL

020-000648-02

G Series

DWX600-G/DHD600-G/DWU600-G



CHRISTIE®

The CD included with this printed manual contains an electronic copy in English. Please read all instructions before using or servicing this product.

手册中包含的光盘，带有着中文的电子副本，使用或维修本产品前，请仔细查阅所有的指示。

Le DC fourni avec ce manuel imprimé contient une copie électronique en français. S'il vous plaît lire toutes les instructions avant d'utiliser ou de réparer ce produit.

Die mit dieser gedruckten Anleitung gelieferte CD enthält eine elektronische Kopie in Deutsch. Bitte lesen Sie alle Anweisungen, bevor Sie dieses Produkt verwenden oder warten.

Il CD fornito con il manuale stampato contiene una copia elettronica in lingua italiano. Si prega di leggere tutte le istruzioni prima di utilizzare o riparare questo prodotto.

この印刷されたマニュアルに同梱されております CD には、日本語での説明書が入っております。この製品を使用あるいは修理点検される際に、ご参照下さい。

매뉴얼과 함께 포함되어 있는 CD 에는 한글로 된 전자사본을 포함하고 있습니다. 본 제품을 사용 혹은 서비스하기 전에 모든 지침 사항들을 읽어 보시기 바랍니다.

Поставляемый в комплекте с документацией компакт-диск (CD) содержит электронную копию руководства пользователя на русском языке. Перед началом использования изделия или проведения сервиса пожалуйста прочтите все инструкции изложенные в руководстве.

El DC incluido con este manual impreso contiene una copia electrónica en español. Por favor, lea todas las instrucciones antes de usar o dar servicio a este producto.

NOTICES

COPYRIGHT AND TRADEMARKS

Copyright © 2015 Christie Digital Systems USA, Inc. All rights reserved.

All brand names and product names are trademarks, registered trademarks or trade names of their respective holders.

REGULATORY

The product has been tested and found to comply with the limits for a Class A digital device, pursuant to Part 15 of the FCC Rules. These limits are designed to provide reasonable protection against harmful interference when the product is operated in a commercial environment. The product generates, uses, and can radiate radio frequency energy and, if not installed and used in accordance with the instruction manual, may cause harmful interference to radio communications. Operation of the product in a residential area is likely to cause harmful interference in which case the user will be required to correct the interference at the user's own expense.

WARNING! Changes or modifications not expressly approved by Christie could void the user's authority to operate the product.

FOR COMMERCIAL USE ONLY - POUR USAGE COMMERCIAL UNIQUEMENT

THIS DEVICE COMPLIES WITH PART 15 OF THE FCC RULES. OPERATION IS SUBJECT TO THE FOLLOWING 2 CONDITIONS: (1) THIS DEVICE MAY NOT CAUSE HARMFUL INTERFERENCE (2) THIS DEVICE MUST ACCEPT ANY INTERFERENCE RECEIVED, INCLUDING ANY INTERFERENCE THAT MAY CAUSE UNDESIRE OPERATION.

THIS CLASS A DIGITAL APPARATUS MEETS ALL REQUIREMENTS OF THE CANADIAN INTERFERENCE-CAUSING EQUIPMENT REGULATIONS.

CET APPAREIL NUMÉRIQUE DE CLASSE A EST CONFORME AUX NORMES DÉFINIES DANS LES RÉGLEMENTATIONS CANADIENNES SUR LES APPAREILS CAUSANT DES INTERFÉRENCES RADIO (CANADIAN INTERFERENCE-CAUSING EQUIPMENT REGULATIONS, ICES-003, CLASS A).

声明 此为 A 级产品，在生活环境中，该产品可能会造成无线干扰。在这种情况下，可能需要用户对其干扰采取切实可行的措施。

이 기기는 업무용 (A급)으로 전자파적합등록을 한 기기이오니 판매자 또는 사용자는 이점을 주의하시기 바라며, 가정 외의 지역에서 사용하는 것을 목적으로 합니다.

GENERAL

Every effort has been made to ensure accuracy, however in some cases changes in the products or availability could occur which may not be reflected in this document. Christie reserves the right to make changes to specifications at any time without notice. Performance specifications are typical, but may vary depending on conditions beyond Christie's control such as maintenance of the product in proper working conditions. Performance specifications are based on information available at the time of printing. Christie makes no warranty of any kind with regard to this material, including, but not limited to, implied warranties of fitness for a particular purpose. Christie will not be liable for errors contained herein or for incidental or consequential damages in connection with the performance or use of this material.

The product is designed and manufactured with high-quality materials and components that can be recycled and reused. This symbol  means that electrical and electronic equipment, at their end-of-life, should be disposed of separately from regular waste. Please dispose of the product appropriately and according to local regulations. In the European Union, there are separate collection systems for used electrical and electronic products. Please help us to conserve the environment we live in!

Canadian manufacturing facility is ISO 9001 and 14001 certified.

GENERAL WARRANTY STATEMENTS

For complete information about Christie's limited warranty, please contact your Christie dealer. In addition to the other limitations that may be specified in Christie's limited warranty, the warranty does not cover:

- a. Damage occurring during shipment, in either direction.
- b. Projector lamps (See Christie's separate lamp program policy).
- c. Damage caused by use of a projector lamp beyond the recommended lamp life, or use of a lamp supplied by a supplier other than Christie.
- d. Problems caused by combination of the product with non-Christie equipment, such as distribution systems, cameras, video tape recorders, etc., or use of the product with any non-Christie interface device.
- e. Damage caused by misuse, improper power source, accident, fire, flood, lightning, earthquake or other natural disaster.
- f. Damage caused by improper installation/alignment, or by product modification, if by other than a Christie authorized repair service provider.
- g. For LCD projectors, the warranty period specified applies only where the LCD projector is in "normal use." "Normal use" means the LCD projector is not used more than 8 hours a day, 5 days a week. For any LCD projector where "normal use" is exceeded, warranty coverage under this warranty terminates after 6000 hours of operation.
- h. Failure due to normal wear and tear.

PREVENTATIVE MAINTENANCE

Preventative maintenance is an important part of the continued and proper operation of your product. Please see the Maintenance section for specific maintenance items as they relate to your product. Failure to perform maintenance as required, and in accordance with the maintenance schedule specified by Christie, will void the warranty.

1. SAFETY	
2. INTRODUCTION	
2.1 Projector Components	2-1
2.2 Built-in Keypad	2-4
2.3 Input/Output (I/O) Panel	2-5
2.4 Remote Control	2-6
2.5 LED Status Indicators	2-8
3. INSTALLATION	
3.1 Connect to Computer	3-1
3.2 Connect to Video Equipment	3-2
3.3 Turn the Projector On	3-3
3.4 Turn the Projector Off	3-3
3.5 Adjust the Projector Position	3-4
3.6 Calculate Lens Offset	3-5
3.7 Removing and Installing the Lens	3-11
3.8 Cable Cover Installation	3-12
4. OPERATION	
4.1 Size and Position Menu	4-2
4.2 Image Settings Menu	4-7
4.3 Configuration Menu	4-10
4.4 Lamp Menu	4-15
4.5 Status Menu	4-16
4.6 Input Switching & PIP Menu	4-19
4.7 Language Menu	4-21
4.8 Test Pattern Menu	4-21
4.9 Web User Interface	4-22
4.9.1 Logging On	4-22
4.9.2 Main Tabbed Page – General	4-22
4.9.3 Main Tabbed Page – Status	4-23
4.9.4 Main Tabbed Page – Lens	4-24
4.9.5 Network	4-24
4.9.6 Tools	4-27
4.9.8 About Page	4-28
4.10 Christie Presenter	4-29
4.10.1 Connect to the Projector	4-29
4.10.2 Install Christie Presenter software	4-30
4.10.3 Use Christie Presenter	4-31
4.11 Card Reader Operation	4-37
4.12 Install the Lamp	4-41
5. TROUBLESHOOTING	
6. SPECIFICATIONS	
6.1 Inputs	6-1
6.2 PIP/PBP Compatibility	6-6
6.3 Key Features	6-7
6.4 List of Components	6-8
6.5 Optional Accessories	6-8
6.6 REGULATORY	6-9

6.7	Federal Communications Commission (FCC) Warning.....	6-10
6.8	OSD Tree	6-11
6.9	Preset Mode tables.....	6-19

1. SAFETY

Read through this document in its entirety and understand all warnings and precautions before attempting to operate the projector.

⚠ WARNING

- Do not look into the projector lens when the lamp is on. The bright light may result in permanent eye damage.
- To reduce the risk of fire or electric shock, do not expose this projector to rain or moisture.
- Do not open or disassemble the projector as this may cause electric shock.
- When replacing the lamp, allow the projector to cool, and follow all replacement instructions.
- When you turn the projector off, wait 180 seconds for the projector to cool down before you disconnect the projector from power.
- Cooling the lamp during the ignition phase may lead to ignition failures. After a successful lamp ignition, keep the lamp burning for at least 5 minutes to maintain lamp life.
- When the lamp is approaching the end of its life, the message “Lamp is approaching the end of its useful life in full power operation” appears on the screen. Change the lamp when the warning message appears.
- All installation and maintenance procedures must be performed by a Christie accredited service technician.
- Keep all combustible material away from the concentrated light beam of the projector.
- Position all cables where they cannot contact hot surfaces or be pulled or tripped over.

- Always power down the projector and disconnect all power sources before servicing or cleaning.
- Use a soft cloth moistened with a mild detergent to clean the display housing.
- Disconnect the power plug from the AC outlet if the product is not being used for an extended period of time.
- Operate the projector under the following conditions:
 - Operating temperature range: 5°C to 35°C
 - Storage temperature range: -10°C to 60°C
 - Humidity range: 5% to 80 % RH (Max.), non condensing
 - Operating altitude: 10,000 ft. maximum
- Use only the AC power cord supplied. Do not attempt operation if the AC supply and cord are not within the specified voltage and power range for your region.
- Remove the lens plug from the lens opening in the projector before installing the lens. Retain the lens plug to protect the optical components from dust and debris during transport.
- Do not block the ventilation slots and openings on the projector.
- Do not use abrasive cleaners, waxes or solvents to clean the projector.
- Do not allow anything to rest on the power cord.

2. INTRODUCTION

The product specified in this document is a high brightness, high-resolution video/graphics 1-chip mercury lamp based projector. The projector is available in WXGA, HD and WUXGA resolutions. The projector utilizes Digital Light Processing (DLP®) technology from Texas Instruments. It is primarily designed for fixed installation markets.

2.1 Projector Components

Front View

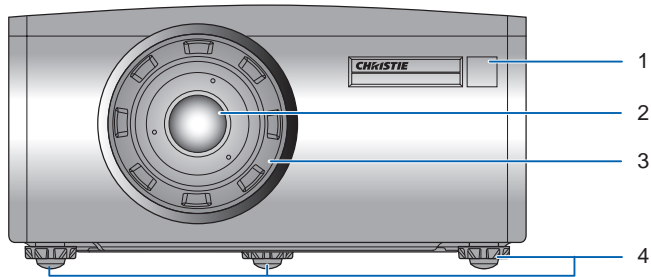

Ind.	Part Name	Description
1	Front IR Sensor	Receives signals from the IR remote. Keep the signal path to the sensor unobstructed for uninterrupted communication with the projector.
2	Projection Lens	Allows automated lens control and adjustment: vertical and horizontal offsets, zoom and focus.
3	Lens Ring	Protects the lens motors and mechanism. Remove in order to insert or remove the lens.
4	Adjustable Feet	Raise or lower the feet to level the projector.

Rear View

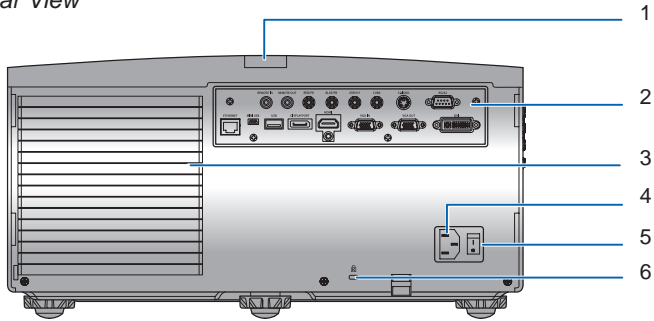

Ind.	Part Name	Description
1	Rear IR Sensor	Receives signals from the IR remote. Keep the signal path unobstructed for uninterrupted communication with the projector.
2	Input/Output (I/O) Panel	Connects the projector to external devices.
3	Cooling Air Vents (Exhaust)	Keep these vents unobstructed to prevent the projector from overheating.
4	AC Input	Connect to the supplied power adapter.
5	Power Button	Switch the power button to turn on the power source.
6	Kensington Lock	Use to secure the projector to countertops, tables, etc.

Left View

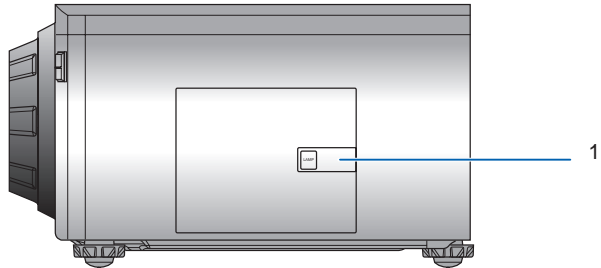

Right View

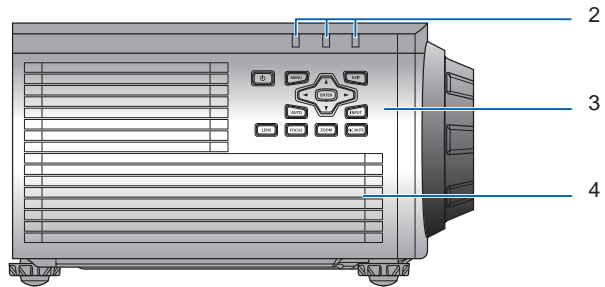

Ind.	Part Name	Description
1	Lamp Door	Use the lamp door to access the lamp module.
2	LED Status Indicators	Displays the status of the projector. They are (from left to right): LAMP, STATUS, and PIC MUTE.
3	Built-in Keypad	Controls the projector.
4	Cooling Air Vents (Intake)	Keep these vents unobstructed to prevent the projector from overheating.

2.2 Built-in Keypad

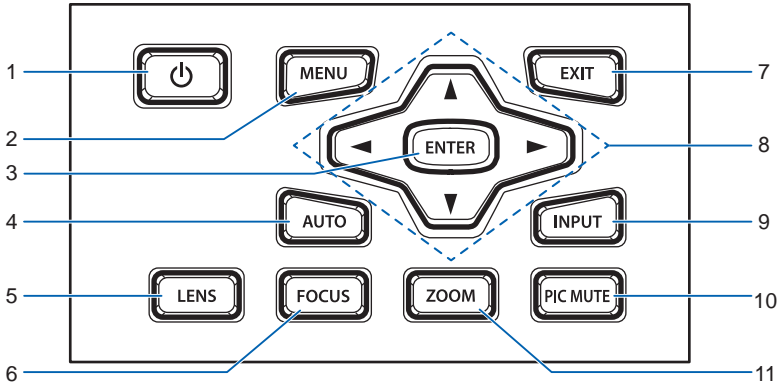

Ind.	Key Name	Description
1	Power	Turn the projector on or off
2	Menu	Display menus
3	Enter	Confirm a selection
4	Auto	Automatically optimize image
5	Lens	Adjust the lens vertical or horizontal offset setting
6	Focus	Adjust focus
7	Exit	Return to previous level or exit menus if at top level
8	Arrow Keys	<ul style="list-style-type: none"> Adjust a setting UP or DOWN Navigate within a menu
9	Input	Select an input for the main or PIP/PBP image
10	Picture Mute	Display or blank the video image.
11	Zoom	Adjust zoom

2.3 Input/Output (I/O) Panel

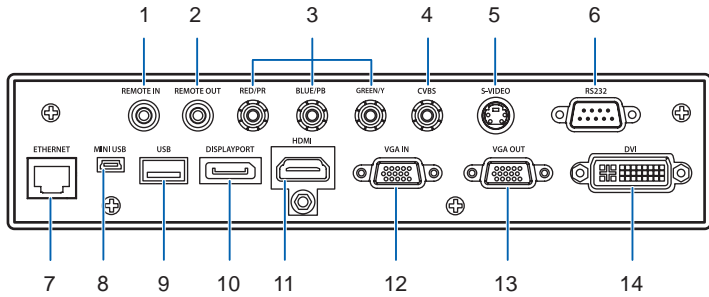

Ind.	Connector Name	Ind.	Connector Name
1	Remote IN	8	Mini USB
2	Remote OUT	9	USB Type A
3	Component IN	10	DisplayPort
4	CVBS	11	HDMI
5	S-Video	12	VGA-IN
6	RS232	13	VGA OUT
7	Ethernet	14	DVI

2.4 Remote Control

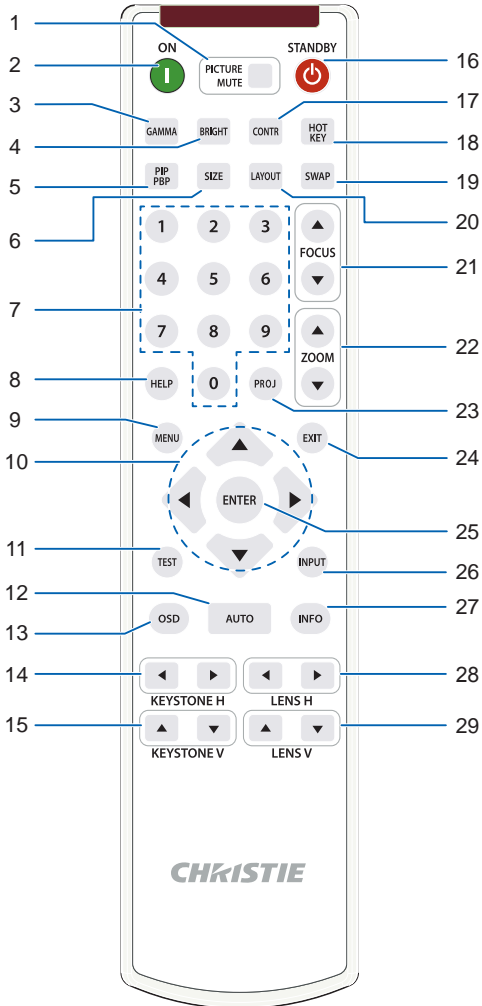

Ind.	Key Name	Description
1	Picture Mute	Display or blank the video image.
2	Power on	Turn projector ON.
3	Gamma	Adjust mid-range levels.
4	Bright	Adjust amount of light in the image.
5	PIP/PBP	Turn PIP/PBP ON/OFF.
6	Size	Adjust the PIP/PBP size
7	Number Keys	Enter a number, such as a channel, value, etc.
8	Help	Display context-sensitive help.
9	Menu	Display menus.
10	Arrow Keys	<ul style="list-style-type: none"> Adjust a setting UP or DOWN. Navigate within a menu.
11	Test	Display a test pattern.
12	Auto	Automatically optimize image.
13	OSD	Use to hide or show menus.
14	Keystone H	Adjust the horizontal keystone.
15	Keystone V	Adjust the vertical keystone.
16	Standby	Turn projector OFF.
17	Contrast	Adjust difference between dark and light.
18	Hot-key	Select your preset keys quickly.
19	Swap	Swap the main and PIP/PBP images.
20	Layout	Adjust the PIP/PBP layout.
21	Focus	Adjust focus to improve image clarity as desired.
22	Zoom	Adjust zoom to achieve a desired image size.
23	Proj Key	Change the remote ID. Press Proj Key then a number between 1 and 9 to assign an ID. Press PROJ then number 0 to return to the universal remote ID.
24	Exit	Return to previous level or exit menus if at top level.
25	Enter	<ul style="list-style-type: none"> Select a highlighted menu item. Change or accept a value.
26	Input	Select an input for the main or PIP/PBP image.
27	Info	Display source image information.
28	Lens H	Horizontal Lens Shift - Adjust the position of the image horizontally.
29	Lens V	Vertical Lens Shift - Adjust the position of the image vertically.

2.5 LED Status Indicators

The LED status indicators are located on the right side of the projector. Each LED is defined below.

- LAMP LED

LED Status	Projector State
Red (short blink)	Failed to strike lamp after 5 attempts (strike attempts will stop). Lamp has unexpectedly shut down (system goes into cool down state).
Yellow (no blink)	Lamp time has expired and lamp should be replaced. (projector also begins to display the replace lamp OSD message at startup).
Green (no blink)	Lamp is ON and operating correctly
Green (short blink)	Projector lamp is switching on
Off	Lamp is off

- STATUS LED

LED Status	Projector State
Off	Projector is in OFF state (without AC plug in)
Off, but keypad LED is on	Projector is in standby mode (AC plug in)
Green (no blink)	Projector is powered up and operating normally
Flashing Yellow	Projector is in cool down mode or startup mode
Flashing Green/ Yellow	Projector is in flash update state
Red (short blink)	Fan failure
Red (no blink)	Over-temperature
Green (blink very quickly)	Projector communications (Read/Write EEPROM)

- PICTURE MUTE LED

LED Status	Projector State
Green	Picture mute is off – image is displayed
Yellow	Picture mute is on – image is black

3. INSTALLATION

3.1 Connect to Computer

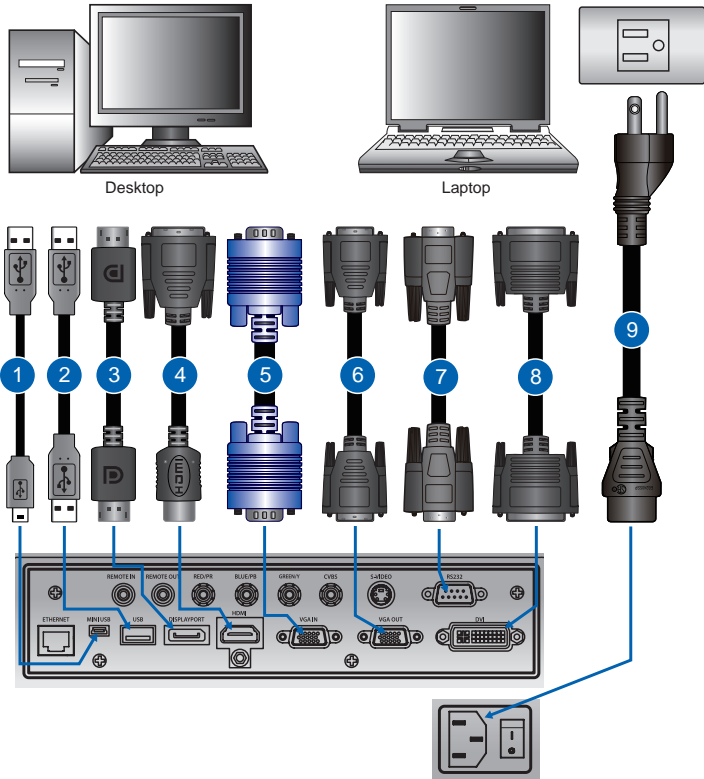

Ind.	Connector Name	Ind.	Connector Name	Ind.	Connector Name
1	USB Type B Mini Cable	4	HDMI Cable	7	RS232 Cable
2	USB Type A Cable	5	VGA in Cable	8	DVI Cable
3	DisplayPort Cable	6	VGA out Cable	9	Power Cord

NOTE:

- ❖ The diagram shows the cables/connectors that may be used to connect to various devices.
- ❖ Due to the difference in applications for each country, the accessories required in some regions may be different from those shown.
- ❖ This diagram is for illustrative purposes only, and does NOT indicate that these accessories are supplied with the projector.

3.2 Connect to Video Equipment

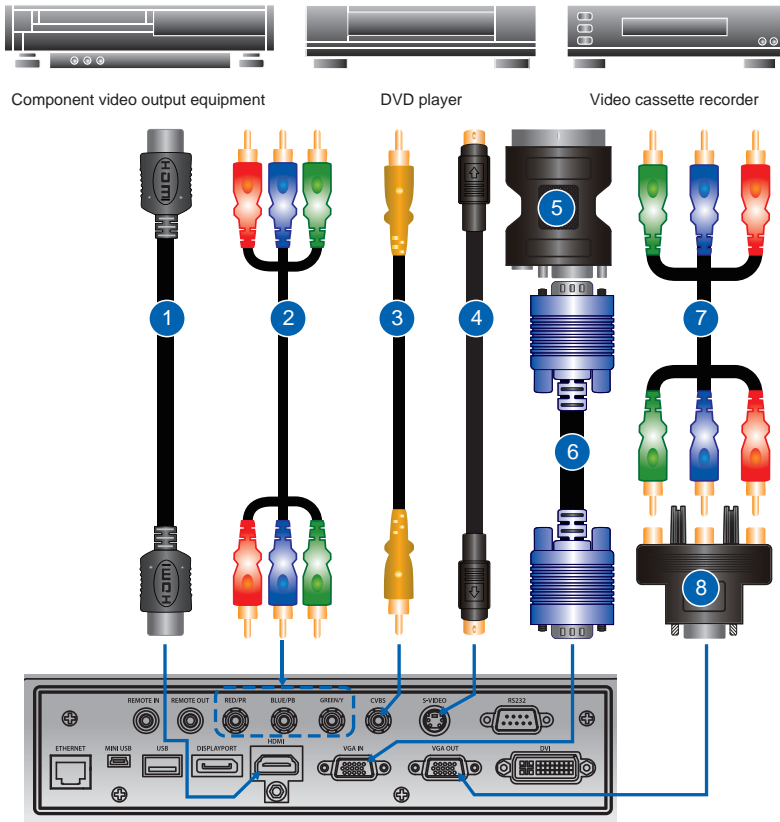



Ind.	Connector Name	Ind.	Connector Name	Ind.	Connector Name
1	HDMI Cable	4	S-Video Cable	7	3 RCA Component Cable
2	Component (YPbPr) Cable	5	VGA to RGB SCART	8	15-pin to 3 RCA Component/HDTV Adapter
3	CVBS Cable	6	VGA in Cable		

NOTE:

- ❖ The diagram shows the cables/connectors that may be used to connect to various devices.
- ❖ Due to the difference in applications for each country, the accessories required in some regions may be different from those shown.
- ❖ This diagram is for illustrative purposes only, and does NOT indicate that these accessories are supplied with the projector.

3.3 Turn the Projector On



1. Ensure that the power cord and signal cable are securely connected. The Power button on the built in keypad is illuminated. ❶
2. Turn on the lamp by pressing “” on the remote control or press “” on the built-in keypad. The Status LED is yellow with a long blink. ❷
The startup screen displays in approximately 10 seconds.
3. Turn on the source. Select Input Key on the remote control to select an input source (VGA, BNC, HDMI, Component, S-Video or Composite Video). ❸
4. The projector detects the source you selected and displays the image.

NOTE:

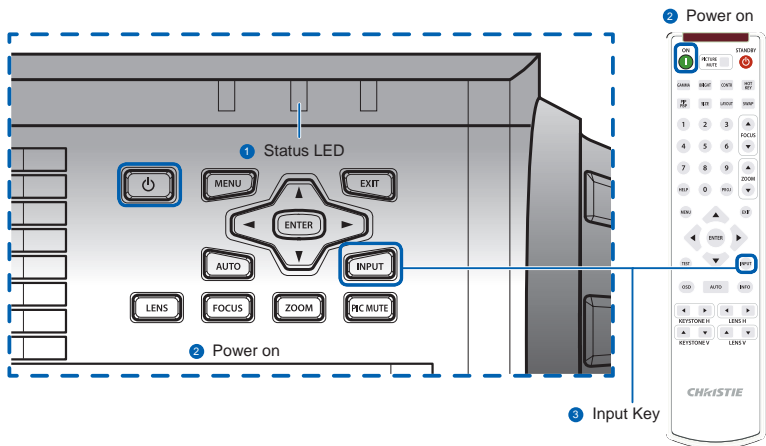
❖ *The first time the projector is used, the preferred language may be selected from the main menu after the startup screen is displayed.*



3.4 Turn the Projector Off

1. Press “” on the built-in keypad or on the remote control to turn off the projector. A warning message will appear on the displayed image.
2. Press “” again to confirm your selection. If you do not press “” again, the warning message will disappear after 10 seconds.

3.5 Adjust the Projector Position

When you select a position for the projector, consider the size and shape of your screen, the location of your power outlets, and the distance between the projector and the rest of your equipment. Follow these general guidelines:

- Position the projector on a flat surface at a right angle to the screen. The projector (with the standard lens) must be at least 3 feet (0.9m) from the projection screen.
- Position the projector to the desired distance from the screen. The distance from the lens of the projector to the screen, the zoom setting, and the video format determine the size of the projected image.
- For the fixed short lens, the image exits at a default angle. However, the lens shift feature makes the image offset variable.
- Lens throw ratio:
 - Lens 1.22~1.53 (WU/HD)
 - Lens 0.95~1.22 (WU/HD)
 - Lens 1.52~2.92 (WU/HD)
 - Lens 1.28-1.61 (WX)
 - Lens 1.0-1.28 (WX)
 - Lens 1.6-3.07 (WX)
- Do not roll the projector more than 20 degrees from side to side.
- Do not put the projector on either side to project an image.

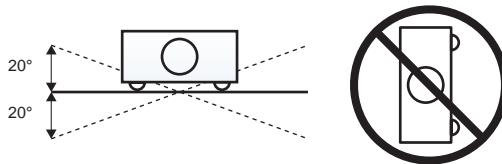

- 360 degree operation (along the widest axis)

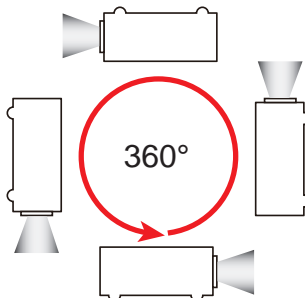

3.6 Calculate Lens Offset

- The vertical image offset (shift) ranges for the projector are +/-100% (WXGA/WUXGA) and +/-120% (HD). The horizontal image offset (shift) range for the projector are +/-20% (WXGA/HD/WUXGA).
- The method for calculating lens offset complies with Industry standards. Example for Vertical lens offset:
 - At 0% offset (or on axis), the center of the image is on the lens center, so that half of the image appears above and half appears below the lens center.
 - At +100% offset, all (or 100%) of the image will appear above the lens center.
 - The % offset is calculated as the ratio of the number of pixels shifted up/down to half the image size. Examples for WUXGA:
 - ▶ Shifting up 600 pixels gives offset of $600/600 * 100\% = 100\%$
 - ▶ Shifting down 600 pixels gives offset of $-600/600 * 100\% = -100\%$
 - ▶ Shifting up 720 pixels gives offset of $720/600 * 100\% = 120\%$
 - ▶ Shifting up 240 pixels gives offset of $240/600 * 100\% = 40\%$

WUXGA Projectors:

Vertical Image Offset: 0% Offset (WUXGA)

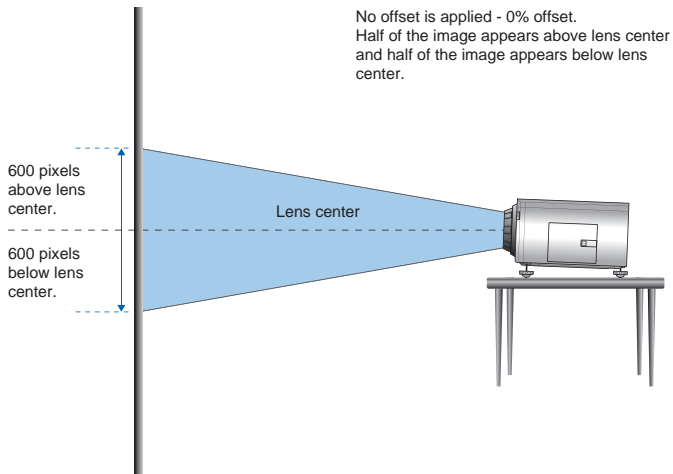

Vertical Image Offset: 100% Offset (WUXGA)

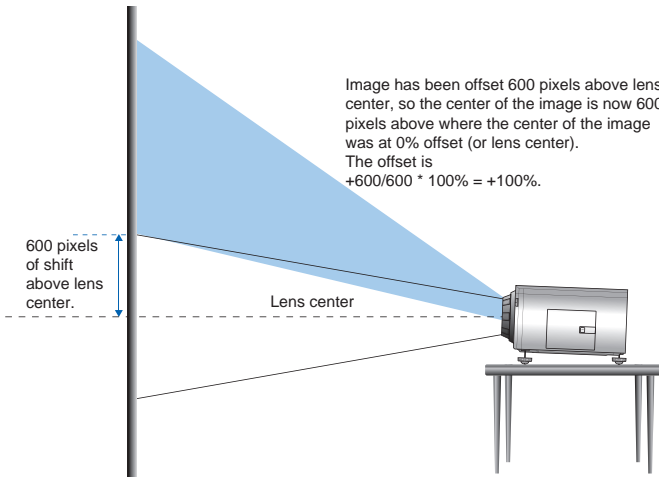

Vertical Image Offset: -100% Offset (WUXGA)

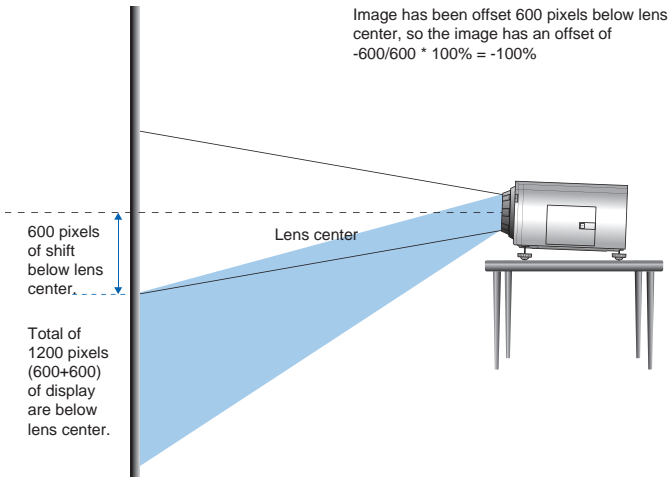

HD Projectors:

Vertical Image Offset: 0% Offset (HD)

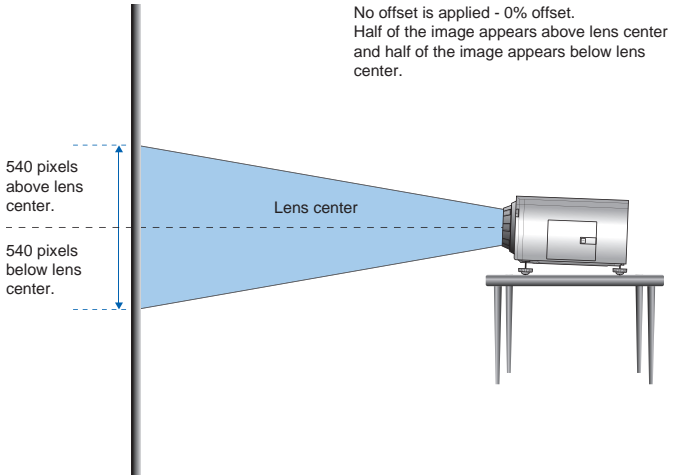

Vertical Image Offset: 120% Offset (HD)

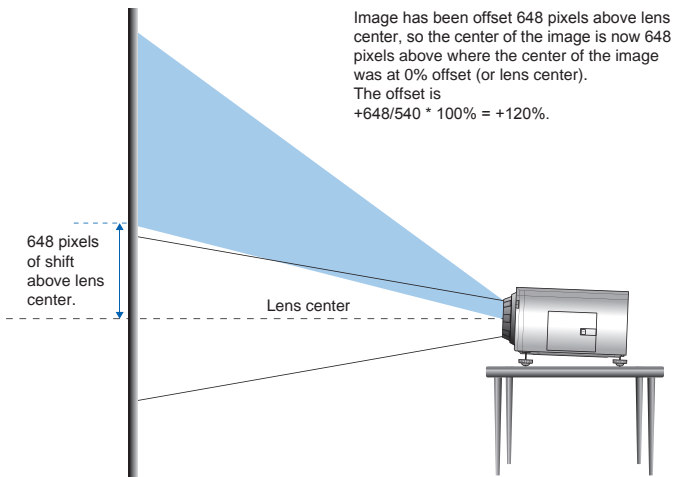

Vertical Image Offset: -120% Offset (HD)

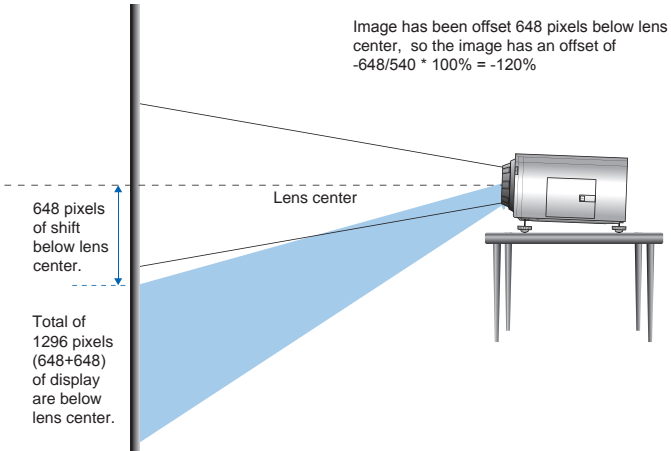

Horizontal Image Offset: +/-20% Offset

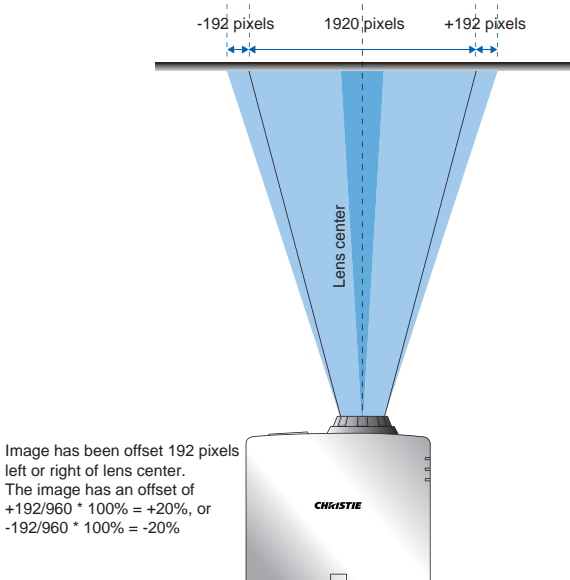

WXGA Projectors:

Vertical Image Offset: 0% Offset (WXGA)

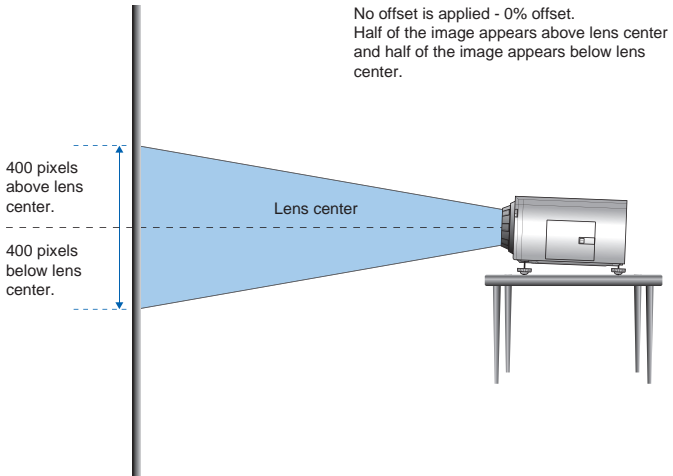

Vertical Image Offset: 100% Offset (WXGA)

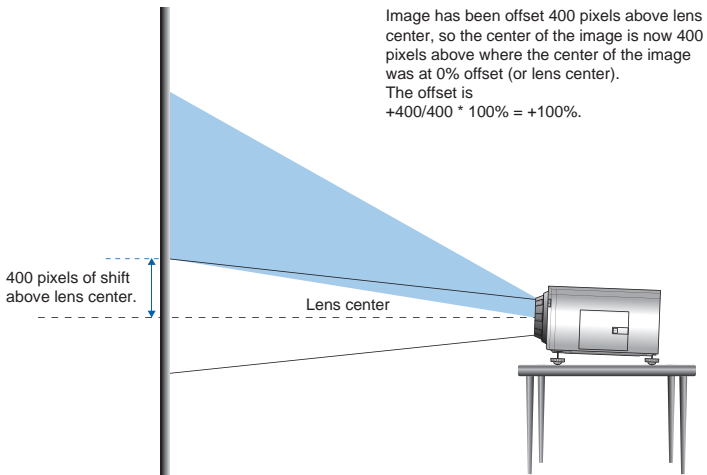

Vertical Image Offset: -100% Offset (WXGA)

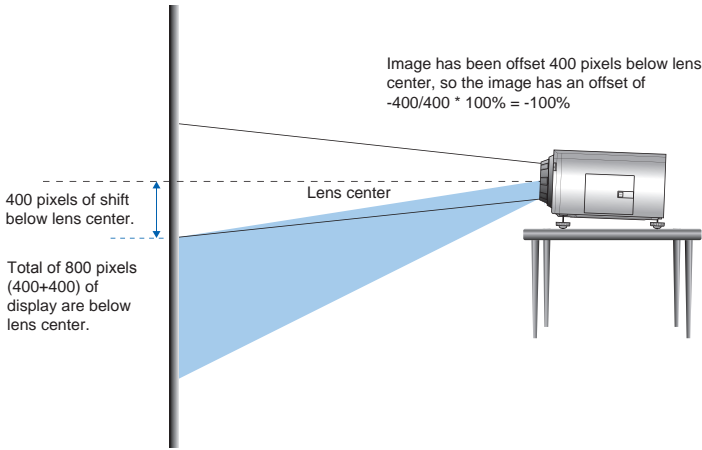

Horizontal Image Offset: +/-20% Offset

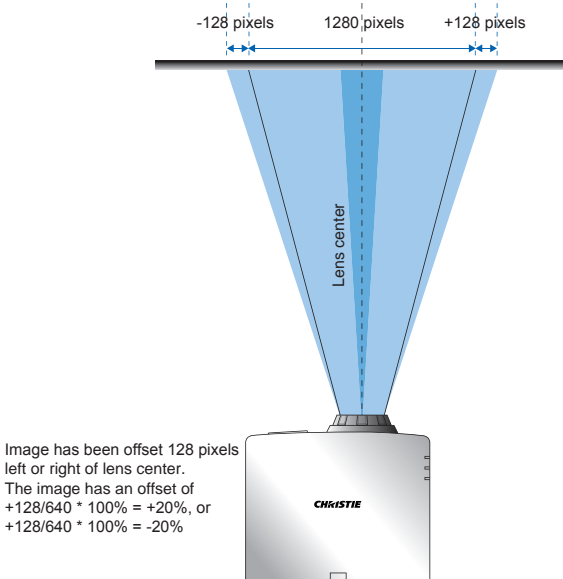

3.7 Removing and Installing the Lens

When handling the projector after lens installation, make sure the front lens cap is placed on the lens to protect the lens surface from potential damage. When carrying or moving the projector, do not handle by the lens. This may damage the lens, the chassis or other mechanical parts within the projector.

Installation Steps:

1. **Center the lens:** Ensure that the lens is at or near its center position. Attempting to remove the lens when at a large offset may cause damage to the lens assembly. Center the lens while the projector is switched on by pressing the lens horizontal or vertical button and then pressing Enter.
2. **Turn Off the projector:** Turn the projector OFF.
3. **Wait for projector to cool down:** Allow the projector to cool down into standby mode before replacing the lens. Remove power cord after the projector has cooled down and prior to replacing the lens.
4. **Remove the lens:** Remove the lens ring cover. Rotate the lens counter-clockwise by a quarter to release the lock. Remove the lens through the front of the projector.

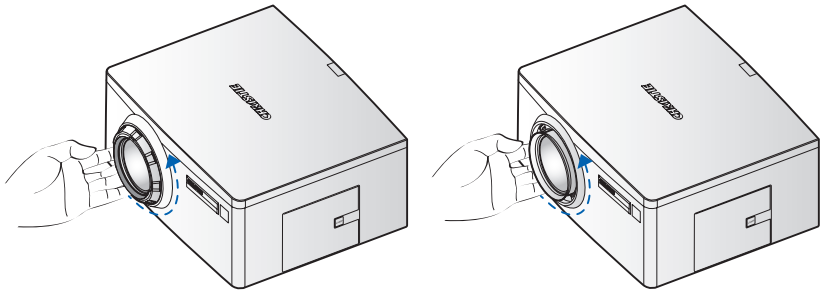

5. **Install the new lens:** Fully insert the lens assembly straight into the lens mount without turning. Rotate the lens cap clockwise to lock the lens in place.

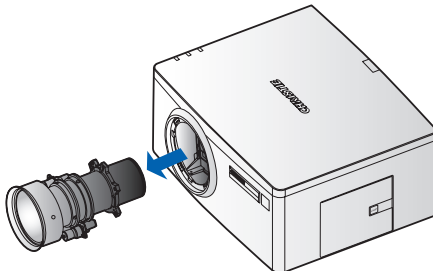

3.8 Cable Cover Installation

1. Rotate the cable cover and insert the two guide pins into the guide holes.
2. Press and hold both lower corners of the cable cover while inserting the sheet clips into the projector casing.

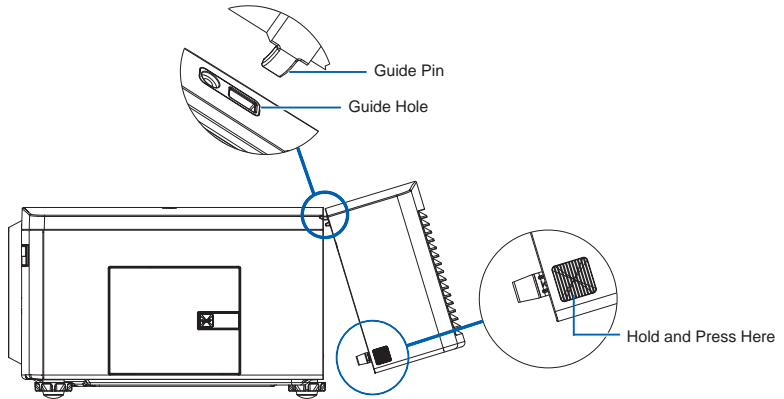

4. OPERATION

The projector has multilingual On-Screen Display (OSD) menus that allow you to make image adjustments and change a variety of settings.

- Most of the projector controls are accessed from within the projector menu system. There are several groups of related functions, with each group selectable from the Main menu as shown below. Press the MENU button on the remote control or on the built-in keypad on the rear of the projector to display the main menu.
- Use the arrow keys to navigate within the menu and adjust a setting up or down.
- Press ENTER to select a highlighted menu item or use it to change or accept a value.
- Select the next item that you want to adjust in the menu and adjust it as described above.
- Press EXIT to return to the previous menu or exit menus if at top level.

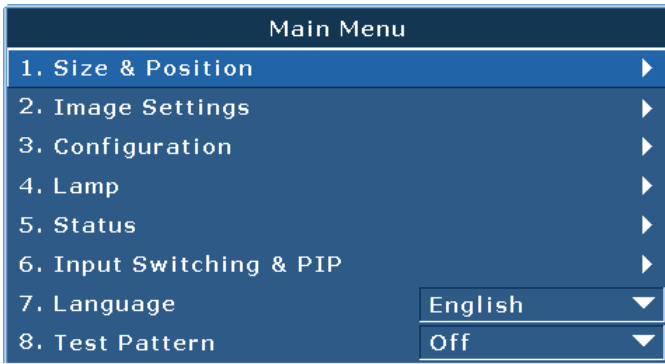

4.1 Size and Position Menu

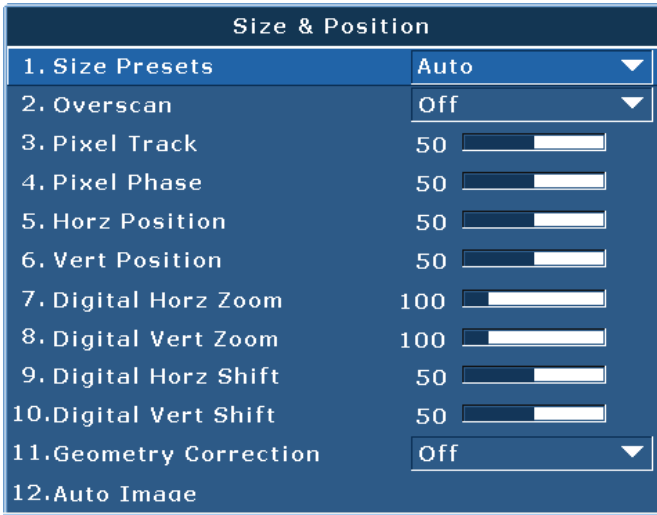

Size Presets

Display an image with the detected size, or resize the image by maximizing either the height, width or both, or resize to the maximum size possible while keeping the original aspect ratio.

- Auto: Display with the detected size.
- Native: Display in its native resolution.
- 4:3: Retain 4:3 aspect ratio.
- Letterbox: Display with the black borders on the top and bottom.
- Full Size: Fill the screen (regardless of the source).
- Full Width: Fill display width and keep aspect ratio.
- Full Height: Fill display height and keep aspect ratio.
- Custom: Stretch the display horizontally or vertically without cutting the image display

Overscan

Remove noise around the image. Overscan Zoom enlarges image 6% from original size. Overscan Crop cuts 6% of active pixels in four edges of original image.

Pixel Track

Analog RGB signals only. Steady flickering or several soft vertical stripes or bands across the entire image indicates poor pixel tracking. Proper pixel tracking ensures that the image quality is consistent across the screen, the aspect ratio is maintained, and that the pixel phase can be optimized.

Pixel Phase

Analog RGB Signals only. Adjust pixel phase when the image still shows shimmer or noise after pixel tracking is optimized. Pixel phase can adjust the phase of the pixel-sampling clock relative to the incoming signal.

Horz Position

Move the image right or left within the area of available pixels.

Vert Position

Move the image up or down within the area of available pixels.

Digital Horz Zoom

Change the size of projector's display area horizontally. If the display area has been resized by this setting, it can be moved by changing the Digital Horz Shift and Digital Vert Shift settings.

Digital Vert Zoom

Change the size of projector's display area vertically. If the display area has been resized by this setting, it can be moved by changing the Digital Horz Shift and Digital Vert Shift settings.

Digital Horz Shift

Move the display area horizontally if its size has been changed by the Digital Zoom setting.

Digital Vert Shift

Move the display area vertically if its size has been changed by the Digital Zoom setting.

Geometry Correction

The "Geometry Correction" can be controlled with the options in the drop-down list: "Off/Basic" when optional Dual Processor Warp Module is not installed, and "Off/Basic/Curve/Rotate" when optional Dual Processor Warp Module is installed.

Geometry Correction Feature Compatibility

Warp Function	4-Corner	Curved Surface(2x2)	Keystone	Pincushion and Barrel	Rotation
4-Corner	--	✓	✓	✓	✓
Curved Surface(2x2)	✓	--	X	X	X
Keystone	✓	X	--	✓	X
Pincushion and Barrel	✓	X	✓	--	X
Rotation	✓	X	X	X	--

- Off: No Geometric correction is applied to the image.
- Horz Keystone: Adjust the keystone horizontally and make a more square image. Horizontal keystone is used to correct a keystoneed image shape in which the left and right borders of the image are unequal in length, and the top and bottom are slanted to one of the sides. This is intended for use with horizontally on-axis applications. For horizontally offset applications, you must use 4 Corner correction using the optional Dual Processor Warp Module.

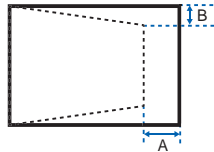
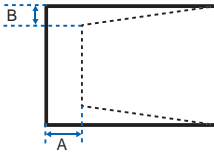

Ind.	WXGA	1080P	WUXGA
A	12.3%	10.2%	7.1%
B	7.7%	6.4%	5.2%

- Vert Keystone: Adjust the keystone vertically and make a more square image. Vertical keystone is used to correct a keystoneed image shape in which the left and right borders of the image are unequal in length, and the top and bottom are slanted to one of the sides. This is intended when for use with horizontally on-axis applications. For horizontally offset images, you must use 4 Corner correction using the optional Dual Processor Warp Module.

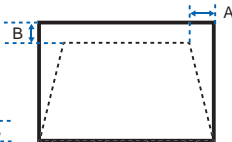
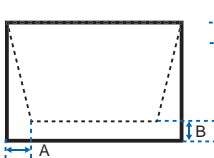

Ind.	WXGA	1080P	WUXGA
A	5.4%	4.4%	3.3%
B	10.4%	8.7%	5.4%

- Horz Pincushion: Adjust the pincushion horizontally and make a more square image.

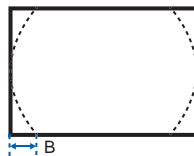
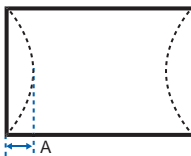

Ind.	WXGA	1080P	WUXGA
A	16.0%	13.3%	8.0%
B	16.0%	13.2%	7.9%

- Vert Pincushion: Adjust the pincushion vertically and make a more square image.

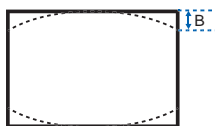
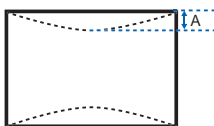

Ind.	WXGA	1080P	WUXGA
A	14.7%	12.3%	11.4%
B	14.7%	12.1%	11.4%

- Pincushion/Barrel: Allow for correction for slight curved distortion from the lens or projection surface.

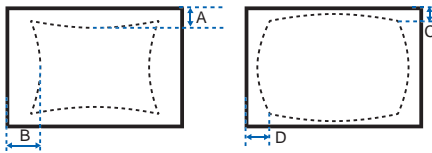

Ind.	WXGA	1080P	WUXGA
A	8.3%	8.35%	8.37%
B	3.5%	3.98%	4.59%
C	6.4%	6.4%	6.5%
D	6.4%	6.4%	6.4%

- 4-Corner: Allow the image to be squeezed to fit an area defined by moving each of the four corners' x and y position.

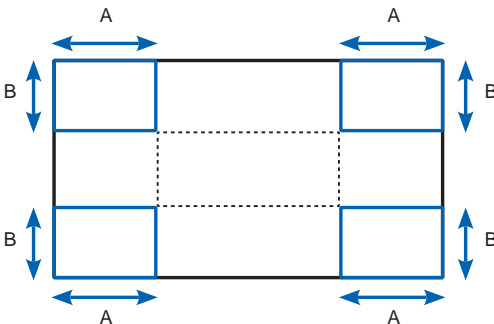

Ind.	WXGA	1080P	WUXGA
A	10.0%	8.4%	8.3%
B	9.5%	7.9%	7.0%

- Rotation: Allow an image to be rotated – most commonly to level the image. While the image is rotated, the software can crop any content that begins to fall off the panel. The function will not automatically scale the image down to prevent cropping. If scaling is required, the digital zoom function can be used, independently of the rotation function.

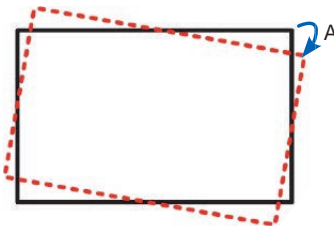

Ind.	WXGA	1080P	WUXGA
A	±8.0°	±8.0°	±7.9°

Auto Image

Force the projector to reacquire and lock to the input signal. This is useful when signal quality is marginal. "Normal mode" can support all of the 4:3 input sources.

"Wide mode" can support all of the 16:9 input source & most of the 4:3 input source. For those 4:3 input sources not recognized by "Wide mode" (example 1400 x 1050), perform Auto Image using "normal mode".

4.2 Image Settings Menu

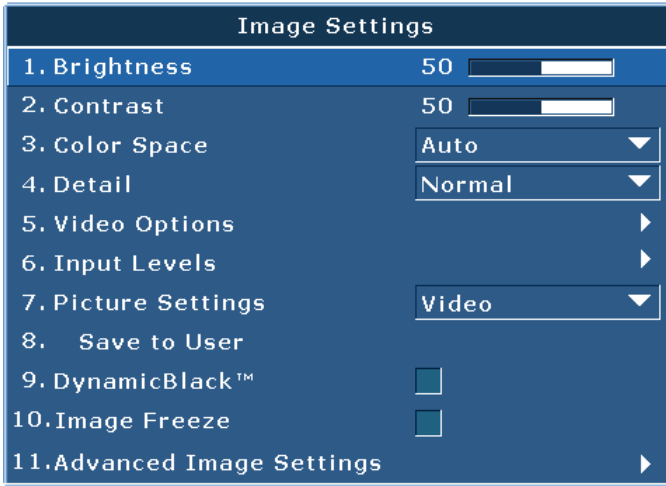

Brightness

Adjust the intensity of the image.

Contrast

Adjust the degree of difference between the lightest and darkest parts of the picture and change the amount of black and white in the image.

Color Space

Select a color space that has been specifically tuned for the input signal. Useful only for analog signals and certain digital sources.

Detail

Select the edge clarity of the image.

Video Options

This function is used with video sources only.

- Color: Adjust a video image from black and white to fully saturated color. The color setting applies to video sources only.
- Tint: Adjust the red-green color balance in the image of NTSC video images. The tint setting applies to NTSC video sources only.
- Noise Reduction: Reduce temporal or spatial noise in the image.
- Flesh Tone Correction: Control the amount of flesh tone correction applied to the image.

- **Video Black Level:** Analyze the current input image and calculate an offset value which is then added to the analog to digital converter black level value. This ensures optimum black level for each analog source.
- **Detect Film:** Control film mode detection and determine whether the original source of the input video was film or video.
- **Closed Captions:** Control closed caption display while audio is not muted. If this setting is not off, audio is not muted, the source is NTSC and contains captions on the selected channel, then the projector must display caption text overlaid on the image.

Input Levels

VGA / Component signals only.

- Adjust the gain of the red, green, or blue channel of the image. It will affect the black and white.
- Adjust the offset of the red, green, or blue channel of the image. It will affect the black and white.
- **Sync Threshold:** (progressive signals only) If a hardware device, such as a DVD player, is not syncing properly with the projector, select this option to help it to sync when connected to the projector.

Picture Settings

Optimize the projector for displaying images under certain conditions, such as presentation, video, bright, whiteboard, blackboard, beige wall and user-definable preset. It will affect Gamma, Sharpness, White Peaking, Overscan, Brightness, Contrast, Color, Tint, Red Gain, Green Gain, Blue Gain, Red Offset, Green Offset, Blue Offset.

Save to User

Adjust the image settings and select Save to User as a picture setting. You can recall these settings in the future by selecting the User in the Picture Settings menu. The setting of Brightness, Contrast, Color, Tint, Red Gain, Green Gain, Blue Gain, Red Offset, Green Offset, Blue Offset, Color Temp, Gamma, Detail, BrilliantColor, Whitepeaking and Overscan will be saved.

DynamicBlack™

Select the check box to constantly adjust the aperture based on the amount of black in the current scene.

Image Freeze

Pause the screen image.

Advanced Image Settings

- Gamma: Select the appropriate gamma from Video, Film, Bright, and CRT.
- BrilliantColor™: Produce an expanded on-screen color spectrum that delivers enhanced color saturation for bright, true-to-life images.
- White Peaking: (video source only) Increase the brightness of whites that are near 100%.
- Color Temperature: Change the intensity of the colors. Select a listed relative warmth value.
- Edge Enhancement: Apply the edge enhancement process.

4.3 Configuration Menu

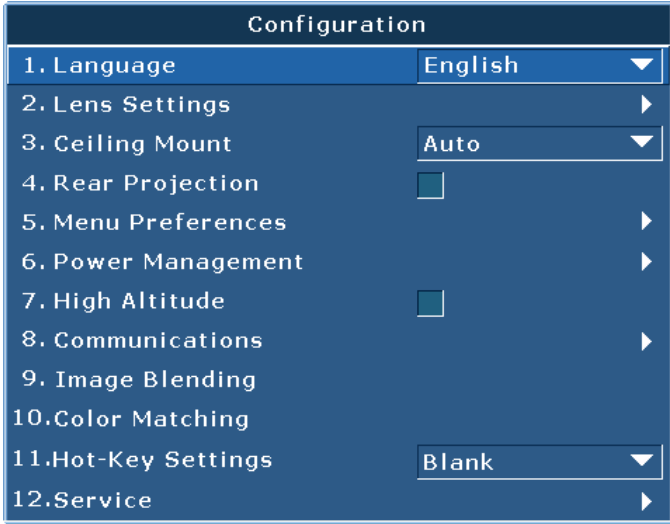

Language

Allows you to select an available language for the OSD display, from English, French, German, Italian, Spanish, Chinese(simplified), Japanese, Korean, and Russian.

Lens Settings

- Focus and Zoom: Adjust the focus and zoom the image in or out.
- Lens Shift: Shift the lens up and down or left and right.
- Lock Lens Motors: Select this function to prevent all lens motors from moving. It will disable the Zoom, Focus, Horizontal and Vertical Position settings, effectively locking out any changes and overriding all other lens features. This is particularly useful to prevent accidental lens position changes in multi-projector installations.
- Lens Calibration: Calibrate the lens center

Ceiling Mount

Turn the image upside down for ceiling-mounted projection.

Rear Projection

Reverse the image so you can project from behind a translucent screen.

Menu Preferences

- Menu Horz Position: Change the horizontal position of the OSD.
- Menu Vert Position: Change the vertical position of the OSD.
- Show Messages: Display status messages on the screen.
- Menu Transparency: Change OSD menu background to be transparent.

NOTE:

❖ *As the value increases, more of the image behind the menu is visible.*

- Splash Screen: Choose which splash screen is to be used.
- PIN Protect: The PIN (personal identification number) feature allows you to password protect your projector. Once you enable the PIN feature, you must enter the PIN before you can project an image.
- Change PIN: Allows you to change the PIN.

Power Management

- Standby Mode: The projector is in standby mode when connected to AC power. (<0.5W)
- AC Power On: The projector automatically turns on when electrical power is connected.
- Auto Shutdown: Automatically turns the projector off after no signals are detected for a preset number of minutes. If an active signal is received before the projector powers down, the image will be displayed.
- Sleep Timer: Allows the projector to automatically power off after it has been on for a specified amount of time.

High Altitude

Set high altitude mode ON/OFF. When ON, the fan will operate at high speed to ensure sufficient air flow for high altitudes.

Communications

- Network: Allow you to setup network settings.
 - DHCP: Turn the DHCP ON/OFF.
 - IP Address: Assign Network IP Address.
 - Subnet Mask: Assign Network Subnet Mask.
 - Default Gateway: Assign Network Default Gateway.
 - Host Name: Display the host name.
 - MAC Address: Displays network MAC Address value.
 - Show Network Messages: Turn network messages ON/OFF.
 - Restart Network: Restart the network.
 - Network Factory Reset: Perform factory reset on the network settings. The Projector Name, LAN IP, WLAN IP, and SNMP settings will be reset.
- Baud Rate: Select the serial port and baud rate.

- Serial Port Echo: Control whether the serial port echoes characters.
- Projector Address: Set the projector address (0-9). The projector will respond to IR remotes set either at the same address as the projector or to IR remotes set to address 0.

Image Blending

Adjust blend widths and settings to left, right, top and/or bottom sides to create a seamless multi-projector stitched image. (Available only when optional Dual Processor Warp Module is installed.)

What is a Blend?

In simple terms, a blend appears as a gradient strip along an edge of a projected image. It is darkest along the extreme edge of the image, and lightens nearer to the rest of the image(see below).



How are Blends used?

In multiple-projector wall, complementary blends between neighboring images can compensate for the extra “brightness” or intensity where these edges overlap. By controlling blend width and other properties, you can achieve uniformity across the group of images. “Visible overlaps will disappear, as shown below”

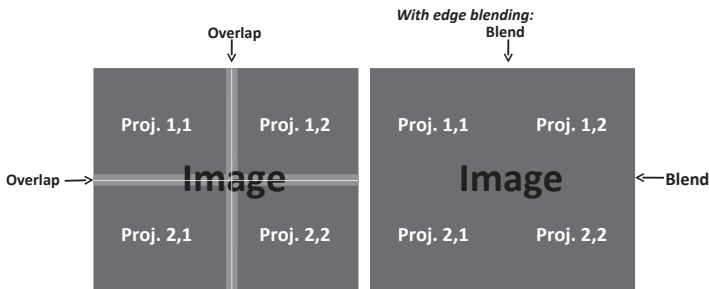

Blending regions can be defined on all sides – left, right, top and bottom. The same gamma curve is used for all blending regions.

Color Matching

You may require a unique color gamut (range) for a single projector or application, or you may need to precisely match colors across multiple adjacent displays. Use Color Matching by Meter Adjustment or by Manual Adjustment to define the precise hue of each primary color component (red, green, blue and white).

The x/y coordinates for each color define its location on the standard CIE chromaticity graph. Changing either or both of these numbers will change the hue of the color, and modify the range of possible colors. For example, changing the x/y coordinates for red may move the color closer to orange or closer to violet, which will in turn affect all displayed colors having a red component. Adjust the slide bars or enter new specific coordinates as desired to define or change the color gamuts needed for your environment and applications.

Enable the selected method (Meter or Manual Adjustment)— this will automatically disable the other method. For both methods, if Auto Test Pattern is enabled, the solid colored test pattern will be displayed according to the menu item on which you are positioned.

- Meter Adjustment
 1. Using a color meter, enter the current x and y co-ordinates of Red, Green, Blue and White for the projector image into the Measured Data menu. This is the reference point for the projector. The default values in the menu are based on the average for all projectors.
 2. After measuring the values for all the projectors to be matched, calculate the target values.
 3. Enter the target values for x, y and gain for each color into the Target Data menu.

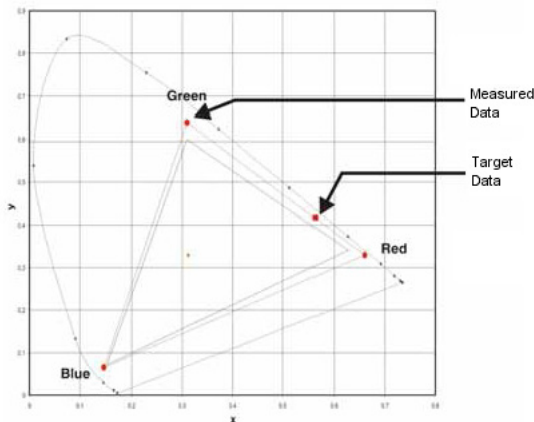

- Manual Adjustment
 1. Adjust color slide bars and judge image color by eye or meter. A user-defined color “adjustment” can be applied.
 2. Use this submenu if you do not have specific color coordinates in mind and will judge color performance by eye or meter. As for Meter Adjustment, each color control actually defines new x/y coordinates for that color and changes its hue. The main colors (red part of red, green part of green and blue part of blue) adjust the intensity of that color component, while the modifying colors (e.g. green part of red and blue part of red) modify the x and y value and change the hue of that color. At the same time the main colors also are used to control the color of the white point.

Hot-Key Settings

Assign a different function to the hot-key on the remote control by highlighting the function in the list and pressing ENTER. Choose a function that does not already have a dedicated button, and assign the hot-key to that function, allowing you to quickly and easily use the chosen function.

Service

- Projector Info: Display current projector settings (read-only).
- Factory Reset: Restore all settings to their default value. It will not reset network but it will reset RS232.
- Test Pattern: Choose the desired internal test pattern to display, or select OFF to turn off a test pattern.
- Color wheel Index (2x): Set Color wheel index to Speed 2X. This setting only needs to be used when the Main Board is changed, and should be adjusted to optimize picture quality.
- Color wheel Index (3x): Set Color wheel index to Speed 3X. This setting only needs to be used when the Main Board is changed, and should be adjusted to optimize picture quality.
- Error log: Show the projector error log for debug.
- Mode Adjustment: Fine tune the H and V start position for a signal in the EDID timing table and record the values in the system to override the timing table. The settings must be “Saved to Record” before exiting the menu, or they will be lost. To revert to original timing table settings, each setting must be manually cleared. Factory Defaults will not clear these override settings.
- Light Sensor: Calibrate the Light Sensor for use with the Constant Intensity lamp mode, which allows the projector to be set for constant brightness. If the Light Sensor has not been calibrated, Constant Intensity mode will be disabled. Light Sensor calibration should be repeated when new lamps are installed.

4.4 Lamp Menu

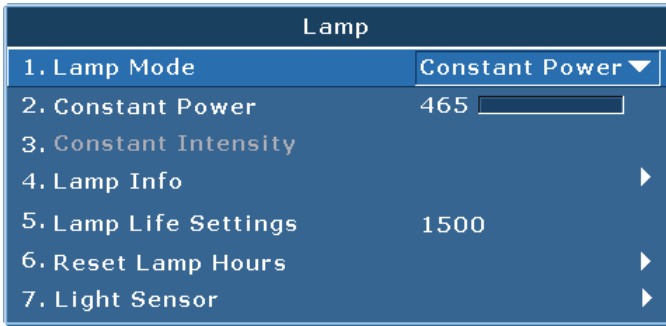

Lamp Mode

Select Constant Power, Constant Intensity or ECO mode. When in ECO mode, the projector will adjust to the lowest fan speed and switch the lamp power to the minimum setting.

Constant Power

Set the value of the lamp power (in Watts).

Constant Intensity

Set the value for the Constant Intensity to maintain constant brightness. The light sensor will monitor the light level and will apply more power as the lamp brightness decays naturally over time. When the lamp setting reaches maximum power of 370W, it will remain at this setting. Note that the light sensor needs to be calibrated for Constant Intensity mode to work properly. Calibration should be performed again after every lamp change.

Lamp Info

Display current lamp(s) settings (read-only).

Lamp Life Setting

Set the number of hours for the lamp life warning. After the lamp hours exceed this value, a lamp replace message will appear. Once the lamp hour exceeds the value of "Lamp Life Settings", a warning message box will be shown on screen and the Lamp LED will be solid yellow at the same time.

Reset Lamp Hours

Reset the lamp used hours counter to zero. Do this after changing the lamp.

Light Sensor

Calibrate light sensor.

4.5 Status Menu

The read-only Status menu lists a variety of details about the standard and optional components currently detected in the projector.

For DHD Models

Status	
Model Name	DHD600-G
Serial Number	G4YYWW000
Native Resolution	1920 x 1080
Firmware	V15, A22, B08
Main Input	VGA
Main Signal Format	720p
Main Pixel Clock	74.256MHz
Main Sync Type	Sync on Green
Main Horz Refresh	45.10kHz
Main Vert Refresh	60.0Hz
PIP/PBP Input	-
PIP/PBP Signal Format	-
PIP/PBP Pixel Clock	-
PIP/PBP Sync Type	-
PIP/PBP Horz Refresh	-
PIP/PBP Vert Refresh	-
Lamp Power Settings	465 W
Lamp Hours	70
Standby Mode	0.5 W Mode
Lens Lock Settings	Allow
IP Address	192.168.0.100
DHCP	No
System Temperature	38°C

For DWU Models

Status	
Model Name	DWU600-G
Serial Number	G3YYWW000
Native Resolution	1920 x 1200
Firmware	V15, A22, B08
Main Input	VGA
Main Signal Format	720p
Main Pixel Clock	74.256MHz
Main Sync Type	Sync on Green
Main Horz Refresh	45.10kHz
Main Vert Refresh	60.0Hz
PIP/PBP Input	-
PIP/PBP Signal Format	-
PIP/PBP Pixel Clock	-
PIP/PBP Sync Type	-
PIP/PBP Horz Refresh	-
PIP/PBP Vert Refresh	-
Lamp Power Settings	465 W
Lamp Hours	70
Standby Mode	0.5 W Mode
Lens Lock Settings	Allow
IP Address	192.168.0.100
DHCP	No
System Temperature	38°C

For DWX Models

Status	
Model Name	DWX600-G
Serial Number	G5YYWW000
Native Resolution	1280 x 800
Firmware	V15, A22, B08
Main Input	VGA
Main Signal Format	720p
Main Pixel Clock	74.256MHz
Main Sync Type	Sync on Green
Main Horz Refresh	45.10kHz
Main Vert Refresh	60.0Hz
PIP/PBP Input	-
PIP/PBP Signal Format	-
PIP/PBP Pixel Clock	-
PIP/PBP Sync Type	-
PIP/PBP Horz Refresh	-
PIP/PBP Vert Refresh	-
Lamp Power Settings	465 W
Lamp Hours	70
Standby Mode	0.5 W Mode
Lens Lock Settings	Allow
IP Address	192.168.0.100
DHCP	No
System Temperature	38°C

4.6 Input Switching & PIP Menu

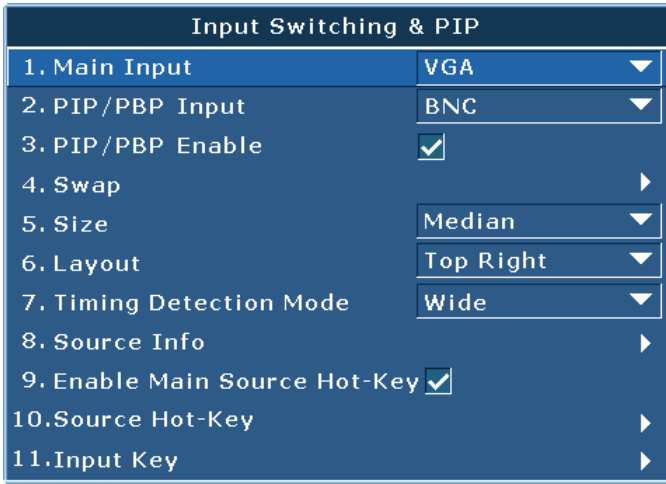

Main Input

From the list of active inputs, select one to be used as the main image.

PIP/PBP Input

From the list of active inputs, select one to be used as the PIP/PBP.

PIP/PBP Enable

Toggle between displaying two sources at once (Main and PIP/PBP images) or one source only. The check box turns the PIP/PBP source ON and OFF. Refer to Section 6.2 for the Main and PIP/PBP compatibility table.

Swap

Change the main image to PIP/PBP, and the PIP/PBP to main image. Swapping is available only when PIP/PBP is enabled.

Size

Select the PIP/PBP size to small, medium or large.

Layout

Set the location of the PIP/PBP image on the screen.

NOTE:

- ❖ PIP/PBP layout and size table as described below.
- ❖ P : indicates primary source region (lighter color).
- ❖ * : Both source regions are the same size.

PIP/PBP Layout	PIP/PBP Size		
	Small	Medium	Large
PBP, Bigger Left			
Over-Under, Bigger Upper			
PBP, Bigger Right			
Over-Under, Bigger Lower			
PIP-Bottom Right			
PIP-Bottom Left			
PIP-Top Left			
PIP-Top Right			

Timing Detection

Select timing detection mode to wide or normal. It is used to support additional PC timings. When the projected picture is not completed, this function is used to adjust the picture. "Normal mode" can support all of the 4:3 input sources. "Wide mode" can support all of the 16:9 input source & most of the 4:3 input source. For those 4:3 input sources not recognized by "Wide mode" (example 1400 x 1050), perform Auto Image using "normal mode".

Source Info

Display current source settings (read-only).

Enable Source Hot-Key

Toggle the check box to enable or disable the main source hot-key.

Source Hot-Key

Allows you to assign a different source to the hot-key. Highlight an input and press ENTER to choose a different one.

Input Key

Use it to list all of the sources or change the sources.

4.7 Language Menu

Allows you to select an available language for the OSD display.



4.8 Test Pattern Menu

Choose the desired internal test pattern to display, or select OFF to turn off a test pattern.

- OFF
- Black
- White
- Checkerboard
- Grid
- Color Bars

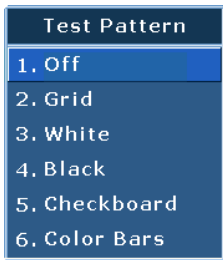

4.9 Web User Interface

4.9.1 Logging On

Open your web browser and type the IP address (in the address bar) assigned to your projector.

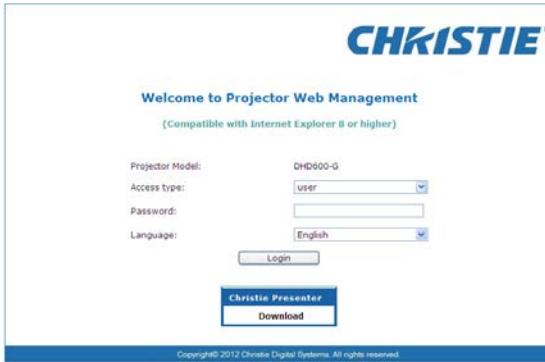

- 1 Select the log in level from the Access type drop-down list
- 2 Enter the Password in the Password field
- 3 Select the appropriate language from the Language drop-down list.
- 4 Click the Press login button. The Main window appears.

4.9.2 Main Tabbed Page – General

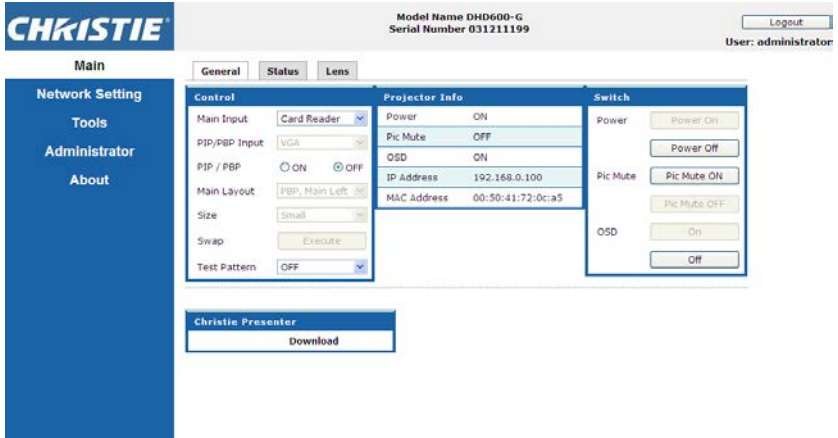

- Control Panel
Select main source / PIP source, enable/disable PIP/PBP, change the layout / PIP size, swap, and change the test pattern.
- Projector Information Panel
Check the projector information for power status, Pic mute status, OSD status, IP address and Mac address.
- Switch Panel
Switch the on/off status of power, Pic mute, and OSD.

4.9.3 Main Tabbed Page – Status

Display the current status of lamp info, cooling (fans), version numbers and signal (source) information

The screenshot shows the Christie projector web interface. At the top left is the Christie logo. The top right displays the model name 'DHD600-G' and serial number '031211199', along with a 'Logout' button and the user name 'User: administrator'. A left-hand navigation menu includes 'Main', 'Network Setting', 'Tools', 'Administrator', and 'About'. The main content area has three tabs: 'General', 'Status', and 'Lens'. The 'Status' tab is active, showing a 'Lamp Info' table with the following data:

Lamp Info	
Lamp Hours	0000
Total Projector Hours:	0029
Lamp Reset	000

Below the table are four buttons: 'Lamp Info', 'Cooling', 'Version', and 'Signal'.

4.9.4 Main Tabbed Page – Lens

Control the focus, lens shift and zoom adjustments for the lens.

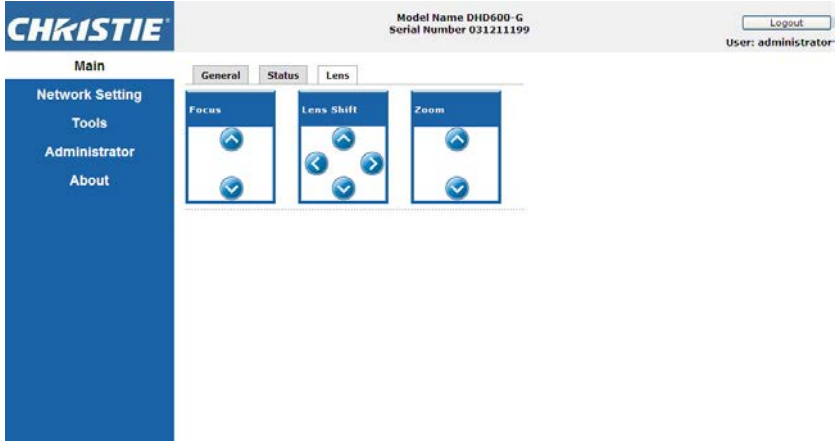

4.9.5 Network

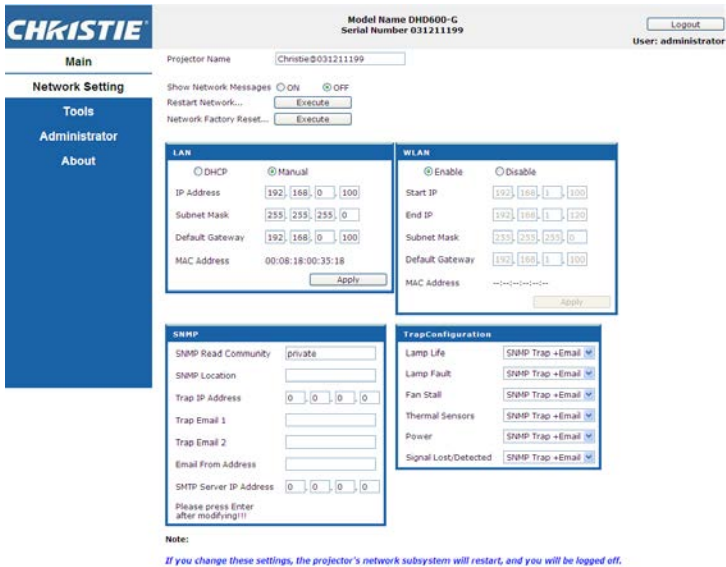

- Restart Network
Execute a Network restart. This will not change any of the network settings.
- Network Factory Reset
Execute a network factory reset. Network settings will be reset to the following default values:
 - Projector Name = Christie@ + Serial Number
 - Show Network Messages = ON
 - LAN Settings:
 - Manual
 - IP Address = 192.168.0.100
 - Subnet Mask = 255.255.255.0
 - Default Gateway = 192.168.0.100
 - WLAN Settings:
 - Enabled
 - Start IP = 192.168.1.100
 - End IP = 192.168.1.120
 - Subnet Mask = 255.255.255.0
 - Default Gateway = 192.168.1.100
 - SNMP Settings:
 - SNMP Read Communication = private
 - Trap IP Address = 0.0.0.0
 - SMTP IP Address = 0.0.0.0
 - All other settings are cleared/blanked
 - Trap Configuration:
 - All items = SNMP Trap + Email
- LAN Setting Panel
 - Select if the projector must obtain an automatically assigned IP address through DHCP or if the user will set the address manually.
 - Enter the IP address, netmask, default gateway and DNS server address for the TCP/IP setting.
- WLAN Setting Panel
 - Select if the wireless LAN of the projector is enabled or disabled.

- Enter the IP address range, netmask and default gateway for the wireless LAN.
- SNMP Panel
 - The G Series SNMP (Simple Network Management Protocol) interface provides network administrators with a common way to manage their network devices from a single remote location. SNMP allows an administrator to query a number of devices to see their current status/ configuration. It also allows operators to change configuration values and configure trap notifications to be sent when certain events occur. (eg. Loss of signal, power state change, etc)
 - ▶ Emails are sent to the mail server configured in the projector settings. Up to 2 user email accounts can be selected. Any important information regarding the event will be located in the body content of the email.
 - ▶ SNMP Traps are notifications that are sent from the projector. They are only received by a trap receiver (MIB Browser) in the computer.
 - SNMP Read Community (default setting: private) – this is a plain-text password. This must also be entered in the MIB browser. This password allows the various settings in the projector to be queried.
 - SNMP Location (default setting: blank) – This field can be used as a description to where a projector is located in a building. SNMP emails sent will specify this location.
 - Trap IP Address (default setting: 0.0.0.0) – This field must be filled in to receive Traps from the projector. The Trap IP Address should be filled in with the IP Address of the computer on which you would like to view received traps.
 - Trap Email 1/2 (default setting: Blank) – The Trap Email 1 and 2 must be set to an email address that is configured under the mail server that you will enter in the “SMTP Server IP Address” field.
 - Email from Address (default setting: blank) – the “Email from Address” that will appear as the source of the SNMP emails.
 - SMTP Server IP Address (default setting: 0.0.0.0) – Enter your mail server’s IP address.
- Trap Configuration Panel

Set the SNMP actions for the system events. The dropdown options are: SNMP Trap + Email, Email, SNMP Trap, and Disabled.

4.9.6 Tools

Use the Tools tabbed pages to control “Size & Position”, “Image Settings”, “Configuration”, “Lamp”, “Input Switching & PIP” and “Test Pattern”.

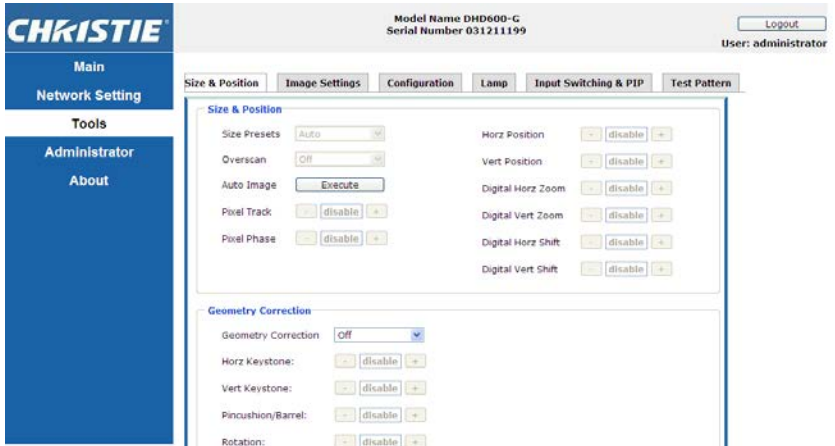

4.9.7 Administrator Page

Add or delete a user or change password

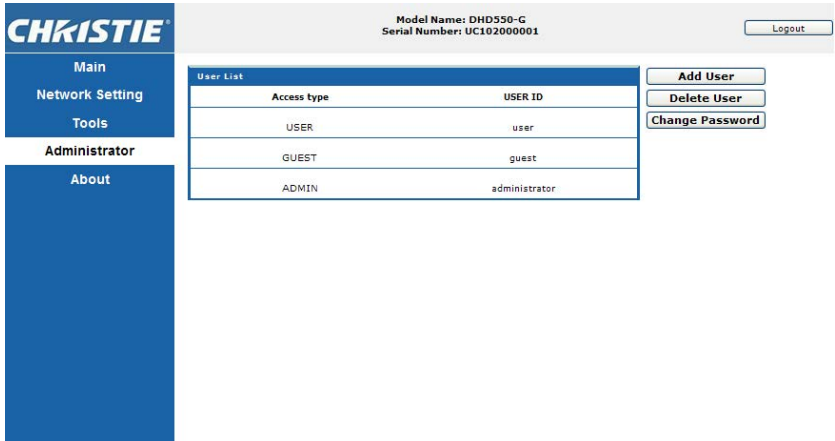

4.9.8 About Page



- **Version Tab**
View the main firmware version, network firmware version, projector model name, and projector serial number.
- **License Tab**
The license information of the computer program is displayed.

4.10 Christie Presenter

The Christie Presenter application allows a remote desktop from a host PC to be displayed on the network display through Ethernet, USB, or wireless transports. It can adapt to different network settings (DHCP, fixed IP, and direct link by USB/Ethernet cable).

Christie Presenter can be downloaded from the Christie website or from the web page of the projector.

4.10.1 Connect to the Projector

1. Connect to the projector using WiFi or Ethernet

- Ethernet connection:

- ▶ Determine the projector's IP address from the menu Main Menu > Configuration > Communications > LAN

LAN	
1. DHCP	<input type="checkbox"/>
2. IP Address	192.168.0.100
3. Subnet Mask	255.255.255.0
4. Default Gateway	192.168.0.254
5. MAC Address	00:08:18:00:35:18

- ▶ Configure your PC IP address to be on the same network as the projector.
- ▶ The projector and computer must be connected directly or over the network via Ethernet.

- WiFi Wireless connection:

- ▶ Insert the WiFi USB dongle (1DWUSB-BGN) into the USB port on the projector input panel.

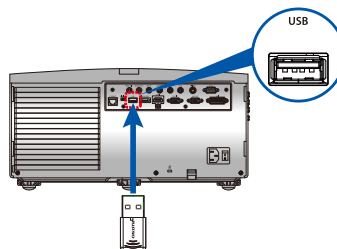

Insert the WiFi USB dongle

- ▶ Power on the Projector.
- ▶ Obtain the WiFi SSID from the OSD menu Main Menu > Configuration > Communications > WLAN
- ▶ Connect your PC device to the wireless SSID for the selected projector . Example: “Christie@0111000123”.



4.10.2 Install Christie Presenter software

1. Use a web browser to connect to the projector’s network address (Default address 192.168.1.100)
2. Download and install the Christie Presenter Software

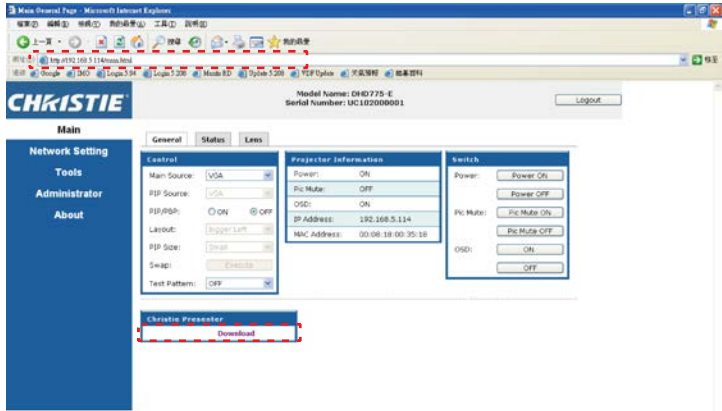

3. Configure the Christie Presenter Software. The name entered is used to identify all computers connected to the projector via the Christie Presenter software via either wired or wireless connections. The Network Display Management -> Device Management tab will show all current connections.

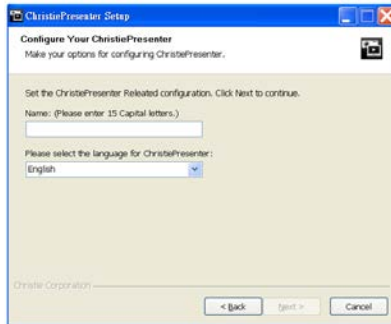







4.10.3 Use Christie Presenter

1. Press the autorun icon in the system tray to pause or play the USB display.



2. After starting the Christie Presenter application, the main window can be seen (shown below).



Icon	Description
	Connect and search network display
	Stop/start displaying desktop contents to connected network display
	Select display region
	Configure Christie Presenter
	Manage all connected network displays
	Disconnect all connections

Connect and search network display

1. Click the button  to enter into the connection menu section.

2. If the IP address of the projector is known, enter the IP address and click the "Connect" button. If the IP address is not known, click the "Search" button to search for the projector on the network and select the projector to which you want to connect. Select the option "Directly" in order to proceed to the log in interface.

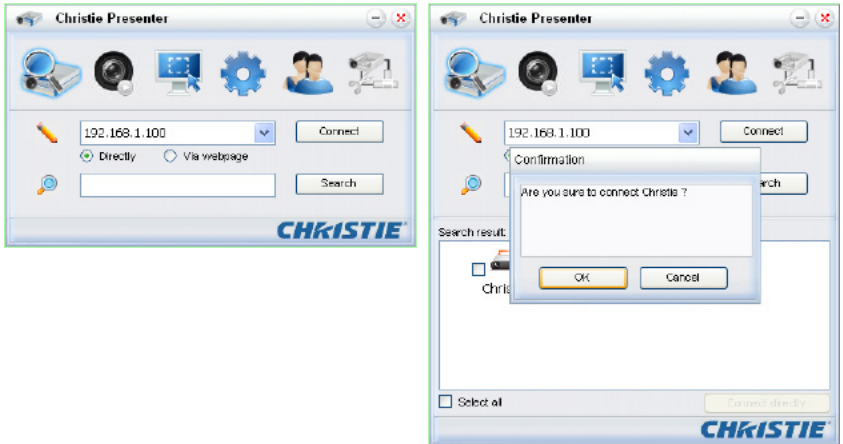

3. Input "User type" and "Password" in the log-in interface. Select the display port (the default is full screen). Obtain the " Normal " user's password from the OSD menu Main Menu > Configuration > Communications > WLAN.



Select display region

Once the connection is set up, click the button  to select the size of the projection region: FullScreen, FixedSize, or Alterable.

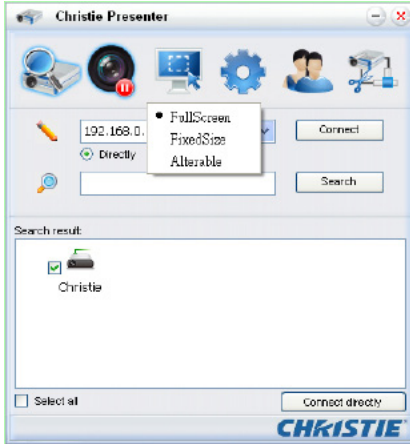

- FullScreen: The default capture mode turns to Full screen when the program is launched. At that time, if screen capture starts, the image of the whole screen is transferred to a remote network display.
- FixedSize: FixedSize mode allows the users to place a frame on the desktop. Only the image enclosed inside the frame is transferred to remote network display.
- Alterable: In Alterable mode the only region captured is the one enclosed by the frame. The region can be enlarged or downsized by dragging the eight small black squares scattered on eight edges of the frame.

Configure Christie Presenter

Click the button  to configure Christie Presenter for Basic Setting and Advanced Setting.

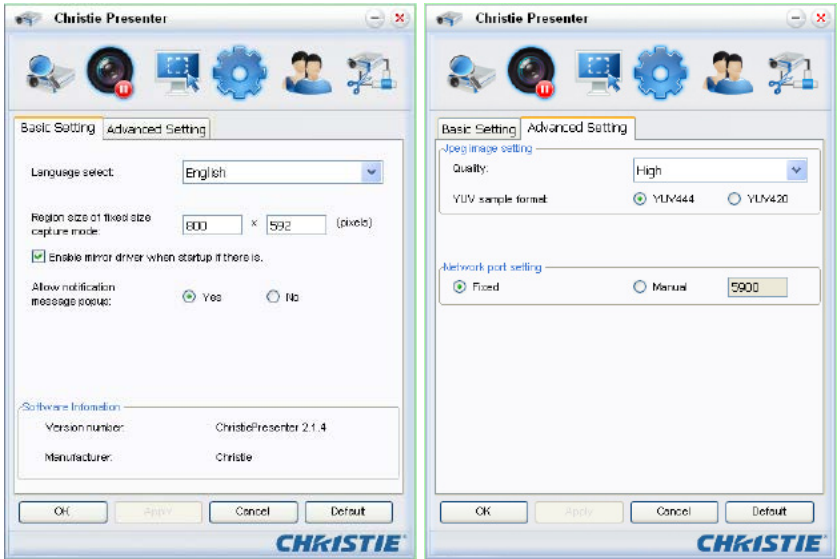







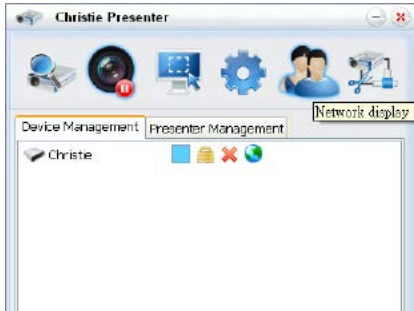

- Basic Setting: Select language, change the region size of fixed size capture mode, and select if notification message popup is allowed.
- Advanced Setting: Select the quality of JPEG image, YUV sample format and network port setting. (The "Fixed" port is Port 5900)

Manage all connected network displays

Click the button  to control all the users and all the projectors connector to the same projector.



Icon	Description
	Administrator log in.
	Normal user log in.
	Device is connected.
	Device is not connected.
	The icon shows the current status and display position of the local screen on the network display. Click on the icon to change the display position. A dialog box will appear.
	Click this unlock icon to change the password. (Password change to target network display. Only an Administrator user can change the password.)
	No response is expected when this icon is clicked. If user log in as "Admin", the key icon can be seen and the Presenter password can be changed. If user log in as "Normal", the lock icon can be seen and the Presenter password can't be changed.
	Disconnect from target network display.
	Link for connecting to a target network display via a webpage.

4.11 Card Reader Operation

There are four operation modes in the Card Reader application:

- USB Flash Devices Detection Screen
- Thumbnail Display Mode
- Images Display Mode
- Images Slide Show Mode

1. USB Flash Device Detection Screen:

In this mode, the Card Reader application detects any USB flash devices hot-plug events and displays the flash device icon. When the flash device is removed from USB, the icon disappears. It is suggested that USB flash devices should be removed only when the Card Reader is changed to the USB Flash Devices Detection Screen state.

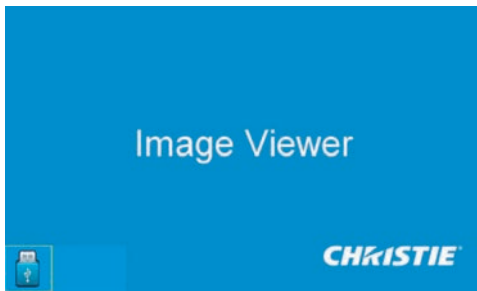

2. Thumbnail Display Mode:

Press the Enter key to enter the Thumbnail Display Mode. Different photos in different folders can be chosen. Press the Menu key to bring up the Card Reader operation UI.

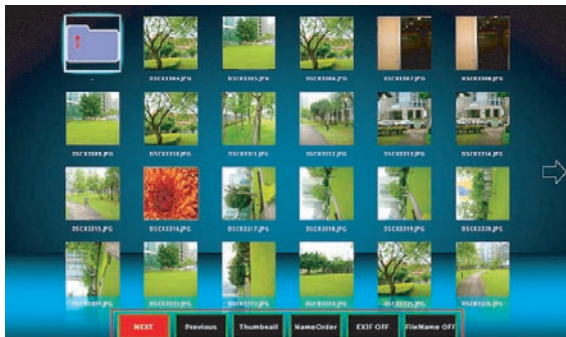

The user interface is designed to operate the card reader application with a few keys (Enter/Left/Right/Up/Down).

The following buttons are supported in the user interface:

- Previous: Move the selected item left. (Go to previous page when this is the leftmost item)
- Next: Move the selected item right. (Go to next page when this is the rightmost item.)
- Display: Display the selected image or display the selected folder.
- Thumbnail: Enter the Thumbnail Display Mode.
- SlideShow: Enter the Slide Show Mode.
- NameOrder: Sort files/folders in name order.
- ExtendOrder: Sort files/folders in extended order.
- SizeOrder: Sort files/folders in size order.
- TimeOrder: Sort files/folders in time order.
- EXIF ON/OFF: Enable/Disable auto image rotate accordingly to EXIF information.
- FileName ON/OFF: Enable/Disable filename display in Thumbnail Display Mode.

3. Image Display Mode:

Press the ENTER key in the Thumbnail Display Mode to enter the Image Display Mode; press the SlideShow key to enter the Slide Show Mode.

The Left/Right key is used to display the last/next image in the Image Display Mode. In the Image Display Mode, press the ENTER key to quit from the Image Display Mode and enter the Thumbnail Display Mode.

In the Slide Show Mode, press the ENTER key to enter the Image Display Mode.



The alternative way to display image in the Image Display Mode or Slide Show Mode is using the operation UI.

The following operations are supported in the operation UI.

- Display: Enter the Image Display Mode.
- Thumbnail: Enter the Thumbnail Display Mode.
- SlideShow: Enter the Slide Show Mode.
- Actual Size: Display in actual size of the image.
- Best Fit: Display the image in best fit to the screen.
- EXIFDisp OFF/On: Enable/Disable EXIF information display.
- +90deg: Rotate 90 degree.
- -90deg: Rotate -90 degree.



4. Image Slide Show Mode:

The following operations are supported in the Slide Show Mode operation UI.

- Stop: Stop Slide Show Mode.
- Next: Display next image.
- Previous: Display previous image.
- Delay 3/4/5: Slide Show delay in seconds.
- Slide Effect: Following modes are supported.
 - o Slide Right
 - o Blocks
 - o RightDown
 - o XLines
 - o Slide Up
 - o Ylines
 - o Repeat ON/OFF: Enable/Disable Slide Show Repeat Mode.



When the image can NOT be displayed due to memory limitation or can NOT support image format, the specific image is displayed on the center of the screen.

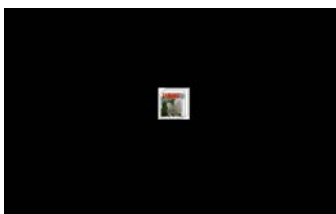

4.12 Install the Lamp

The projector automatically detects the lamp life. When the lamp life is nearing the end of use, you will receive a warning message. "When you see this message, please change the lamp as soon as possible." Make sure the projector has been cooled down for at least 30 minutes before changing the lamp.

Installation Steps:

1. **Turn off the lamp:** Turn the projector OFF and disconnect the power cord.

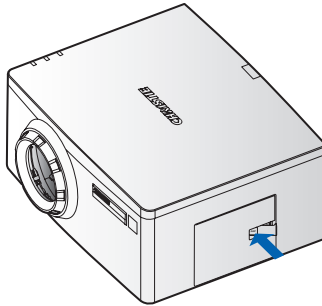

2. **Wait for lamp to cool down:** Allow the projector to cool down for at least 30 minutes.

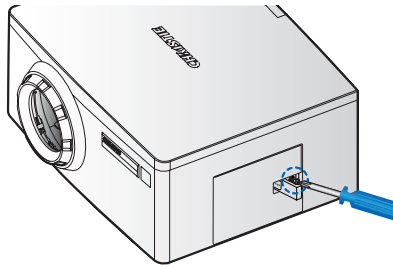

3. **Open the lamp door:** Push the door latch to open lock. Loosen the captive screw securing the lamp door. Open the lamp door.

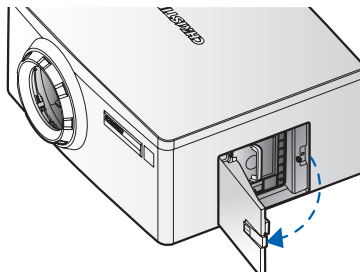

4. **Remove the old lamp:** Loosen the three captive screws securing the lamp. Remove the lamp module slowly and carefully.

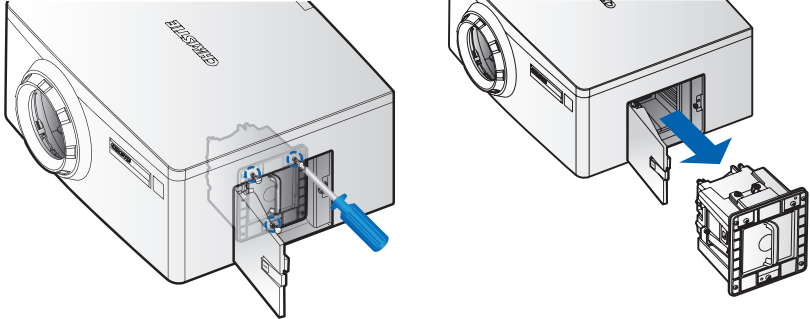

5. **Install the new lamp:** Replace the lamp with a new one and tighten the three screws. Make sure the lamp is set properly and secure.
6. **Close the lamp door:** Secure the captive screw. Put the lamp door back.
7. **Reset the lamp hours:** Turn the projector ON and use "Reset Lamp Hours" after the lamp module is replaced.
8. **Once "Reset Lamp Hours" is pressed, a pop up check box will be shown on screen to ask user to process Auto Brightness Calibration.**
It is strongly recommend to do Auto Brightness Calibration after changing lamp to achieve best accuracy of Constant Intensity control.

5. TROUBLESHOOTING

If you are unable to resolve an issue using the information provided in this section, contact your reseller or service center.

Problem	Solution
<ul style="list-style-type: none"> • No image appears on-screen 	<ul style="list-style-type: none"> - Make sure all the cables and power connections are correctly and securely connected See “Installation”. - Check if the lamp is securely installed. - Make sure you have removed the lens cap and the projector is switched ON.
<ul style="list-style-type: none"> • Partial, scrolling or incorrectly displayed image 	<ul style="list-style-type: none"> - Press “AUTO” on control panel or on remote control. - If you are using a PC (for Windows 95, 98, 2000, XP, Windows 7): <ol style="list-style-type: none"> 1. Click the “My Computer” > “Control Panel” and then double - click “Display”. 2. Select the “Settings” tab. 3. Verify that your display resolution setting is lower than or equal to WUXGA (1920 × 1200). 4. Click on the “Advanced Properties” button. If the projector is still not projecting the whole image, change the monitor display: <ol style="list-style-type: none"> 4.1 Verify the resolution setting is lower than or equal to WUXGA (1920 × 1200). 4.2 Select the “Change” button under the “Monitor” tab. 4.3 Click on “Show all devices”. Next, select “Standard monitor types” under the SP box; choose the resolution mode you need under the “Models” box. 4.4 Verify that the resolution setting of the monitor display is lower than or equal to WUXGA (1920 × 1200).

Problem	Solution																				
<ul style="list-style-type: none"> Partial, scrolling or incorrectly displayed image 	<ul style="list-style-type: none"> If you are using a Notebook: <ol style="list-style-type: none"> Adjust resolution of the computer. Press the keys listed below for your notebook manufacturer to send signal out from notebook to projector. Example: [Fn]+[F4] <table border="1" data-bbox="389 395 966 882"> <thead> <tr> <th>Notebook Brand</th> <th>Function Keys</th> </tr> </thead> <tbody> <tr> <td>Acer</td> <td>[Fn]+[F5]</td> </tr> <tr> <td>Asus</td> <td>[Fn]+[F8]</td> </tr> <tr> <td>Dell</td> <td>[Fn]+[F8]</td> </tr> <tr> <td>Gateway</td> <td>[Fn]+[F4]</td> </tr> <tr> <td>IBM/Lenovo</td> <td>[Fn]+[F7]</td> </tr> <tr> <td>HP/Compaq</td> <td>[Fn]+[F4]</td> </tr> <tr> <td>NEC</td> <td>[Fn]+[F3]</td> </tr> <tr> <td>Toshiba</td> <td>[Fn]+[F5]</td> </tr> <tr> <td>Mac Apple</td> <td>System Preference ⇒ Display ⇒ Arrangement ⇒ Mirror display</td> </tr> </tbody> </table> If you experience difficulty changing resolutions or your monitor freezes, restart all equipment including the projector. 	Notebook Brand	Function Keys	Acer	[Fn]+[F5]	Asus	[Fn]+[F8]	Dell	[Fn]+[F8]	Gateway	[Fn]+[F4]	IBM/Lenovo	[Fn]+[F7]	HP/Compaq	[Fn]+[F4]	NEC	[Fn]+[F3]	Toshiba	[Fn]+[F5]	Mac Apple	System Preference ⇒ Display ⇒ Arrangement ⇒ Mirror display
Notebook Brand	Function Keys																				
Acer	[Fn]+[F5]																				
Asus	[Fn]+[F8]																				
Dell	[Fn]+[F8]																				
Gateway	[Fn]+[F4]																				
IBM/Lenovo	[Fn]+[F7]																				
HP/Compaq	[Fn]+[F4]																				
NEC	[Fn]+[F3]																				
Toshiba	[Fn]+[F5]																				
Mac Apple	System Preference ⇒ Display ⇒ Arrangement ⇒ Mirror display																				
<ul style="list-style-type: none"> The screen of the Notebook or PowerBook computer is not displaying your presentation 	<ul style="list-style-type: none"> If you are using a Notebook PC Some Notebook PCs may deactivate their own screens when a second display device is in use. Each of them has a different method of reactivation. Please refer to your computer manual for detailed information. 																				
<ul style="list-style-type: none"> Image is unstable or flickering 	<ul style="list-style-type: none"> Use “Pixel Track” and “Pixel Phase” to correct it. Change the monitor color setting on your computer. 																				
<ul style="list-style-type: none"> Image has vertical flickering bar 	<ul style="list-style-type: none"> Use “Auto Image” to make an adjustment. Check and reconfigure the display mode of your graphic card to make it compatible with the projector. 																				

Problem	Solution
<ul style="list-style-type: none"> Image is out of focus 	<ul style="list-style-type: none"> - Make sure both lens caps (front and back) are removed. - Adjust lens focus to fit. - Make sure the projection screen is between the required distance.
<ul style="list-style-type: none"> The image is stretched when displaying 16:9 DVD title 	<ul style="list-style-type: none"> - When you play anamorphic DVD or 16:9 DVD, the projector will show the best image when the projector display mode is set to 16:9 in the OSD. - If you play 4:3 format DVD titles, please change the format to 4:3 in the projector OSD. - If the image is still stretched, you will also need to adjust the aspect ratio by setting the display format as 16:9 (wide) aspect ratio type on your DVD player.
<ul style="list-style-type: none"> Image is too small or too large 	<ul style="list-style-type: none"> - Adjust lens zoom to fit. - If it does not fill the screen properly, verify that the correct lens is in use or change the position of the projector.
<ul style="list-style-type: none"> Lamp burns out or makes a popping sound 	<ul style="list-style-type: none"> - If the lamp burns out, try power cycling the projector. If the lamp doesn't fire or if you hear it make a loud pop, the projector will not turn on until the lamp module has been replaced.

6. SPECIFICATIONS

6.1 Inputs

Signal Type	Resolution	Frame Rate (Hz)	HDMI	VGA	DisplayPort	DVI	Component	S- video	CVBS
PC	640x350	85	•		•				
	640x400	85	•	•		•			
	640x480	59	•						
	640x480	60	•	•	•	•			
	640x480	72	•	•		•			
	640x480	75	•	•	•	•			
	640x480	85	•	•	•	•			
	720x400	85	•	•		•			
	768x480	60	•						
	768x480	75	•						
	768x480	85	•						
	800x600	50	•		•				
	800x600	56	•	•		•			
	800x600	60	•	•	•	•			
	800x600	72	•	•		•			
	800x600	75	•	•	•	•			
	800x600	85	•	•	•	•			
	848x480	50	•						
	848x480	60	•						
	848x480	75	•						
	848x480	85	•						
	960x600	50	•						
	960x600	60	•		•				
	960x600	75	•						

NOTE:
❖ "RB" means "reduced blanking".

Signal Type	Resolution	Frame Rate (Hz)	HDMI	VGA	DisplayPort	DVI	Component	S- video	CVBS
PC	960x600	85	•						
	1024x768	60	•	•	•	•			
	1024x768	75	•	•	•	•			
	1024x768	85	•	•	•	•			
	1064x600	50	•						
	1064x600	60	•						
	1064x600	75	•		•				
	1064x600	85	•		•				
	1152x720	50	•						
	1152x720	60	•						
	1152x720	75	•						
	1152x720	85	•		•				
	1152x864	60	•	•			•		
	1152x864	70	•	•			•		
	1152x864	75	•	•			•		
	1152x864	85	•	•			•		
	1280x720	50	•			•			
	1280x720	60	•	•	•	•	•		
	1280x720	75	•	•	•	•	•		
	1280x720	85	•	•	•	•	•		
	1280x768	60	•	•			•		
	1280x768	75	•	•			•		
	1280x768	85	•	•			•		
	1280x800	50	•	•	•	•	•		
	1280x800	60	•	•	•	•	•		
	1280x800	75	•	•			•		
	1280x800	85	•	•			•		

Signal Type	Resolution	Frame Rate (Hz)	HDMI	VGA	DisplayPort	DVI	Component	S- video	CVBS
PC	1280x960	60	•	•		•			
	1280x960	75	•	•		•			
	1280x960	85	•	•		•			
	1280x1024	50	•		•				
	1280x1024	60	•	•	•	•			
	1280x1024	75	•	•	•	•			
	1280x1024	85	•	•	•	•			
	1360x768	50	•						
	1360x768	60	•						
	1360x768	75	•						
	1360x768	85	•						
	1366x768	60	•	•	•	•			
	1400x900	60	•	•	•	•			
	1400x1050	50	•		•				
	1400x1050	60	•	•	•	•			
	1400x1050	75	•	•		•			
	1440x900	60	•	•		•			
	1440x900	75	•						
	1600x900	60	•						
	1600x1200	50	•						
	1600x1200	60	•	•	•	•			
	1680x1050	50	•		•				
	1680x1050	60	•	•	•	•			
	1680x1050	75	•						
	1704x960	50	•						
	1704x960	60	•						
	1728x1080	50	•						

Signal Type	Resolution	Frame Rate (Hz)	HDMI	VGA	DisplayPort	DVI	Component	S- video	CVBS
PC	1728x1080	60	•						
	1864x1050	50	•						
	1864x1050	60	•						
	1920X1080	50	•		•				
	1920X1080	60	•	•		•			
	1920X1200RB	60	•	•	•	•			
	1920X1200RB	50	•	•	•	•			
NTSC	NTSC (M, 4.43)	60						•	•
PAL	PAL (B,G,H,I)	50						•	•
	PAL (N)	50						•	•
	PAL (M)	60						•	•
SECAM	SECAM (M)	50						•	•
	480i	60	•	•		•	•		
	576i	50	•	•		•	•		
EDTV	480p	60	•	•		•	•		
	576p	50	•	•		•	•		

Signal Type	Resolution	Frame Rate (Hz)	HDMI	VGA	DisplayPort	DVI	Component	S- video	CVBS
HDTV	1080i	25	•	•		•	•		
	1080i	29	•	•		•	•		
	1080i	30	•	•		•	•		
	720p	50	•	•		•	•		
	720p	59	•	•		•	•		
	720p	60	•	•		•	•		
	1080s	23	•				•		
	1080s	24	•				•		
	1080p	23	•	•		•	•		
	1080p	24	•	•		•	•		
	1080p	25	•	•		•	•		
	1080p	29	•	•		•	•		
	1080p	30	•	•		•	•		
	1080p	50	•	•		•	•		
	1080p	59	•	•		•	•		
	1080p	60	•	•		•	•		

6.2 PIP/PBP Compatibility

Main PIP/PBP	HDMI	DVI-D	VGA	Component	S-Video	CVBS	RJ45	USB Type B (mini)	USB Type A	Display- Port
HDMI	-	•	-	-	-	•	•	•	•	•
DVI-D	•	-	•	•	•	•	-	-	-	-
VGA	-	•	-	-	-	-	•	•	•	•
Component	-	•	-	-	-	-	•	•	•	•
S-Video	-	•	-	-	-	-	•	•	•	•
CVBS	-	•	-	-	-	-	•	•	•	•
RJ45	•	-	•	•	•	•	-	-	-	-
USB Type B (mini)	•	-	•	•	•	•	-	-	-	-
USB Type A	•	-	•	•	•	•	-	-	-	-
DisplayPort	•	-	•	•	•	•	-	-	-	-

• : PIP/PBP combinations are enabled

- : PIP/PBP combinations are disabled

6.3 Key Features

- WXGA 0.65" 1280 x 800 or HD 0.65" 1920 x 1080 resolution or WUXGA 0.67" 1920 x 1200 resolution
- Projection lens compatibility:
 - Horizontal offset ranges: +/-20%
 - Vertical offset ranges: +/-100% (WUXGA/WXGA) and +/-120% (HD)
- *NOTE:*
❖ *Measurements are based on industry standards where offset is calculated as a ratio of the number of pixels shifted up/down to half the image size.*
- Dynamic aperture enabled (full white to full dark contrast ratio): 5000:1 (Nominal)
- Dual Processing Warp Module for edge blending and geometric correction. (Optional)
- Wireless desktop display using wireless dongle (optional)
- SNMP traps and e-mail notifications
- Single mercury lamp illumination with 465W (DWH600-G/DHD600-G/DWU600-G)
- 10-bit image processor electronics with modular design
- All video formats can be resized to full screen either horizontally or vertically while maintaining aspect ratio
- The projector can be operated using any of the following:
 - The built-in keypad, an infrared (IR) remote control, a wired remote control, a PC/device using serial communications (Ethernet or RS232)
 - A Web page via Ethernet or from a PC/device via a wireless USB dongle. (Optional)
- Weight:
 - Maximum product weight (with lens removed): 15kg (33lb.)
- Built-In keypad

6.4 List of Components

This projector comes with all the items shown below. Check to make sure your package is complete. Contact your dealer if anything is missing.

- IR remote control 003-004468-01
- Power cord x 4
 - UK/Korea/Russia
 - North America
 - Europe
 - Japan
- User manual (CD)
- Lens 1.22-1.52 Zoom G (140-100102-01)

NOTE:

❖ *Due to the difference in applications for each country, some regions may have different accessories.*

6.5 Optional Accessories

- Lens 0.75-0.95 Zoom G (140-119102-01)
- Lens 0.95-1.22 Zoom G (140-101103-01)
- Lens 1.52-2.89 Zoom G (140-102104-01)
- Lens 2.90-5.50 Zoom G (140-107109-01)
- Cable Cover G White (140-103105-01)
- 1DWUSB-BGN / Wireless dongle (optional accessory) (133-113106-01)
- Dual Processor Warp Module (optional accessory) (133-111104-01)

6.6 REGULATORY

- Safety
 - CSA C22.2 No. 60950-1
 - UL 60950-1
 - IEC 60950-1
 - EN 60950-1
- Electro-Magnetic Compatibility
 - Emissions
 - FCC CFR47, Part 15, Subpart B/ANSI C63.4, Class A – Unintentional Radiators
 - CISPR 22/EN55022 Class A - Information Technology Equipment
 - ICES/NMB003 (A) - Information Technology Equipment
 - Immunity
 - CISPR 24/EN55024 EMC Requirements - Information Technology Equipment
- Environmental
- The product conforms to:
 - EU Directive (2011/65/EU) on the restriction of the use of certain hazardous substances (RoHS) in electrical and electronic equipment and the applicable official amendment(s).
 - EU Regulation (EC) No. 1907/2006 on the registration, evaluation, authorization and restriction of chemicals (REACH) and the applicable official amendment(s).
 - EU Directive (2012/19/EU) on waste and electrical and electronic equipment (WEEE) and the applicable official amendment(s).
 - China Ministry of Information Industry Order No.39 (02/2006) on the control of pollution caused by electronic information products, the hazardous substances concentration limits (SJ/T11363-2006), and the applicable product marking requirement (SJ/T11364-2006).
- Marking
 - This product conforms to all relevant Canadian, US, and European directives, standards, safety, health and environmental concerns. International packaging recycling marks conform to:
 - ▶ EU Directive (2012/19/EU) on waste and electrical and electronic equipment (WEEE) .
 - ▶ EU Directive (94/62/EC) on packaging and packaging waste
 - ▶ China packaging recycling mark standard (GB18455-2001)

6.7 Federal Communications Commission (FCC) Warning

⚠ WARNING

- A shielded-type power cord is required in order to meet FCC emission limits and also to prevent interference to the nearby radio and television reception. It is essential that only the supplied power cord be used.
- Use only shielded signal cables to connect I/O devices to this equipment.

6.8 OSD Tree

Level 1	Level 2	Level 3(Or List)	Level 4(Or List)	Level 5(Or List)	Level 6(Or List)	Default		
Size & Position	Size Presets	Auto				Auto		
		Native						
		4:3						
		Letterbox						
		Full Size						
		Full Width						
		Full Height						
	Overscan	Custom						
		Off				By source set		
		Zoom						
	Crop							
	Pixel Track	0 - 100				50		
	Pixel Phase	0 - 100				50		
	Horz Position	0 - 100				50		
	Vert Position	0 - 100				50		
	Digital Horz Zoom	50%~400%				100		
	Digital Vert Zoom	50%~400%				100		
	Digital Horz Shift	0 - 100				50		
	Digital Vert Shift	0 - 100				50		
		Off				Off		
		Geometry Correction	Horz Keystone	Horz Keystone	0 - 100 (0-20 for GEO model)		50 (10 for GEO model)	
				Vert Keystone	0 - 100 (0-20 for GEO model)		50 (10 for GEO model)	
				Horz Pincushion	0 - 100		50	
				Vert Pincushion	0 - 100		50	
				Pincushion/Barrel	0-20		10	
			Basic	4-Corner	Top Left Horz adjust.		0-140	0
					Top Left Vert adjust.		0-80	0
					Top Right Horz adjust.		0-140	0
					Top Right Vert adjust.		0-80	0
					Bottom Left Horz adjust.		0-140	0
					Bottom Left Vert adjust.		0-80	0
					Bottom Right Horz adjust.		0-140	0
	Bottom Right Vert adjust.					0-80	0	
	Curve	Curve	Top Arc		0-400	200		
			Bottom Arc		0-400	200		
			Left Arc		0-400	200		
			Right Arc		0-400	200		
		4-Corner	Top Left Horz adjust.		0-160	0		
			Top Left Vert adjust.		0-80	0		
			Top Right Horz adjust.		0-160	0		
			Top Right Vert adjust.		0-80	0		

Level 1	Level 2	Level 3(Or List)	Level 4(Or List)	Level 5(Or List)	Level 6(Or List)	Default		
Size & Position	Geometry Correction	Curve	4-Corner	Bottom Left Horz adjust.	0-140	0		
				Bottom Left Vert adjust.	0-80	0		
				Bottom Right Horz adjust.	0-140	0		
				Bottom Right Vert adjust.	0-80	0		
		Rotate	4-Corner	Rotation		0-16		8
				Top Left Horz adjust.	0-140	0		
				Top Left Vert adjust.	0-80	0		
				Top Right Horz adjust.	0-140	0		
				Top Right Vert adjust.	0-80	0		
				Bottom Left Horz adjust.	0-140	0		
				Bottom Left Vert adjust.	0-80	0		
				Bottom Right Horz adjust.	0-140	0		
				Bottom Right Vert adjust.	0-80	0		
				Auto Image	command			
Image settings	Brightness	0 - 100				50		
	Contrast	0 - 100				By source set		
	Color Space	Auto					Auto	
		RGB	RGB				RGB	
			RGB Video					
			REC709					
		YUV	REC709					REC709
	REC601							
	Detail	Maximum					By source set	
		High						
		Normal						
		Low						
		Minimum						
	Video Options	Color	0 - 100				50	
		Tint	0 - 100				50	
		Noise Reduction	0 - 100				0	
		Flesh Tone Correction	0 - 100				0	
		Video Black Level						
		Detect Film	Off/On				Off	
		Closed captions	Off					Off
cc1								
cc2								
Input Levels		Red Gain	0 - 100				50	
	Green Gain	0 - 100				50		
	Blue Gain	0 - 100				50		
	Red Offset	0 - 100				50		
	Green Offset	0 - 100				50		
	Blue Offset	0 - 100				50		
	Sync Threshold	0 - 100				50		
	Reset RGB Gain/Offset	command						

Level 1	Level 2	Level 3(Or List)	Level 4(Or List)	Level 5(Or List)	Level 6(Or List)	Default		
Image settings	Picture Settings	Presentation				By source set		
		Video						
		Bright						
		Whiteboard						
		Blackboard						
		Beige Wall						
		Real						
		DICOM SIM						
	Save to User	User						
	DynamicBlack	command				Off		
	Image Freeze	Off / On				Off		
	Advanced Image Settings	Gamma	Video				By source set	
			Film					
			Bright					
			CRT					
			DICOM					
		BrilliantColor™	Normal Look				Bright	
			Bright Look					
		White Peaking	0 - 100				By source set	
		Color Temperature	Edge Enhancement	Warmest				By source set
				Warm				
				Cool				
				Bright				
Edge Enhancement		Color Wheel Speed	Off				Off	
			Normal					
			Maximum					
			2X				2X	
		3X						
	Color Enhancement	Off				CE1		
		CE 1						
		CE 2						
Configuration	Language	SPEC define				English		
	Lens settings	Focus	command					
		Zoom	command					
		Lens Shift	command					
		Lock all Lens Motors	Allow				Allow	
			Locked					
		Lens center calibration	command					
	Ceiling Mount	Off/On/Auto				Auto		
	Rear Projection	Off/On				Off		
	Menu Preferences	Menu Horz Offset	Menu Horz Offset	0 - 100			0	
			Menu Vert Offset	0 - 100			0	
			Show Messages	off/on			on	
			Menu Transparency	0 - 90			0	
		Splash Screen Setup	PIN Protect	Factory Logo				Factory Logo
				Blue				
Black								
			White					
	Change PIN	command						

Level 1	Level 2	Level 3(Or List)	Level 4(Or List)	Level 5(Or List)	Level 6(Or List)	Default
Configuration	Power Management	Standby Mode	0.5 W Mode			Communication mode
			Communication Mode			
		AC Power On	off/on			off
			Never			
		Auto shutdown	5 Mins			Never
			10 Mins			
			15 Mins			
			20 Mins			
			25 Mins			
			30 Mins			
	Sleep Timer	Off			Off	
		2 Hrs				
		4 Hrs				
		6 Hrs				
	High Altitude	Off/On			Off	
	Communications	LAN	DHCP			by set
			IP Address			
			Subnet Mask			
			Default Gateway			
			MAC Address			
		WLAN	Enable			by set
			Start IP			
			End IP			
			Subnet Mask			
			Default Gateway			
			MAC Address			
			SSID			
		Network	Projector Name			by set
			Show Network Messages			
			Restart Network...			
			Network Factory Reset...			
		Serial Port Baud Rate	2400			115200
			4800			
9600						
14400						
19200						
38400						
57600						
115200						
1200						
Serial Port Echo	Off/On			Off		
Projector Address	0 - 9			0		
Image Blending	Blending	On/Off			Off	
	Marker	On/Off			Off	
	Grid	Off/White/Red/ Green/Blue			Off	
	Solid Color	Off/White/Red/ Green/Blue			Off	

Level 1	Level 2	Level 3(Or List)	Level 4(Or List)	Level 5(Or List)	Level 6(Or List)	Default		
Configuration	Image Blending	Overlap	TOP	0... ½ Output Height(Pixel)		0		
			Bottom	0... ½ Output Height		0		
			Left	0... ½ Output Width		0		
			Right	0... ½ Output Width		0		
		Bright Adj.	Blending Area offset	0-2000		1000		
			non-Blending Area Offset	0-2000		1000		
		Drop Off Curve	70-300			100		
		Image Gamma	1.8/2.0/2.2/2.4/2.6			2.2		
		Color Matching	Meter Adjustment	Enable	On/Off			Off
				Auto Test Pattern	On/Off			On
	Measured Data			Intensity of Red	100 - 10000		453	
				x of Red	0.300 - 0.700		0.633	
				y of Red	0.300 - 0.500		0.356	
				Intensity of Green	100 - 10000		2137	
				x of Green	0.300 - 0.400		0.352	
				y of Green	0.400 - 0.700		0.572	
				Intensity of Blue	100-10000		239	
				x of Blue	0.100 - 0.300		0.140	
				y of Blue	0.030 - 0.400		0.093	
				Intensity of White	100-10000		9219	
				x of White	0.200 - 0.400		0.331	
				y of White	0.200 - 0.400		0.380	
				Reset to Default	Yes/No			
				Target Data	Gain of Red	0.200 - 1.000		1.000
	x of Red				0.300 - 0.700		0.643	
	y of Red				0.300 - 0.500		0.344	
	Gain of Green				0.200 - 1.000		1.000	
	x of Green				0.300 - 0.400		0.329	
	y of Green				0.400 - 0.700		0.544	
	Gain of Blue				0.200 - 1.000		1.000	
	x of Blue				0.100 - 0.300		0.141	
	y of Blue				0.030 - 0.400		0.094	
	Gain of White				0.200 - 1.000		1.000	
	x of White				0.200 - 0.400		0.334	
	y of White				0.200 - 0.400		0.371	
	Reset to Default			Yes/No				
	Manual Adjustment			Enable	On/Off			Off
				Auto Test Pattern	On/Off			On
		Red Part of Red	0 - 1000			1000		
		Green Part of Red	0 - 1000			0		
		Blue Part of Red	0 - 1000			0		
		Green Part of Green	0 - 1000			1000		
Red Part of Green		0 - 1000			0			
Blue Part of Green		0 - 1000			0			
Blue Part of Blue		0 - 1000			1000			
Red Part of Blue		0 - 1000			0			
Green Part of Blue		0 - 1000			0			

Level 1	Level 2	Level 3(Or List)	Level 4(Or List)	Level 5(Or List)	Level 6(Or List)	Default	
Configuration	Color Matching	Manual Adjustment	Red Part of White	0 - 1000		1000	
			Green Part of White	0 - 1000		1000	
			Blue Part of White	0 - 1000		1000	
			Reset to Default	Yes/No			
	Hot-Key settings	Blank Screen					
		Aspect Ratio					
		Freeze Screen					
		Projector Info					
		Overscan					
		Closed Captions					
	Service	Projector Info	Model Name				
			Serial Number				
			Native Resolution				
			Firmware				
			Configuration				
			Boot Code				
			Standby Mode				
			Lens Lock Settings				
			Color wheel Index				
			FactoryReset...	command			
				Off			
				Grid			
				White			
				Black			
				Checkerboard			
				Color Bars			
				Red			
				Green			
				Blue			
				Yellow			
				Magenta			
				Cyan			
				Boresight			
			Color wheel Index (2x)	TBD			
			Color wheel Index (3x)	TBD			
		Error log	Show log				
			Clear log				
		Mode Adjustment					

Level 1	Level 2	Level 3(Or List)	Level 4(Or List)	Level 5(Or List)	Level 6(Or List)	Default	
Lamp	Lamp mode	Constant Power/ Constant Intensity/Eco mode				Constant Power	
	Constant Power	360 – 465				465	
	Constant Intensity	0 - 10				7	
	Lamp Info	Lamp Hours					
		Total Hours All Lamps					
		Lamp Reset					
	Lamp Life Setting	xxxxx				1500 hrs	
	Reset Lamp Hours...	command					
Light Sensor	Light Sensor Calibration		command				
	Calibrated?		(display Yes/No)				
Status	Model Name						
	Serial Number						
	Native Resolution						
	Firmware					Vxx, Ayy, Bzz	
	Main Input						
	Main Signal Format						
	Main Pixel Clock						
	Main Sync Type						
	Main Horz Refresh						
	Main Vert Refresh						
	PIP/PBP Input						
	PIP/PBP Signal Format						
	PIP/PBP Pixel Clock						
	PIP/PBP Sync Type						
	PIP/PBP Horz Refresh						
	PIP/PBP Vert Refresh						
	Lamp Power Settings						
	Lamp Hours						
	Standby Mode						
	Lens Lock Settings						
IP Address							
DHCP							
System Temperature							

Level 1	Level 2	Level 3(Or List)	Level 4(Or List)	Level 5(Or List)	Level 6(Or List)	Default	
Input Switching & PIP	Main Input	SPEC define					
	PIP/PBP Input	SPEC define					
	PIP/PBP Enable	OFF					OFF
		ON					
	Swap						
	Size	(Small/Medium/Large)					
	Main Layout	(PBP, Main Left / PBP, Main Top / PBP, Main Right / PBP, Main Bottom / PIP-Bottom Right / PIP-Bottom Left / PIP-Top Left / PIP-Top Right)					
	Timing Detection Mode	Normal					Wide
		Wide					
	Source Info	Active Source					
		Signal Format					
		Aspect Ratio					
		Resolution					
		Vert Refresh					
		Horz Refresh					
		Pixel Clock					
		Sync Type					
		Color Space					
		PIP/PBP		(When PIP/PBP active)			
	<PIP/PBP source lines>		(When PIP/PBP active)				
	Enable source Hot-Key	ON					ON
		OFF					
	Source Hot-Key	VGA					Key number 1
		HDMI					Key number 2
		DVI-D					Key number 3
		Display Port					Key number 4
		Component					Key number 5
		S-Video					Key number 6
		Composite					Key number 7
		Christie Presenter					Key number 8
		Card Reader					Key number 9
		Mini USB					Key number 0
Input key	Change Sources					Auto Source	
	List all Sources						
	Auto Source						
Blank on Signal Switch	OFF						
	ON						
Language	SPEC define					English	
Test pattern	Off						
	Grid						
	White						
	Black						
	Checkerboard						
	Color Bars						

6.9 Preset Mode tables

A30H-6SW(RYGCWB) CW														
Description	Bright Mode		Presentation Mode		Video Mode		Whiteboard Mode		Blackboard Mode		Beige Wall Mode		Dicom Mode	
CW	2X	3X	2X	3X	2X	3X	2X	3X	2X	3X	2X	3X	2X	3X
Syt. Mode Number	0	8	6	14	6	14	6	14	6	14	7	15	6	14
Waveform no	0	1	0	1	0	1	0	1	0	1	0	1	0	1
ColorTemp(default)	BRIGHT		WARM		WARM		WARM		WARM		COOL		WARM	
Bright	0	8	4	12	4	12	4	12	4	12	4	12	4	12
Warmes	1	9	5	13	5	13	5	13	5	13	5	13	5	13
Warm	2	10	6	14	6	14	6	14	6	14	6	14	6	14
Cool	3	11	7	15	7	15	7	15	7	15	7	15	7	15
Gamma	BRIGHT		FILM		FILM		BRIGHT		CRT		FILM		DICOM	
WhitePeaking	100		100		80		100		100		100		100	

Mode NO.	SQ	CT mode	OSD MODE	CT
0	2X-Bright	2X-Native	Bright	Bright
1	2X-Bright	2X-D55	Bright	Warmest
2	2X-Bright	2X-D65	Bright	Warm
3	2X-Bright	2X-D85	Bright	Cool
4	2X-Color	2X-Native	Presentation/Video/ Whiteboard/ Blackboard/ Beig/Wall/ Dicom	Bright
5	2X-Color	2X-D55		Warmest
6	2X-Color	2X-D65		Warm
7	2X-Color	2X-D85		Cool
8	3X-Bright	3X-Native		Bright
9	3X-Bright	3X-D55	Bright	Warmest
10	3X-Bright	3X-D65	Bright	Warm
11	3X-Bright	3X-D85	Bright	Cool
12	3X-Color	3X-Native	Presentation/Video/ Whiteboard/ Blackboard/ Beig/Wall/ Dicom	Bright
13	3X-Color	3X-D55		Warmest
14	3X-Color	3X-D65		Warm
15	3X-Color	3X-D85		Cool

OSD	Gamma index	SQ
CRT	6	Vivid
VIDEO	5	maxbright
FILM	0	film
Bright	4	Graphics
DICOM	13	Dicom

SIGNAL	Default Mode	IMAGE	Mode	Brightness	Contrast	Default Mode	IMAGE	Mode	Brightness	Contrast
Composite	Video Mode	PAL	Presentation Mode	50	50	Video Mode	NTSC	Presentation Mode	34	51
			Video Mode	50	50			Video Mode	34	51
			Bright Mode	50	50			Bright Mode	34	51
			Whiteboard Mode	50	50			Whiteboard Mode	34	51
			Blackboard Mode	50	50			Blackboard Mode	34	51
			Beige Wall Mode	50	50			Beige Wall Mode	34	51
			REAL Mode	50	50			REAL Mode	34	51
S-video	Video Mode	PAL	Presentation Mode	50	50	Video Mode	NTSC	Presentation Mode	34	51
			Video Mode	50	50			Video Mode	34	51
			Bright Mode	50	50			Bright Mode	34	51
			Whiteboard Mode	50	50			Whiteboard Mode	34	51
			Blackboard Mode	50	50			Blackboard Mode	34	51
			Beige Wall Mode	50	50			Beige Wall Mode	34	51
			REAL Mode	50	50			REAL Mode	34	51
VGA/PC	Presentation Mode	PC Signal	Presentation Mode	49	51	Video Mode	Component/Video (720p, 576p/i, 1080p/i, 480p/i....)	Presentation Mode	50	51
			Video Mode	49	51			Video Mode	50	51
			Bright Mode	49	51			Bright Mode	50	51
			Whiteboard Mode	49	51			Whiteboard Mode	50	51
			Blackboard Mode	49	51			Blackboard Mode	50	51
			Beige Wall Mode	49	51			Beige Wall Mode	50	51
			REAL Mode	49	51			REAL Mode	50	51
HDMI/DVI	Presentation Mode	PC Signal	Presentation Mode	50	50	Video Mode	HDMI/DVI (SD/HD)	Presentation Mode	36	54
			Video Mode	50	50			Video Mode	36	54
			Bright Mode	50	50			Bright Mode	36	54
			Whiteboard Mode	50	50			Whiteboard Mode	36	54
			Blackboard Mode	50	50			Blackboard Mode	36	54
			Beige Wall Mode	50	50			Beige Wall Mode	36	54
			REAL Mode	50	50			REAL Mode	36	54
DICOM Mode	50	50	DICOM Mode	36	54					

Corporate offices

USA – Cypress
ph: 714-236-8610

Canada – Kitchener
ph: 519-744-8005

Consultant offices

Italy
ph: +39 (0) 2 9902 1161

Worldwide offices

Australia
ph: +61 (0) 7 3624 4888

Brazil
ph: +55 (11) 2548 4753

China (Beijing)
ph: +86 10 6561 0240

China (Shanghai)
ph: +86 21 6278 7708

Eastern Europe and
Russian Federation
ph: +36 (0) 1 47 48 100

France
ph: +33 (0) 1 41 21 44 04

Germany
ph: +49 2161 664540

India
ph: +91 (080) 6708 9999

Japan
ph: 81-3-3599-7481

Korea (Seoul)
ph: +82 2 702 1601

Republic of South Africa
ph: +27 (0)11 510 0094

Singapore
ph: +65 6877-8737

Spain
ph: + 34 91 633 9990

United Arab Emirates
ph: +971 4 3206688

United Kingdom
ph: +44 118 977 8000



For the most current technical documentation,
please visit www.christiedigital.com

CHRISTIE®